

The *EXPOLIS* Databases

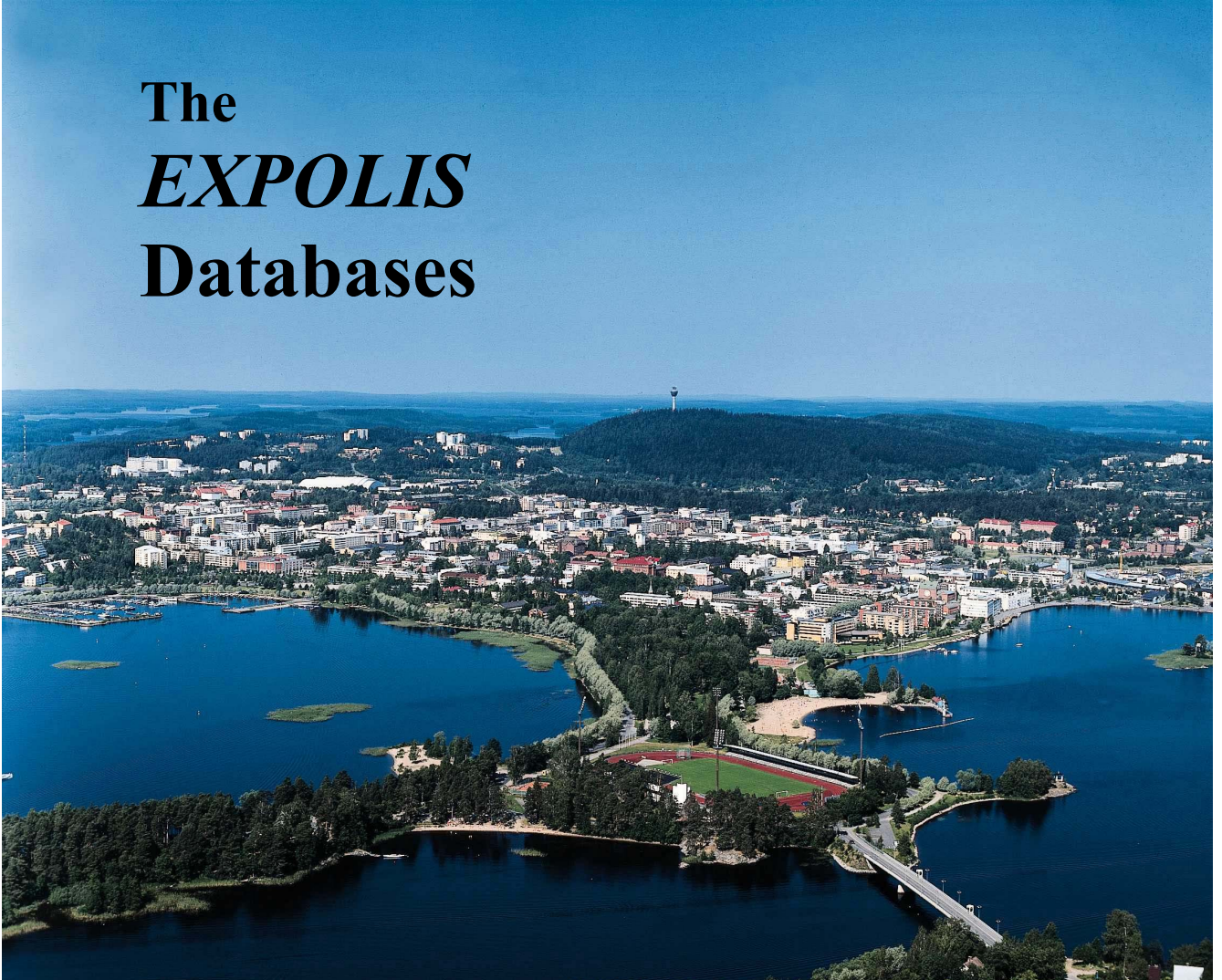

Otto Hänninen, Sari Alm, Esa Kaarakainen and Matti Jantunen

Kuopio, 2002



EXPOLIS DATABASES

Otto Hänninen, Sari Alm, Esa Kaarakainen, and Matti Jantunen

KTL, Department of Environmental Health

Kuopio, Finland
September 2002

Kansanterveyslaitoksen julkaisuja, B 13/2002
KTL Publications, B 13/2002

ISBN: 951-740-321-6 (printed)
ISBN: 951-740-322-4 (pdf-file)

ISSN: 0359-3576

CONTENTS

1. INTRODUCTION	9
1.1. SCOPE AND OBJECTIVES OF EXPOLIS	9
1.2. THE EXPOLIS CITIES	10
1.3. AIR POLLUTANTS	10
1.4. MICROENVIRONMENTS AND ACTIVITIES.....	10
1.5. POPULATION SAMPLES	11
1.6. MEASUREMENT SCHEME.....	12
1.6.1. PERSONAL AND MICROENVIRONMENT MEASUREMENTS	12
1.6.2. QUESTIONNAIRES AND TIME-ACTIVITY MONITORING	13
1.7. EXPOLIS DATABASE; EADB.....	13
1.8. QUALITY ASSURANCE	14
2. DATA MANAGEMENT	15
2.1. DATA MANAGEMENT GOALS.....	15
2.2. STRUCTURE OF THE EXPOLIS DATABASES CD-ROM.....	16
3. POPULATIONS AND SAMPLES	17
4. THE DATABASES	19
4.1. TOOL DATABASES AND LINKED TABLES.....	20
4.2. SECURITY POLICIES.....	21
4.3. QUERIES AND JOIN TYPES	21
4.4. FIELD-STAGE FORMS.....	22
4.5. VBA MODULES.....	22
5. CONCENTRATION QUERY NETWORKS	27
5.1. VOC CONCENTRATION CALCULATION.....	28
5.2. NO ₂ CONCENTRATION CALCULATION.....	29
5.3. PM _{2,5} CONCENTRATION CALCULATION.....	30
5.4. CO CONCENTRATION CALCULATION.....	32
5.5. BS CONCENTRATION CALCULATION.....	33
5.6. EAS CONCENTRATION CALCULATION	35
5.7. FIXEDRUNS CONCENTRATION CALCULATION	36

Figures

Figure 1. The Combined International Database consists of a subset of data from the Local databases in each city.	16
Figure 2. Data from each city contains information from different sources.....	16
Figure 3. The <i>EXPOLIS</i> Databases CD-ROM contains the main CIDB database file (in Access 95 and Access 97 formats), project (www-pages) and database documentation and the detailed Local databases created in each center.	19
Figure 4. Data and tool database files.	20
Figure 5. Queries combine data from tables, perform calculations and output new tables. Query outputs are dynamic – values are recalculated from source data when every the query is run.....	21
Figure 6. Inner join requires a record from both tables while outer join allows missing records in table 4 above.	21

Tables

Table 1. Customer id (cid) ranges.	17
Table 2. Number ranges for sample identification codes.	18
Table 3. <i>EXPOLIS</i> database files (size of Helsinki file as of Dec 2001).	20
Table 4. <i>EXPOLIS</i> database files and the VBA modules contained within.	23
Table 5. List of VBA functions and procedures contained in the <i>EXPOLIS</i> databases.	24
Table 6. Tables and queries used in calculating VOC concentrations.	28
Table 7. Formulas used in calculating the VOC concentrations.	28
Table 8. Tables and queries used in calculating NO ₂ concentrations.	29
Table 9. Formulas used in calculating the NO ₂ concentrations.	29
Table 10. Tables and queries used in calculating PM _{2.5} concentrations.	30
Table 11. Formulas used in calculating the PM _{2.5} concentrations.	31
Table 12. Tables and queries used in calculating CO concentrations.	32
Table 13. Formulas used in calculating the CO concentrations.	32
Table 14. Tables and queries used in calculating BS concentrations.	33
Table 15. Formulas used in calculating the BS concentrations.	34
Table 16. Tables and queries used in calculating EAS concentrations.	35
Table 17. Formulas used in calculating the EAS concentrations.	35
Table 18. Tables and queries used in calculating the Fixedruns parameters.	36

APPENDIXES

- I** *EXPOLIS* Data Specifications for Questionnaire Data. Otto Hänninen, 34 pages.
- II** *EXPOLIS* Dataentry. Otto Hänninen, 50 pages.
- III** How to Calculate VOC Concentrations from the *EXPOLIS* Database. Otto Hänninen, Sari Alm, Jouni Jurvelin and Esa Kaarakainen, 22 pages
- IV** How to Calculate NO₂ Concentrations from the *EXPOLIS* Database. Otto Hänninen and Kirsi Kumpulainen, 16 pages.
- V** Calculating PM_{2.5} Concentrations from the *EXPOLIS* Database. Otto Hänninen, Sari Alm, Kimmo Koistinen and Esa Kaarakainen, 40 pages.
- VI** *EXPOLIS* Local CO Database, User's Instructions for Updating to Version 9811 (with instruction sheets appended). Otto Hänninen and Esa Kaarakainen, 26 pages.
- VII** *EXPOLIS* Local CO Database, User's Manual. Otto Hänninen and Esa Kaarakainen, 50 pages.
- VIII** Calculating Ambient Averages with the *EXPOLIS* Ambient Database. Otto Hänninen, Juha Keski-Karhu and Esa Kaarakainen, 30 pages.
- IX** Black Smoke in *EXPOLIS* Database. Sari Alm, Jutta Salo and Esa Kaarakainen, 12 pages.
- X** How to Calculate EAS Concentrations from the *EXPOLIS* Database. Sari Alm, Esa Kaarakainen and Otto Hänninen, 10 pages.
- XI** Creating Final *EXPOLIS* Database. Esa Kaarakainen, 28 pages.
- XII** *EXPOLIS* CIDB: Combined International Database. Sari Alm, Esa Kaarakainen and Otto Hänninen, 52 pages.

Foreword

The purpose of this document is to collect all the material written during and after the original *EXPOLIS* study to document the data system. Emphasis is on the parts that are relevant for the users of the *Combined International EXPOLIS Database (CIDB)*. The original documents are included as appendixes.

This document is targeted for the users of the **CIDB**, but it might be helpful also for users of the *EXPOLIS* databases in other studies and for data managers in their planning data management for new studies. The user of *EXPOLIS* data and the databases described in this document should be familiar with the study design features like population sampling and measurement protocols.

The databases described were developed in KTL. During the pilot and fieldwork the input from researchers in all centers was most important. All the persons who participated this work, listed on the next page in the acknowledgements, deserve our gratitude.

On behalf of the authors

Kuopio, October 4th, 2002

Otto Hänninen

Acknowledgements

EXPOLIS Team Members

The *EXPOLIS* cities and team members in alphabetical order, principal investigators in bold:

- University of Athens, Medical School, Mikras Asias 75, GR-11527 Athens (Goudi), Greece
*Maria Caparis, Lambros Georgoulis, **Klea Katsouyanni**, Nikos Manalis, Evi Samoli, Yannis Tountas, Panagiotis Vouros*
- University of Basel, Institute of Social and Preventive Medicine, Steinengraben 49, CH-4051 Basel, Switzerland
*Ursula Ackermann-Liebrich, Tobias Braun, Katja Bürer, Tilman Eberle, Dominik Heeb, Tanja Hummel, Pius Krütli, **Nino Künzli**, Lucy Oglesby, Renata Sandroni, Kurt Schläpfer, Dieter Schwickert, Thomas Szegvary*
- Federal Institute of Technology (ETHZ), Department of Hygiene and Applied Physiology, Clausiusstrasse 25, CH-8092 Zürich, Switzerland
Christian Monn
- Carbotech AG, Eulerstrasse 68, CH-4051 Basel, Switzerland,
Barbara Roth, Kurt Schläpfer
- University Joseph Fourier, Medical School Institute of Grenoble, Domaine de la Merci, F-38706 La Tronche, France
*Celine Boudet, Franck Balducci, Jacques Dechenaux, **Denis Zmirou***
- KTL, Department of Environmental Hygiene, P.O.Box 95, FIN-70701 Kuopio, Finland
*Sari Alm, Tirre Halonen, Otto Hänninen, **Matti Jantunen**, Jouni Jurvelin, Esa Kaarakainen, Juha Keski-Karhu, Kimmo Koistinen, Anu Kousa, Anna-Maija Piippo, Tuula Pipinen, Tuulia Rotko, Tuija Stambej, Virpi Tenhola*
- VTT, Technical Research Centre of Finland, Chemical Technology, P.O.Box 1403, FIN-02044 VTT, Finland
*Jutta Laine-Ylijoki, Kirsi Manninen, **Kristina Saarela**, Markus Tähtinen*
- University of Milan, Institute of Occupational Health, Via San Barnaba 8, IT-20122 Milan, Italy
*Daniela Alcini, Donatella Bollini, Sabrina Braiati, Paolo Carrer, Domenico Cavallo, Rossana Ghalandar, Lauretta Lovato, **Marco Maroni**, Giovanna Radaelli, Franco Vercelli, Franco Visigalli*
- Imperial College of Science, Technology and Medicine, Department of Environmental Science and Technology, Prince Consort Rd., London SW7 2BP, United Kingdom
*Mike Ashmore, Paul Cullinan, Helen Ferrier, Michaela Kendall, Isabella Lindup, Madeleine McMullen, **Mark J Nieuwenhuijsen**, Edward Wigzell*
- Reg. Institute of Hygiene of Central Bohemia, Lab. of Genetic Ecotoxicology, Dittrichova 17, CZ-128 06 Prague 2, Czech Republic
*Libuse Polanská, **Radim Srám**, Eva Tischerova*
- EC JRC, Institute of the Environment, TP 290, IT-21020 Ispra, Italy
*Maurizio De Bortoli, **Helmut Knöppel***
- RIVM, Department of Chronic Diseases and Environmental Epidemiology, P.O.Box 1, NL-3720 BA Bilthoven, The Netherlands
*Oscar Breugelmans, Hanneke Kruize, **Erik Lebret***

EXPOLIS Funders

This work has been supported by EU Contracts ENV4-CT96-0202 (DG12–DTEE) and ERBIC20CT96-0061, Academy of Finland N36586, KTL projects 2169, 2127; Bundesamt für Bildung und Wissenschaft BBW Nr. 95.0894; Schweizerischer Nationalfonds 32-048922.96; French Department of Environment (96096), French National Environment Agency (ADEME 9693035), Routière de France and Grenoble Communauté de Communes; UK DETR Contract no: EPG 1/5/106, Dept of Health and Wellcome Trust.

1. INTRODUCTION

Air pollution epidemiology studies of the past 10-15 years have radically changed our understanding of the health effects of air pollutants. 15 years ago most experts would have agreed, that events, such as the London 1952 air pollution episode, which killed thousands of people within days are far in the past, and severe health effects of the present air pollution levels in North America and Western Europe should be rare. We now estimate that annually tens of thousands of cases of respiratory and cardiovascular mortality and significant reduction in the length of life in Europe are linked to air pollution, especially fine PM.

All the above mentioned studies are based on ambient air data from urban air quality monitoring networks. The harmful health effects of urban air pollutants are not, however, caused by the levels at those fixed monitoring sites, but by personal exposures of millions of individuals in their daily activities in mostly indoor environments and in commuting between them.

Numerous air pollution exposure studies have been done, but still few on representative population samples. Before *EXPOLIS* most of European exposure data were collected from non-representative and often small numbers of subjects. Clearly missing were representative and comparable air pollution exposure data, which could be used to assess air pollution exposure distributions in populations, to search for the factors for high exposures or to evaluate exposure distributions within specific sub-populations.

The present document describes in full detail the *EXPOLIS* Access database, which contains all of the measured and questionnaire data collected during the years of 1996 – 98 in the seven participating *EXPOLIS* cities. These Introductory chapters describe in short the *EXPOLIS* study purpose, rationale and design. For more detailed information about the study background, design and methodologies the reader is referred to Jantunen et al. 1998 and 1999. *EXPOLIS* results have been already published in more than 40 original articles and numerous academic dissertations across Europe. Yet, we believe that most of the new knowledge and benefits, which can be derived from this huge database, lie still ahead. To make them possible, we want to make this database available for researchers and professionals outside of the original *EXPOLIS* teams. Therefore we have published this comprehensive document and the CD-ROM containing all original and combined data.

1.1. Scope and Objectives of *EXPOLIS*

EXPOLIS (Air Pollution Exposure Distributions within Adult Urban Populations in Europe) -study focuses on working age urban populations in Europe, exposed to air pollutants in their homes, workplaces and other common urban microenvironments (streets, shopping, etc), and commuting between them.

For selected urban air pollutants *EXPOLIS* directly determines:

- exposure distributions for target populations
 - concentration distributions for the most important microenvironments
 - time activity distributions of the target populations
 - The *EXPOLIS* data is stored in this international database for further analyses. With this database, using statistical methods, the following can be analyzed:
 - statistical associations and logical links between exposures to different air pollutants
-

- the contributions of different air pollution sources to air pollution exposures
- the relationships of geographic, housing, occupation and commuting related, behavioral and socio-economic factors to air pollution exposures
- Using *EXPOLIS* database, a probabilistic simulation model has been developed to assess the population exposure distributions
- for specific sub-populations
- for specific urban areas and
- for selected future scenarios

1.2. The *EXPOLIS* Cities

Exposures and microenvironment concentrations of selected air pollutants, PM_{2.5}, CO and 30 VOC compounds, were measured in seven European cities: Athens, Basle, Grenoble, Helsinki, Milan, Oxford and Prague. These cities were selected to represent different European regions, climates, city sizes and populations. Selection was also dictated by the presence of a research facility capable and willing to carry out this study protocol: University of Athens, Medical School; University of Basel, Institute of Social and Preventive Medicine; University Joseph Fourier, Medical School in Grenoble; KTL Department of Environmental Health (Kuopio, Helsinki); University of Milan, Institute of Occupational Health; Imperial College of Science, Technology and Medicine (London, Oxford); and Institute of Hygiene of Central Bohemia (Prague).

1.3. Air Pollutants

In each centre, the personal exposures and personal microenvironment concentrations were measured for PM_{2.5}, CO and 30 VOC compounds. The major air pollutants common to all cities were selected based on their health effects and their environmental concerns as follows:

- CO to represent exposure to traffic exhausts and indoor combustion sources,
- VOCs (see Table 3) because of health and welfare concerns both indoors and outdoors (carcinogenic, odorous and irritating compounds, precursors for tropospheric O₃), because many VOCs are useful source markers, and because the presently available data is of very heterogeneous quality, and
- PM_{2.5} because inhalable particles are presently the air pollutants of greatest health concern and interest, and because no PM_{2.5} exposure studies on representative population samples have been reported so far.

To facilitate the analysis of PM_{2.5} composition and source attribution, its black smoke (BS) levels were determined optically and elemental composition by energy dispersive XRF. In addition, NO₂ by 48-h samplers was collected from Basle, Helsinki, Oxford and Prague.

1.4. Microenvironments and Activities

Microenvironment is a location where, for the purpose of an application, air pollutant concentrations at any given time can be considered homogenous. For simulation of population exposure distributions, all individual microenvironments that fall into the same category are grouped and processed as one microenvironment, and the concentrations measured or modeled for this microenvironment are presented in the form of a frequency

distribution. In air pollution exposure modeling and simulation, concentration information from the microenvironments contributing significantly to the population exposure are needed. The microenvironments selected for *EXPOLIS* were home indoors, home outdoors, workplace indoors, workplace outdoors, traffic (with subcategories), and other outdoor and other indoor.

Work environments differ more than home environments from the viewpoint of exposure to air pollution. Public services, shops, offices, transportation, institutional and industrial work all have different characteristics. Heavy occupational exposures are excluded from the analysis, because they are too uncommon to be adequately represented in our population samples.

1.5. Population Samples

Target populations of this study are the adult, urban populations of Europe. *EXPOLIS* focuses on 25...55 year old individuals, because they represent the most heterogeneous, active and mobile fraction of the population, and their exposures are presumably most affected by urban traffic planning, zoning and occupational conditions. A WHO Guide estimates that a probability sample of a minimum of 50 subjects is needed for the sample to represent any target population. Larger samples are needed if the target population is divided into sub-populations for quantitative estimation of how the exposures relate to e.g.; home location, indoor sources, commuting, work, and socioeconomic parameters.

Too small sub-samples produce poor estimates of exposure frequency distributions in the respective sub-populations. On the other hand, ensuring that all interesting sub-populations would have at least 50 representatives in our probability samples in each of the seven *EXPOLIS* cities would have resulted in a prohibitively expensive study.

While personal exposure and microenvironment sampling/monitoring is laborious, questionnaire and time-microenvironment-activity-diary (TMAD) application is much simpler. These two methods for acquiring personal exposure information were combined by sample pooling; drawing one sub-sample for exposure and microenvironment monitoring plus TMAD and questionnaire application (Exposure sample for short), and another sub-sample for TMAD and questionnaire application without exposure or microenvironment monitoring (Diary sample for short).

EXPOLIS includes a large Exposure sample in only one city (Helsinki) whereas the other centers had a smaller Exposure sample to participate in the full assessment, and a larger Diary sample to contribute time-microenvironment-activity-diary and questionnaire data only. Thus in one center, Helsinki the Exposure sample consisted of 201 randomly selected subjects, sufficient for estimating both population exposure distributions and exposure differences between different sub-populations as well as the relative roles of different determinants of exposure. In the other centers one can estimate population exposure levels and distributions for comparison between the centers and combined analysis of pooled data. The Exposure-samples consisted of 50 subjects in the other centers. In addition samples of another 50 - 250 subjects, depending on the sampling logistics in each center, formed the Diary samples.

In Helsinki a primary sample of the target population was formed by a random draw of 2523 adults (25 - 55 years of age) of the Helsinki Metropolitan Area from the population census. A short questionnaire about home environment, occupation, socioeconomic status,

commuting, some personal characteristics and willingness to participate in the study was mailed to this primary population sample. A response rate of 75% was aimed at, and 1881 subjects did return the filled short questionnaire. The final Exposure and Diary sub-samples were drawn at random from the primary sample subjects, who had answered the short questionnaire, after having excluded the clearly unwilling or unqualified (e.g. work outside of the area) individuals. Similar procedures were applied in other *EXPOLIS* centers. In Athens, Basle, Milan, Oxford and Prague the primary samples were based on a random draw from the city inhabitants. In Milan and Prague the Exposure and Diary samples were drawn from the municipality employees. In Grenoble an ongoing study on the PM_{2.5} exposures and daily symptoms of 40 volunteering asthmatics, 20...60 years of age, was adapted to yield PM_{2.5} exposure results which can be related to the data from other *EXPOLIS* centers.

A data integrity protocol was established according to the data security requirements of EU Directive on Protection of Individuals with Regard to Processing Personal Data in Medical and Epidemiological Research. This protocol includes the contents and security of the *EXPOLIS* databases, using of person numbers, which cannot be translated back to identity, and training for the whole staff.

1.6. Measurement scheme

The personal exposure and microenvironment concentration data were collected from the Exposure subjects during one year from fall of 1996 to winter of 1997-98. Each subject carried a personal exposure monitoring case, and her/his home, inside and outside, and workplace were equipped with microenvironment measuring equipment for a period of 48 h. The workplace concentrations were measured for the normal working hours at the actual workplace of the subject, or if the subject moved between locations during work, at one typical work location. The home inside and outside concentrations were monitored from the time when the subject would normally return from work to the time when she/he would normally leave home for work. The measurements were made during the workweeks, mostly from Monday morning to Wednesday morning, and Wednesday evening to Friday evening. The Diary subjects' data collection covers the same periods.

1.6.1. Personal and microenvironment measurements

The personal exposure monitoring equipment, PEM, (4 Lpm sampling pump, 2.5 µm cyclone, and 37-mm holders with filters, VOC sampling tube, CO-monitor, and a battery pack) was packed into an aluminum briefcase carried by each subject for 48 h. Two filter holders filters were provided for each subject; one '*day filter*' for two sampling periods beginning at leaving home for work and ending at return home from work, and one '*night filter*' for the remaining times.

VOCs were sampled into Tenax-TA containing tubes by vacuum of the same pump that sampled the PM_{2.5}. The target sample size was 2...3 L. In Basel the VOCs were collected using Carbotrap tubes. The target sample size was 10 times higher than with Tenax.

The CO-PEM was based on electrochemical detection. The unit records the CO concentration (0.1 - 12.8 ppm, and 1 - 128 ppm ranges) as well as internal and external temperature. 1-minute interval was used in *EXPOLIS* measurements.

Workplace and home indoor and outdoor microenvironment monitors (MEM) (16.7 Lpm sampling pump, 2.5 µm impactor, 47-mm filter holder with filters and a VOC tube packed into a portable sound absorbing container) were programmed to run inside and outside of the home for the expected non-working hours and in the workplace for the expected working hours of each subject.

1.6.2. Questionnaires and Time-activity monitoring

EXPOLIS used four questionnaire based measurement tools:

- 1) Short Screening Questionnaire,
- 2) Core Questionnaire,
- 3) Time-Microenvironment-Activity-Diary (TMAD), and
- 4) Retrospective Exposure Questionnaire.

The purpose of Short Screening Questionnaire was to evaluate the subjects' intention for participation.

Core Questionnaire covered the indoor air quality related characteristics of each subject's home and workplace, as well as commuting, socioeconomic and some exposure related personal characteristics, such as smoking.

The TMAD was used to assess the times that the subjects spend in each microenvironment and activity while their personal exposures and microenvironment concentrations were measured. The subject was asked to mark each 15-min of the day at the appropriate microenvironment and activity category. The microenvironment categories in this TMAD were in transfer (walk/bike, motor cycle, car/taxi, bus/tram, and metro/train) and not in transfer (home in and out, work in and out, other in and out), and activities cooking, smoking self and smoking in same room. Multiple entries (e.g. home indoor, home outdoor, car) were allowed for each 15 min.

Retrospective Exposure Questionnaire was filled at the end of the 48-hour PEM/MEM measurement period of each subject. It addressed specific activities which may influence personal exposure, particularly to VOC (cleaning, gluing, etc.).

1.7. *EXPOLIS* databases

A common relational database structure (*EXPOLIS* Access DataBase, EADB) was developed using Microsoft Access 7.0 to contain all *EXPOLIS* data from local Civil Register or other local registers, *EXPOLIS* TMAD:s, questionnaires, monitors, laboratory analyses, calibration procedures and environmental conditions as well as urban air quality network and meteorological data covering the field study periods. All data was stored in its primary form, if possible by direct downloading from pumps, microbalances and monitors, and all physical and statistical calculations were performed on the primary data in this database.

Data stored in the databases include:

- a. Exposure related questionnaire data, including 48-hour time activity diaries
- b. Personal exposure measurements of
 - PM_{2.5},**
 - 30 target **VOC** compounds,
 - CO,**
 - NO₂,**
 - BS,**
 - 37 elements in PM_{2.5}**
- c. Microenvironment concentrations (same compounds excluding **CO**)
 - home indoors,
 - home outdoors,
 - workplace
- d. Fixed station measurements of air quality and meteorology
 - all available/selected observations from each city

1.8. Quality Assurance

The general performance criteria of the quality assurance program in *EXPOLIS* were to minimize any differences between the centers which would affect the comparability of the results, and specifically to ensure quantified data for all PM_{2.5}, CO and NO₂ exposures and microenvironment concentrations.

The first performance criteria were pursued by using identical sampling equipment, questionnaires, time-activity diaries and work procedures in all centers, by training the junior researchers together in common workshops and by encouraging daily communication between them between the workshops.

The QA was based on the principles that (i) all procedures must be carefully planned, tested and performed according to standard operating procedures (SOP) approved by the study director, (ii) each unit of data must be traceable as to who produced it, when, with what equipment and according to which SOP(s), and (iii) if any deviations or irregularities occur they must be recorded. SOPs were tested in the pilot, corrected until they were approved by study coordinator and KTL QA Unit. The approved SOPs, as well as any modifications thereof, were distributed to all *EXPOLIS* centers and filed by the coordinator.

Additional reading for *EXPOLIS* Design:

Jantunen MJ, Hänninen O, Katsouyanni K, Knöppel H, Künzli N, Lebret E, Maroni M, Saarela K, Srám R, Zmirou D (1998) **Air pollution exposure in European cities: the EXPOLIS-study.** *J Exposure Anal Environ Epidemiol*, 8(4): 495-518.

Jantunen MJ, Katsouyanni K, Knöppel H, Künzli N, Lebret E, Maroni M, Saarela K, Srám R, Zmirou D: **Final Report: Air Pollution Exposure in European Cities: the EXPOLIS Study.** *Kansanterveyslaitoksen julkaisu* B16/1999. 127 pp., 4 Annexes.

2. DATA MANAGEMENT

2.1. Data Management Goals

Collecting and storing data is an essential part of any scientific study. In an international population based study, in which complex physical measurements are carried out together with large questionnaires, the role of systematic data management is important. The following goals were set for the data management in the *EXPOLIS* study:

1. All data needed for the analyses is entered in the database

Only recorded and stored data will be later available for the statistical analysis. Environmental and health related connections are complicated and hard to analyze with data sets not containing all affecting variables.

The need to measure and record different parameters must be carefully considered, and all necessary data must be included in the database structure

2. Data from the different centers are available and comparable

The measured parameters from the different centers must be defined in the same way and stored in the same format.

3. The database structure is flexible

All analyses that will later be done are not fully defined yet. Thus the database should be able to provide data in different formats and in different combinations.

The database should also provide tools for the field procedure management, like allocating of the equipment and sampling media.

4. The correctness of the data is maximized

Errors in the data will affect the strength of statistical analysis. As many of the relationships between the exposures and other parameters are weak, the number of data entry/storage/retrieval errors must be minimized.

Checking procedures must be provided.

5. The data entry is feasible

After the higher priority goals are taken into account, also the daily data entry tasks should be made as easy as possible.

6. Privacy of the customers is protected

The personal data must be removed from the other data as soon as it is possible without risking the quality of the other data.

2.2. Structure of the EXPOLIS Databases CD-ROM

The *EXPOLIS* Databases consist of the Combined International Database (CIDB) and complete copies of the Local databases from the *EXPOLIS* cities (Figure 1). CIDB contains the main results in a table format. All original detailed observations, used to calculate e.g. the pollutant concentrations from *EXPOLIS* measurements, can be found from the Local databases.

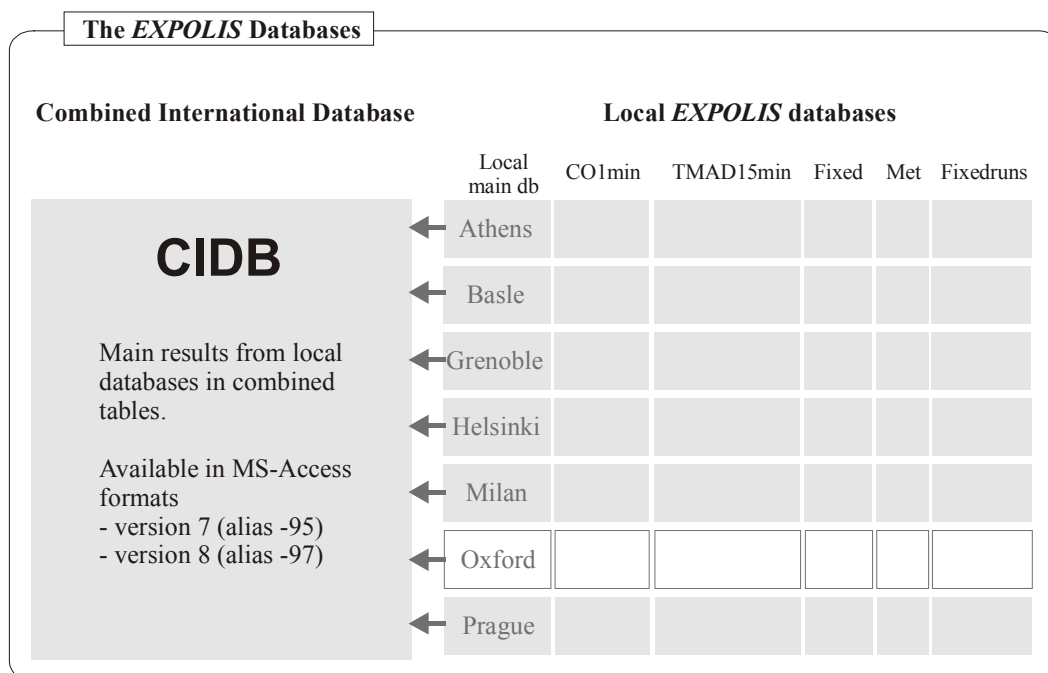

Figure 1. The Combined International Database consists of a subset of data from the Local databases in each city.

In each city the data is collected from various sources. Besides the actual measurements carried out in the *EXPOLIS* study, these include for example the local civil register, local meteorological observations and air quality measurements carried out by the local city authority (Figure 2).

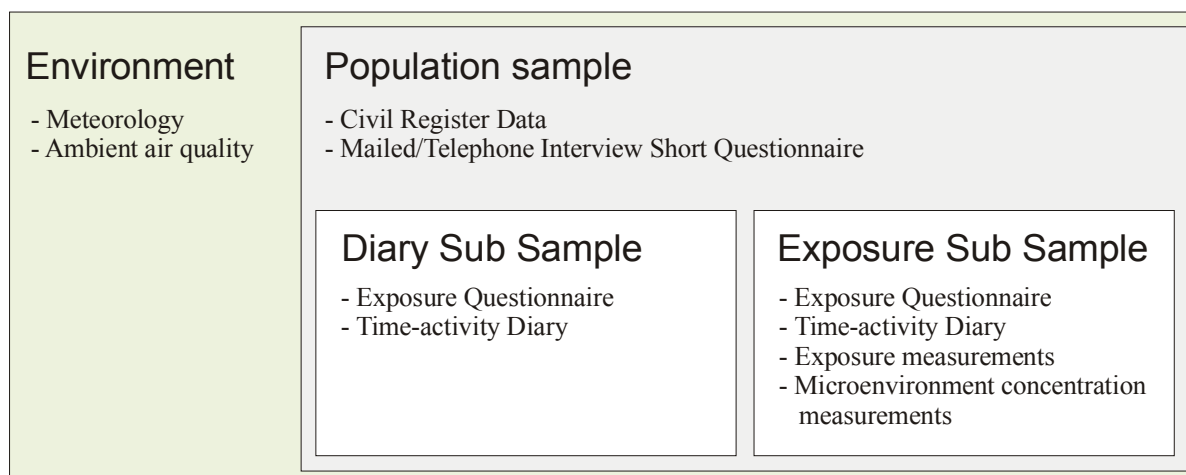

Figure 2. Data from each city contains information from different sources.

3. POPULATIONS AND SAMPLES

Urban adult populations were sampled in each city. The study subjects are identified in the database using customer identification code (**cid**, a long integer number). **Cid** number ranges for each city are listed in Table 1 together with the number of subjects for which data exists in the database. The Diary and Exposure samples are subsets of the base sample in most centers.

Table 1. Customer id (cid) ranges.

City	Start	End	Population samples		
			Base	Diary	Exposure
Helsinki	1	19.999	2099	234	201
Athens	20.000	29.999	1900	50	50
Basle	30.000	39.999	2668	282	50
Grenoble	40.000	49.999	5	7	99
Milan	50.000	59.999	514	250	50
Praque	60.000	69.999	58	33	50
Oxford	70.000	79.999	6	70	49

The Base Sample is a random population sample. Data concerning the Base Sample were collected from the Civil Register and using a short mailed questionnaire. Diary and Exposure Samples were randomly drawn from the Base Sample. The Diary Sample subjects answered the exposure-related questionnaires and filled a 48-hour time activity diary. The Exposure sample participated in the exposure and microenvironment measurements besides filling in the questionnaires and the time activity diary.

Notes about population samples and procedures used in the cities:

- In Athens the Exposure Sample was drawn from non-smoking subjects only.
- In Milan all study subjects for the exposure measurements were office workers.
- In Grenoble all study subjects for the exposure measurements were non-smoking volunteers, half of them were asthmatic patients and the other half control subjects. No microenvironment monitors (MEMs) were used; instead each subject carried two pumps; another one was used continuously while the other one was manually activated only when the subject was indoors.
- In Prague all study subjects lived in the central city area.
- In Oxford volumetric pumps with sampling rate of 4 Lpm were used as microenvironment monitors (MEMs) in indoor environments (home indoors and workplace). The 16.7 Lpm MEM pump was used only in home outdoor measurement.

Samples are identified in the database using long integer sample identification codes (**sid**). Six-digit sample identification code number space was divided into ranges for different sample types (Table 2). **NO₂** samples, which were added later, were given an overlapping number space with different criteria.

Each number range was subdivided into a number space for each city so that across the six original cities the sample numbers are unique. This is required in the CIDB, because some sample data are still identified by the **sid** code.

Table 2. Number ranges for sample identification codes.

Compound	sid range		sid criteria
	Start	End	
VOC (Tenax tubes)	100.000	299.999	Dividable by 99
NO ₂ (Palmes tubes)	100.000	999.999	Dividable by 93 but not by 99
PM _{2.5} + BS + elements (37 mm filters)	300.000	599.999	Dividable by 99
PM _{2.5} + BS + elements (47 mm filters)	600.000	999.999	Dividable by 99

In Oxford the sid codes followed the division rule ($\text{mod } 99$ or $\text{mod } 93 = 0$), but the original sid values were given from the same number space which had already been used by the original *EXPOLIS* centres. Thus to make the Oxford data combinable, the sid values were shifted to a new number space by adding 70.000.000 to them. This shift breaks the division rule.

4. THE DATABASES

All database files were originally created with Microsoft Access version 7 (alias 95). All Local databases are in this format. The Combined International Database (CIDB) was created in this format and a copy of it was then converted to Access 8 (alias 97) format.

The Local database consists of several database files. Some of these files contain data, others – the tool databases - contain forms, queries and other tools to work with the data and to link related data from different tables and from different database files together.

The CIDB is a single database file containing the questionnaire data (excluding detailed time activity data) and **VOC, NO₂, PM_{2.5}** and the running 1-hour and 8-hour maxima and 48-hour average **CO, BS and PM_{2.5} bound element** concentrations.

All the original observations, including the time activity diaries and 1-minute **CO** data, are stored in the Local databases. All these databases are stored together on the *EXPOLIS* Databases CD-ROM disk. The CD-ROM folders are shown in Figure 3.

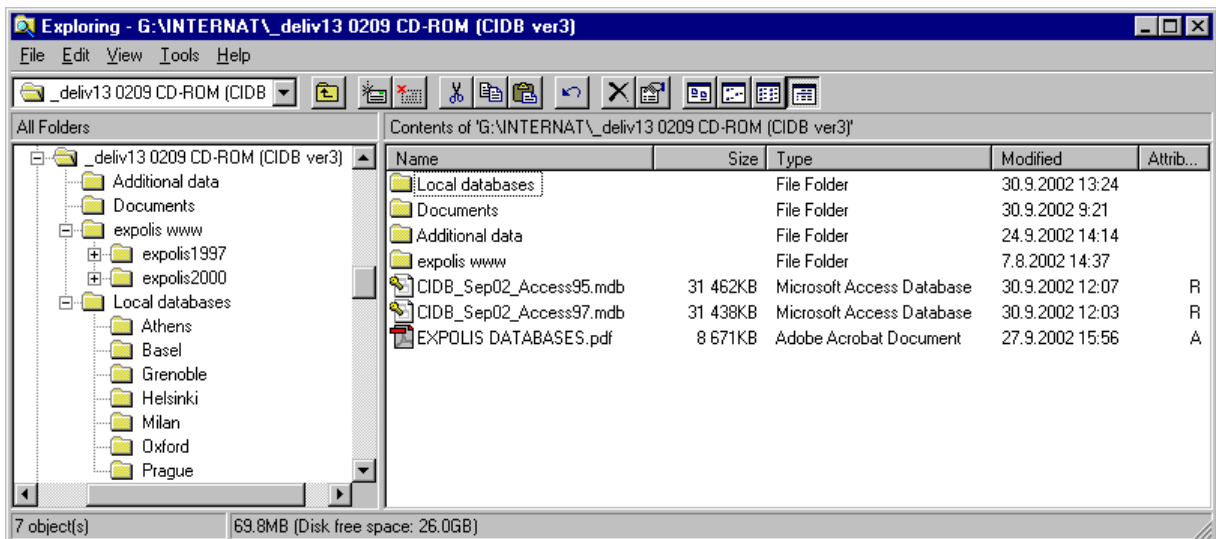

Figure 3. The *EXPOLIS* Databases CD-ROM contains the main CIDB database file (in Access 95 and Access 97 formats), project (www-pages) and database documentation and the detailed Local databases created in each center.

Table 3 below lists the local database files and demonstrates the required disk space by giving the file size in Helsinki.

Table 3. *EXPOLIS* database files (size of Helsinki file as of Dec 2001).

Local database files		
Data file	Tool file	Contents
HELSINKI.MDB (10MB)	EADBTOL.MDB (12 MB)	questionnaires, exposures, concentrations etc.
TMAD15min.MDB (20 MB)	TMAD15minTOOL.MDB (1.2 MB)	time-activity diaries, 15 minute avg. CO data
CO1min trash.MDB (36 MB) CO1min.MDB (33MB)	CO1minTOOL.MDB (1.2MB)	1 minute CO concentration data
FIXED.MDB (55 MB) MET.MDB (7MB) FIXEDRUNS.MDB (26 MB)	AmbientTOOL.MDB (1.8MB)	Hourly ambient air quality data 3-hourly meteorological data <i>EXPOLIS</i> sample sampling period averages of ambient and met data
Combined International database files		
CIDB_Dec_00_Access95.mdb (31 MB)	None	Combined database in Access 95 (version 7) format
CIDB_Dec_00_Access97.mdb (31 MB)	None	Combined database in Access 97 (version 8) format

4.1. Tool databases and linked tables

The *EXPOLIS* Databases were developed during the project field phase. Thus the analysis tools (e.g. concentration calculation query networks) were developed at the same time as the data was entered into the database.

To allow updates to the database tools without affecting the data files and to allow smallest possible size of the data files for data transfer between centers, the *EXPOLIS* Databases were designed so that the data and tools were kept in separate files. The tool files contain links to the tables in the data files. The tables contain the observations.

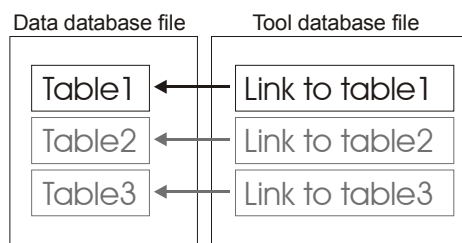

Figure 4. Data and tool database files.

To make the tool database files functional the linked tables must be updated to point into the correct location of the data file containing the data. Managing table links the Access add-on called Linked Table Manager must be installed. Installation of this standard add-on is explained in the Appendix 1 of the **Appendix VI**.

4.2. Security policies

Because the *EXPOLIS* Databases were installed in a network environment and during the field phase they contained sensitive personal information, including telephone numbers and addresses, a security policy was implemented.

Personal user accounts were created for the researchers working with the database. The user accounts are created in an Access workgroup file. The **wrkgadm.exe** application, provided with Access is used to join an installed Access program to a specified workgroup file.

User group *EXPOLIS User* was created with privileges to enter data. Members of this group do not have rights to modify the queries provided in the tool databases; they can, however, create new queries and edit them freely.

4.3. Queries and join types

As a typical relational database environment, data in MS-Access is processed using queries. These are Standard Query Language (SQL) queries, which can be designed, viewed and edited using the visual editing tools provided in Access environment.

Queries use 2-dimensional tables as inputs, perform calculations as specified by the query design and output 2-dimensional tables (Figure 5). Queries can be nested, i.e. the tables used as inputs in a query can be outputs of another query.

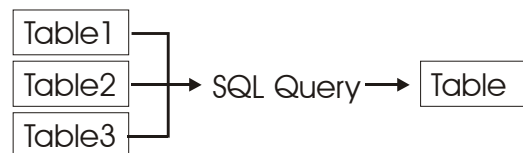

Figure 5. Queries combine data from tables, perform calculations and output new tables. Query outputs are dynamic – values are recalculated from source data when every the query is run.

The rows in different tables are connected to rows in queries by using *joins*. Two basic join types are supported as shown in Figure 6.

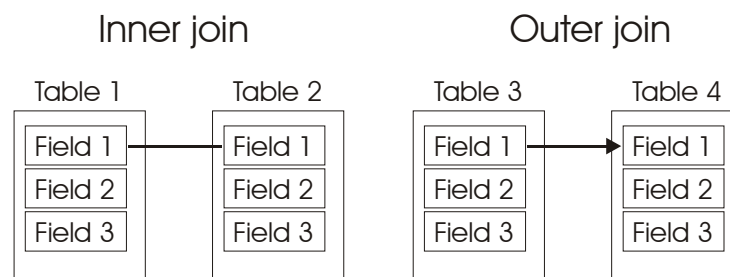

Figure 6. Inner join requires a record from both tables while outer join allows missing records in table 4 above.

4.4. Field-stage forms

During the field stage tasks like working with the population samples, contacting subjects and preparation of sampling media and equipment were managed using the local *EXPOLIS* database. The database was set up with user accounts to identify users, to set privileges and to allow protection against unwanted access to the database.

A set of forms and queries were prepared to allow efficient working and automatic data entry error checking. These field stage management and data entry tools are described in the corresponding document in the Annexes; because they are of limited use for the user of the final database, they will not be described in further detail here.

Forms were used to implement the data entry and data checking tools used during and after the field stage.

4.5. VBA Modules

Visual Basic for Applications (VBA) programming code is used widely within the query networks. Reasons to use VBA code instead of immediate formulas in queries include:

- Using same function in multiple queries
- Complex logic would lead to difficult to read immediate formulas
- Handling of missing values (-9)
- Performing calculations requiring multiple steps

Visual Basic code is placed in Modules in MS-Access. The following Table 4 lists the modules in the *EXPOLIS* databases and Table 7 the functions and procedures in these modules. Some of the modules are used in many of the databases and they have been copied from the database where they were developed to other ones. The fact that some code exists in multiple copies easily leads to having also multiple versions of the same code. User of the code is hereby warned about this.

VBA code of the most important functions is listed in the CQN documents in the Appendixes.

Table 4. *EXPOLIS* database files and the VBA modules contained within.

#	MODULE NAME	HELSINKI.MDB	EADBTOOL.MDB	TMAD15min.MDB	TMAD15minTOOL.MDB	CO1min.MDB	CO1minTOOL.MDB	FIXED.MDB	MET.MDB	FIXEDRUNS.MDB	AmbientTOOL.MDB	CIDB_DEC_00.MDB
1	CommutingTransformation	o										
2	CompareTables	o										
3	EADBbatches deliv2	o										
4	DBMmo Procs	1										
5	EADBADMIN	o										
6	EADBCopy	o										
7	EASModule	o										
8	Esa Test	o										
9	ExpolisCoords	o										
10	ExpolisModule1	o										
11	ExpolisNormalize	o										
12	ExpolisPMStd	o										
13	ExpolisSort	o										
14	ExpolisWeighingImport	o										
15	PM BS	o										
16	<i>StaUp procs</i>	A										
17	DBMo Procs		2									
18	DBMmo Procs			3								
19	EADBCopy			o								
20	Module1			o								
21	<i>StaUp procs</i>			B								
22	DBM Procs				4							
23	CO module					o						
24	CO TMAD calibration					o						
25	DBMmo Procs						5					
26	<i>StaUp procs</i>						C					
27	DBMmo Procs							6				
28	DBMmo Procs2							7				
29	difference centre module							o				
30	Difference module							o				
31	ExpolisCoords							o				
32	location centre module							o				
33	location module							o				
34	wind vector module							o				

o Module is in the database

A-C Multiple (identical) copies of StaUp module are shown with these symbols

1-7 Different versions of DB management modules are numbered.

Table 5. List of VBA functions and procedures contained in the *EXPOLIS* databases.

DATABASE	MODULE NAME	FUNCTIONS/PROCUDURES				
HELSINKI.MDB	CommutingTransformation	Public Function Sum5(v1, v2, v3, v4, v5) As Double Public Function Sum5(v1, v2, v3, v4, v5) As Double				
	CompareTables	Public Sub CompareTables()				
	EADBbatches deliv2	Public Function EmptyTable(TableName As String) Public Sub DisplayTables() Public Sub ClearTables()				
EADBT00L.MDB	DBMmo Procs	Public Sub DisplayQueries() Public Sub DisplayTables() Public Function EmptyTable(tbl) As Boolean Function EnumTables() As Integer Sub CheckError() Public Function GetObjInf(obj As String, InfType As String) As String Public Function dateToSqlDate(tdDate) Public Function CanDelete(tbl) As Boolean Public Function Affections(sCrit) As String				
		EADBADMIN	Public Function QryCount() Public Function DelQryDefs() Public Function DelTableDefs() Public Function CompareSQL(sourceQry As String, targetQry As String, targetdb As String) Public Function ComparePMQry2(targetdb As String) Public Sub ComparePMqry1() Public Function CompareFDBqry2(targetdb As String) Public Sub CompareFDBqry1() Public Sub CompareBSqry1() Public Function CompareBSqry2(targetdb As String)			
			EADBCopy	Public Function CpQryDefs(trgt As String) Public Function CpTableDefs(trgt As String) Public Function CpQry(qryName As String, trgt As String) As Boolean Public Sub cpPMqry1() Public Sub cpqry1() Public Sub cpFDBqry1() Public Function cpFDBqry2(targetdb As String) Public Function cpPMqry2(targetdb As String) Public Sub cpBSqry1() Public Function cpBSqry2(targetdb As String) Public Function cpqry2(targetdb As String) Public Function kopioiEAS2(targetdb As String) Public Sub kopioiEAS1()		
				EASModule	Public Function EASyjoint(spl) Public Function FdbEASSub(cType As String, env As String) As Recordset Sub ForceError() Public Function FdbEAS(cType As String, env As String) As Boolean Public Function getEIFlds(cType, env) As String Public Function EASToCIDB() Public Function queryExists(qryName As String) As Boolean	
					Esa Test	Public Function formatQdef(qname As String)
					ExpolisCoords	Public Function EucDist(Nst, Est, Ncust, Ecust) As Double
					ExpolisModule1	Public Function GetCurrentEnv() As String Public Function CheckSampleNr(nr As Long) As Boolean Public Function GetMyCustomer() Public Function SetCurrentEnv(env As String) As String Public Function GetId() Public Function SetID(nid As Variant) Public Sub OpenForm(Name As String, view As Integer) Public Sub AddLog(Action As String) Public Sub EndLog(Action As String) Public Function SetMyCustomer(id As Long) Public Sub GotoCustomer() Public Function SubSampleH(sel) As String

continued...

Table 5 (continued 2/3). List of VBA functions and procedures contained in the *EXPOLIS* databases.

DATABASE	MODULE NAME	FUNCTIONS/PROCUDURES
2/3; continued...		
EADBTOOL.MDB	ExpolisNormalize	Public Function AirDensity(p, t, rh) As Double Public Function BuoyancyFactor(a) As Double Public Function volff(t As Double, p As Double) ' [°C], [mmHg] Public Function NormalizedRatio(p1 As Double, p2 As Double) Public Function FlowAvg(pf, Ts As Double, Ps As Double, af, Te As Double, Pe As Double) Public Function FlowAvgUnf(pf As Variant, af As Variant) Public Function OkMax(i, j) As Integer Public Function OkMaxAbs(i, j) As Integer Public Function OkMax4(i, j, k, l) As Integer Public Function volume(flow, dur) As Single Public Function Concentration(mass, volume) As Single Public Function nomf(typ) ' OH 21.5.2002 version modified for Hak Kan Public Function ntpv(typ As String, t, mb, v) ' PEM volumetric sample conversion to NTP (Oxford/Hak Kan)
	ExpolisPMStd	Public Function custStat(cidTmad As Variant, cidExp As Variant) As String Public Function getVbest(pump As String, vntp As Variant, vf As Variant, unvol As Variant, vnom As Variant) As Double
	ExpolisSort	Public Function EnvSort(e) Public Function SpiSort(s) Public Function RunSort(e, s, d) Public Function yjoint(spl)
	ExpolisWeighingImport	Public Sub DisplayTables() Public Sub DisplayQueries() Public Function GetCnt(sid As Long) 'GetCnt (C) Otto Hänninen 7.5.1997 Public Function SetCnts() Public Function GetLastCnt(sid As Long) Function triplebeep()
	PM BS	Public Function IsLong(aStr As String) As Integer
	StaUp procs	Public Function GetLastRunInf(qry, InfType) Public Function InsertStatQryTbl(qry, rt, s, ed, lng) As Boolean Public Function RemoveAllUpDFields() Public Function RunUpdateQrys() As Boolean Public Function SelectAllUpDFields() Public Function SetUpdateField(trgtTbl) Public Function StaUpUpdate() Public Function UpdateStaticTables() As Boolean
TMAD15min.MDB	DBMo Procs	Public Sub DisplayQueries() Public Sub DisplayTables() Public Function EmptyTable(Tbl) Function EnumTandQ() As Integer Public Sub HiiteenKaikkiData()
TMAD15minTOOL.MDB	DBMmo Procs	***see EADBTOOL.MDB module with same name
	EADBCopy	Public Function CpQryDefs(trgt As String) Public Function CpTableDefs(trgt As String) Public Function CpQry(qryName As String, trgt As String) As Boolean Public Sub cpCOCQry1() Public Function cpCOCQry2(targetDb As String)
	Module1	Public Function EnvSums(cid, walk, moto, car, bus, train, hi, ho, wi, wo, oi, oo) Public Function IntDate(d As Date) Public Function xpt(walk, moto, car, bus, train, hi, ho, wi, wo, oi, oo) As Integer Public Function Env(walk, moto, car, bus, train, hi, ho, wi, wo, oi, oo) Public Function updateTMADEnvSums(cid, fld, val) As Boolean
	StaUp procs	***see EADBTOOL.MDB module with same name
CO1min.MDB	DBM Procs	***see TMAD15min.MDB module [DBMo Procs]

Table 5 (continued 3/3). List of VBA functions and procedures contained in the *EXPOLIS* databases.

DATABASE	MODULE NAME	FUNCTIONS/PROCEDURES
3/3; continued...		
CO1minTOOL.MDB	CO module	Public Function IssROk(COStart, COEnd, SRStart, SREnd) Public Function AddComment(COStart, COEnd, SRStart, SREnd) Public Function ErrorType(COStart, COEnd, SRStart, SREnd) Public Function SplGroup(spl) Public Function COconc_NotUsed(CO1, zmon, fmon) As Single Public Function FindPeaks() As Boolean Public Function CoTCor(CoM, zero, Temp) As Variant Public Function CoSRCoverage(dur, sdif, edif) As Double
	CO TMAD calibration	Public Function Env(walk, moto, car, bus, train, hi, ho, wi, wo, oi, oo) Public Function mEnv(walk, moto, car, bus, train, hi, ho, wi, wo, oi, oo, ac, asm, ar) As Integer Public Function nOfEnvs(walk, moto, car, bus, train, hi, ho, wi, wo, oi, oo) As Integer Public Function IsOutdoors(Env) As Boolean Public Function IsIndoors(Env) As Boolean Public Function IsTraffic(Env) As Boolean
	DBMmo Procs	***see EADBTOL.MDB module with same name
	StaUp procs	***see EADBTOL.MDB module with same name
FIXED.MDB	<i>(no modules)</i>	
MET.MDB	<i>(no modules)</i>	
FIXEDRUNS.MDB	<i>(no modules)</i>	
AmbientTOOL.MDB	DBMmo Procs	***see EADBTOL.MDB module with same name NOTE: changes '+' added, '-' non included: +Public Function UpdateStaticTables() +Public Function SetUpdateField(trgTbI) +Public Function RunUpdateQrys() As Boolean +Public Function InsertStatQryTbI(qry, rt, s, ed, lng) As Boolean +Public Function GetLastRunInf(qry, InfType) +Public Function SelectAllUpDFields() +Public Function RemoveAllUpDFields() +Public Function StaUpUpdate() -Public Function dateToSqlDate(tDate) -Public Function CanDelete(tbI) As Boolean -Public Function Affections(sCrit) As String
	DBMmo Procs2	***see EADBTOL.MDB module with name [DBMmo Procs]
	difference centre module	Public Function diffc(WindV, slopec)
	Difference module	Public Function diff(P48WindV, slope)
	ExpolisCoords	Public Function EucDist(Nst, Est, Ncust, Ecust) As Double Public Function Coverage(n, dur)
	location centre module	Public Function slopec(Ehome, Nhome)
	location module	Public Function slope(Ehome, Nhome)
	wind vector module	Public Function angle(x, y)
CIDB_DEC_00.MDB	<i>(no modules)</i>	

5. CONCENTRATION QUERY NETWORKS

The CIDB files contain only tables with readily calculated values, e.g. for concentration variables. The Local databases, however, calculate the concentrations dynamically from the original observations. The CIDB user does not need to understand the details of these queries, but a user of the Local databases should at least understand the main principles of these queries.

Concentration calculations for **PM_{2.5}**, 30 target **VOCs**, **NO₂**, **CO**, **BS** and **PM_{2.5} bound elements** all depend on several observations. **PM_{2.5}**, **VOC**, **BS** and **element** sampling were based on active airflow through a sampling media (Teflon filter and Tenax absorbent). Airflow was measured and the sampled air volume is calculated in the CQN by taking into account variables like flow calibration measurements, atmospheric pressure, temperature and sampling duration (calculated as difference between start and end times).

CO and **NO₂** measurement was based on passive sampling – i.e. free air currents and diffusion. **CO** monitor included a electrochemical sensor and a miniature computer for data logging. The sensor is slightly temperature-sensitive, and thus besides the calibrations with zero and standard gases the **CO** data were corrected according to the sensor temperature data. The **NO₂** samples were analyzed using a photometer and concentrations were calculated from the observed absorbancies.

Data entry tools were used to enter the measurements and calibrations into the database. Each observed value was stored exactly once and all values depending on the original observations were dynamically calculated from these by the query networks.

The following sections summarize the CQNs by listing queries forming them. The formulas used within the queries are also shown. It must be noted that this summary is not complete by itself. The details are described in the original documents for each CQN. These documents can be found in the Appendixes.

5.1. VOC concentration calculation

The concentrations are calculated using values from the tables and the queries listed in Table 6.

Table 6. Tables and queries used in calculating VOC concentrations.

TABLES	QUERIES		
	Mass calculation	Volume calculation	Concentration
ESamples	VOC lod mass	Dur	VOC lod c
ERuns		VOC Flows	VOC lod c I
EFlows		VOC Volumes	VOC lod c O
EEquipment			VOC lod c W
ESetupDates			VOC lod c P
ECondSetup			
VOC shipments			
VOC tubes			
VOC masses			
VOC compounds			
VOC detection limit			

The formulas used in the VOC concentration calculations are shown in Table 7.

Table 7. Formulas used in calculating the VOC concentrations.

Query	Formula
VOC lod mass	$m_lod: IIf([m] > [lod], [m], ([lod]/2))$
Dur	$dur: Sum(24 * ([End] - [Start]))$
VOC Flows	$f: FlowAvg([Vpf], [Ts], [Ps], [Vaf], [Te], [Pe])$
VOC Volumes	$V: [f] * [dur] * 60 / 1000$
VOC lod c	$c: [m_lod] / [V]$

5.2. *NO₂ concentration calculation*

The concentrations are calculated using values from the tables and the queries listed in Table 8.

Table 8. Tables and queries used in calculating NO₂ concentrations.

TABLES	QUERIES
ESamples	Dur
ERuns	NO2 LabBlnkAvg NO2 c
NO2 shipments	
NO2 tubes	NO2 c I
NO2 results	NO2 c O NO2 c W NO2 c P NO2 c IOPW

The formulas used in the concentration calculations are shown in Table 9.

Table 9. Formulas used in calculating the NO₂ concentrations.

Query	Formula
Dur	<code>dur: Sum(24*([End] - [Start]))</code>
NO2 LabBlnkAvg	<code>group by batch; LabBlnk: average of abs; where blnk=1</code>
NO2 c	<code>Absnet: [abs] - [LabBlnk]; c: ([Absnet] * 43370.9 - 73.74) / [dur]</code>

5.3. *PM_{2.5} concentration calculation*

The concentrations are calculated using the tables and the queries listed in Table 10.

The queries and formulas listed in the table are taken from the EADBTOOL.mdb version May 2002, which was edited to accommodate the fact that Oxford used volumetric PEM pumps also in indoor microenvironments.

Changes that were made to the **PM_{2.5}** CQN are described in **Appendix V**, chapter Oxford modifications. The modified query network should run ok in all centers, when the indicated localization edits are done.

Table 10. Tables and queries used in calculating PM_{2.5} concentrations.

TABLES	QUERIES		
	Mass calculation	Volume calculation	Concentration
ESamples	PM m0	Dur	PM c std
ERuns	WRConditions	PM Flows	PM c
EFlows	PM m1	PM Volumes	
EEquipment	PM m2	PM Volumes std sub	
ESetupDates	PM m4	ECo t	
ECondSetup	PM m2 SumOfPEMs	PM Volumes SumOfPEMs	PM c2 P48
PM Filter samples	PM m4 SumOfMEM	PM Volumes SumOfMEM	PM c4 MEM
PM Weighing conditions			PM c P1
Fixedruns			PM c P2
CO15min			PM c O
			PM c I
			PM c W
			PM c P1P2P48IOW

The formulas used in the concentration calculations are shown in Table 11.

Table 11. Formulas used in calculating the PM_{2.5} concentrations.

Query	Formula
PM m0	ms0: ms; me0: me
WRConditions	group by date: Int([Sdate]) P, T and rh as daily averages a: AirDensity([P], [T], [rh]) f: BuoyancyFactor([a])
PM m1	m1: [WRC..._1] . [f] * [me0] - [WRC...] . [f] * [ms0]
PM m2	blank: IIf([env]="P", 0.0019, 0.0062) m2: [m1] - [blank]
PM m4	group by spl: yjoint([ESamples].[spl]) m4: sum of m2
Dur	dur: Sum(24*([End] - [Start]))
PM Flows	fn: FlowAvg([pf], [Ts], [Ps], [af], [Te], [Pe]) nomf: nomf([pump]) unf: FlowAvgUnf([pf], [af])
PM Volumes std sub ECot	p as average of avg where <u>site=hkiva</u> and <u>comp=pres</u> AvgTemp: as average of TAvG
PM Volumes	Vnom: Volume([nomf], [dur]) Vf: Volume([fn], [dur]) vnTP: nTPV([pump], [avgtemp], [p], Volume([unf], [dur])) unVol: volume([unf], [dur]) vbest: getvbest([pump], [vnTP], [vf], [unVol], [vnom])
PM c std	c_vnTP: IIf(Left([pump], 1)="B", Concentration([m4], [vnTP]), Concentration([m4], [vf])) c_unVol: IIf(Left([pump], 1)="B", Concentration([m4], [unVol]), -9) c_Vnom: Concentration([m4], [Vnom])
PM c	c: IIf([c_vnTP] <> -9, [c_vnTP], IIf([c_unVol] <> -9, [c_unVol], [c_vnom]))

Note: points requiring localization edits are underlined!

5.4. CO concentration calculation

The concentrations are calculated using values from the tables and the queries listed in Table 12.

Because of the large amount of data collected in the CO measurements the concentration calculation query network for CO is based on several static tables. In these tables values are calculated from the original CO measurements and calibration measurements by using append queries. Because of these values are stored in tables, instead of dynamic calculation by queries, the values in the tables do not automatically reflect changes made to the original observed values.

Table 12. Tables and queries used in calculating CO concentrations.

TABLES	QUERIES		
	1-minute data	15-minute data	Averages
EEquipment	CO cal	UpD CO 15 min Table	CO 48h
ERuns	CO cal mon		CO 1h running
	CO 1min sub		CO 1h max
CO calibrations	Co 1min cal		
CO1min			CO 8h running
CO15min	DBMq UpD mEnv		CO 8h max
TMAD			UpD CO Temp Avg Table

The formulas used in the concentration calculations are shown in Table 13.

Table 13. Formulas used in calculating the CO concentrations.

Query	Formula
CO cal	f: [conc] / (CoTCor([cal], [zero], 20))
CO cal mon	group by eid and mon: Year([Date])*100+Month([Date]) fmon as average of f, zmon as average of zero
CO 1min sub	CO1: IIf([co13]=12.8 Or [CO13]=-99, [co128], [co13]) mon: Year([start])*100+Month([start]) Temp: IIf([ExtT]=-99, [IntT], [ExtT])
CO 1min cal	CO: 1.164*CoTCor([CO1], [zmon], [IntT])*[fmon]

5.5. BS concentration calculation

The concentrations are calculated using values from the tables and the queries listed in Table 14.

Table 14. Tables and queries used in calculating BS concentrations.

TABLES	QUERIES		
	Reflectance calculation	Volume calculation	Absorption coefficient
ESamples	PM BS ref avg	Dur	PM BS ref coefficient
ERuns	PM BS ref A	PM Flows	PM BS durcoef
EFlows	PM BS ref4 avg	PM Flows std*	
EEquipment	PM BS ref4 A	PM Volumes	
ESetupDates		PM Volumes std*	
ECondSetup		PM Volumes std sub	
		ECo t	
PM BS raw			PM BS P1
PM BS ref			PM BS P2
			PM BS P48
Fixedruns			PM BS O
CO15min			PM BS I
			PM BS W
			PM BS IOWP1P2P48

* Queries integrated to versions without appended 'std' in the name in May 2002 version (see PM2.5).

The formulas used in the concentration calculations are shown in Table 15.

Table 15. Formulas used in calculating the BS concentrations.

Query	Formula
Dur	$\text{dur: Sum}(24 * ([\text{End}] - [\text{Start}]))$
PM BS ref avg	group by sid; avg as average of ref std as StDev of ref
PM BS ref A	$A: \text{IIf}([\text{env}] = "p", 0.0007547676, 0.0013202543)$
PM BS ref4 avg	group by spl: yjoint([ESamples].[spl])
PM BS ref4 A	$A: \text{IIf}([\text{env}] = "p", 0.0007547676, 0.0013202543)$
Dur, PM Flows, PM Volumes: see PM_{2.5}	
PM BS ref coefficient	$\text{coef: IIf}([\text{spl}] = "8",$ $(([\text{A}] / [\text{Vbest}]) * (\text{Log}(100 / [\text{ref4}]))) ,$ $(([\text{A}] / (2 * [\text{Vbest}])) * (\text{Log}(100 / [\text{ref4}]))))$
PM BS durcoef	$\text{durcoef: } [\text{coef}] * [\text{dur}] . [\text{dur}]$
PM BS I	sumEcoef as sum of durcoef durEnv as sum of dur $I: [\text{sumEcoef}] / [\text{durEnv}]$ where env="I"
(PM BS O, PM BS W, PM BS P1 and PM BS P2 similar)	
PM BS P48	$P48: \text{IIf}(([\text{PM BS P1}].[\text{cid}] \text{ Is Null}) \text{ Or}$ $([\text{PM BS P2}].[\text{cid}] \text{ Is Null}),$ $-9,$ $([\text{P1}] * [\text{durP1}] + [\text{P2}] * [\text{durP2}]) / ([\text{durP1}] + [\text{durP2}]))$

5.6. EAS concentration calculation

PM_{2.5} bound element concentrations were calculated based on the elemental analysis (EAS) results. The concentrations are calculated using values from the tables and the queries listed in Table 16.

Table 16. Tables and queries used in calculating EAS concentrations.

TABLES	QUERIES		
	Mass calculation	Volume calculation	Concentration
ESamples	PM m0	Dur	EAS c
ERuns	PM m1	PM Flows	
EFlows	PM m2	PM Flows std*	
EEquipment	PM m4	PM Volumes	
ESetupDates		PM Volumes std*	
ECondSetup		PM Volumes std sub	
		ECo t	
EAS blank correction	EAS ngm4		
EAS compounds	EAS bmasses		
EAS masses			
PM Filter samples	PM m4 SumOfMEM	PM Volumes SumOfMEM	EAS c4 MEM
PM Weighing conditions	EAS ng SumOfMEM		EAS c P1
			EAS c P2
Fixedruns			EAS c P48
CO15min			EAS c O
			EAS c I
			EAS c W

* Queries integrated to versions without appended 'std' in the name in May 2002 version (see PM2.5).

The formulas used in the concentration calculations are shown in Table 17

Table 17. Formulas used in calculating the EAS concentrations.

Query	Formula
EAS bmasses	bng_cm2: IIf([env]="P" And [EAS_DL]=1, [ng_cm2] - [beasPEM], IIf((([env]="I" Or [env]="O" Or [env]="W") And [EAS_DL]=1, [ng_cm2] - [beasMEM], [ng_cm2])))
EAS c	ng: IIf((([EAS ngm4] . [env])="P"), [ngm4] * 7.54767635, [ngm4] *13.20254313) EAS_c: [ng] / [Vbest] EAS_massc: [ng] / [m4]

5.7. Fixedruns concentration calculation

Averages of ambient pollutant concentrations and meteorological parameters corresponding to the sampling periods of the *EXPOLIS* samples were calculated using the sampling run information and the hourly/3-hourly fixed/meteorological station data.

The tables and queries used in the calculations are shown in Table 18.

Table 18. Tables and queries used in calculating the Fixedruns parameters.

TABLES	QUERIES
Fixed	Dur Ok
Met	Fixed run avg sub
ESamples	Fixed run avg
ERuns	Met run avg sub
	Met run avg
Fixedruns	

APPENDIXES

The following Appendixes are the original documentation for each specific part of the Concentration Query Network.

- I** *EXPOLIS Data Specifications for Questionnaire Data*. Otto Hänninen, 34 pages.
 - II** *EXPOLIS Dataentry*. Otto Hänninen, 50 pages.
 - III** *How to Calculate VOC Concentrations from the EXPOLIS Database*. Otto Hänninen, Sari Alm, Jouni Jurvelin and Esa Kaarakainen, 22 pages
 - IV** *How to Calculate NO₂ Concentrations from the EXPOLIS Database*. Otto Hänninen and Kirsi Kumpulainen, 16 pages.
 - V** *Calculating PM_{2.5} Concentrations from the EXPOLIS Database*. Otto Hänninen, Sari Alm, Kimmo Koistinen and Esa Kaarakainen, 40 pages.
 - VI** *EXPOLIS Local CO Database, User's Instructions for Updating to Version 9811* (with instruction sheets appended). Otto Hänninen and Esa Kaarakainen, 26 pages.
 - VII** *EXPOLIS Local CO Database, User's Manual*. Otto Hänninen and Esa Kaarakainen, 50 pages.
 - VIII** *Calculating Ambient Averages with the EXPOLIS Ambient Database*. Otto Hänninen, Juha Keski-Karhu and Esa Kaarakainen, 30 pages.
 - IX** *Black Smoke in EXPOLIS Database*. Sari Alm, Jutta Salo and Esa Kaarakainen, 12 pages.
 - X** *How to Calculate EAS Concentrations from the EXPOLIS Database*. Sari Alm, Esa Kaarakainen and Otto Hänninen, 10 pages.
 - XI** *Creating Final EXPOLIS Database*. Esa Kaarakainen, 28 pages.
 - XII** *EXPOLIS CIDB: Combined International Database*. Sari Alm, Esa Kaarakainen and Otto Hänninen, 52 pages.
-

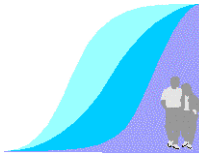

EXPOLIS

Exposure
Distributions
of Adult Urban
Populations

EXPOLIS DATA SPECIFICATIONS

FOR QUESTIONNAIRE DATA

The screenshot displays the HELSINKI Database application interface. The main window shows a list of tables and queries. A pop-up window titled 'P Stat : Table' displays the following table structure:

Field Name	Data Type	Description
cid	Number	ID for this person
answer	Text	'#' = not reached, 'a..'z' = questionnaire returned at stage 'x'. Null=no answer
stat	Text	Status: y=measurement agreed in phone; n=disagreed in phone; m=measured; d=dropped; l=later (TA
select	Number	Running number in the subsample selection 2000-2999 =exp+tad 3000-3999=tad only
rid	Text	Researcher initials
comment	Memo	Comments regarding the status of this customer

Below the table, the 'Field Properties' dialog is open for the 'cid' field. The 'General' tab is selected, showing the following properties:

- Field Size: Long Integer
- Format: (empty)
- Decimal Places: Auto
- Input Mask: (empty)
- Caption: (empty)
- Default Value: (empty)
- Validation Rule: (>0 And <70000) Or -9
- Validation Text: (empty)
- Required: Yes
- Indexed: Yes (No Duplicates)

A note on the right side of the dialog states: "A field name can be up to 64 characters long, including spaces. Press F1 for help on field names."

Otto Hänninen
KTL Environmental Health
P.O.Box 95
FI-70701 KUOPIO
FINLAND



SUMMARY

This document describes the data structures of Expolis study, including tables and table structures, fields and questionnaire variable classifications.

The measurement variables are not specified in this documentation. The measurement variables are described only in the EADB itself, in the field descriptions and lookup lists in table and form definitions. The need to define the measurement parameters in a written document should be discussed.

This document has been prepared by Otto Hänninen, who is responsible for the content and to whom the comments, questions and corrections should be addressed to.

Acknowledgements

The data structures in the EADB have been developed in tight co-operation and team work with both the Expolis Data Management contact group and the Expolis Helsinki team.

The data structures have been tested in Helsinki during the Expolis pilot and field stages. The support from Helsinki team members has been absolutely necessary to make the data structures functional. Also Datamanagement contact group has greatly contributed to the data specifications to make them functional and compatible with other data processing systems that have been or shall be linked to the Expolis database.

Tuulia Rotko with great effort from Lucy Oglesby and Lambros Georgoulis have streamlined the questionnaire parameter definitions. Evi Samoli and Lucy Oglesby have given very important feedback in selecting the parameters in each table and defining a functional coding for these parameters.

The Project Coordinator, Matti Jantunen has given his time and great insight in defining much of the functionality demands set for the data system.

Last but not least I thank my wonderful family who has supported my work during this prolonged intensive work period to define the EADB parameters.

CONTENTS

1. TERMS, ABBREVIATIONS AND CONVENTIONS	1
1.1. GENERAL TERMS	1
1.2. EADB KEY PARAMETERS	1
1.3. EADB CONVENTIONS	2
2. NAMES IN THE EADB	3
2.1. FIELDS	3
2.2. TABLES AND OTHER DATABASE OBJECTS	3
3. TABLES IN THE EADB	5
3.1. DATABASE MANAGEMENT	5
3.2. BOOK KEEPING TABLES	5
3.3. POPULATION SAMPLE	6
3.4. CUSTOMER SUBSAMPLE MEASUREMENTS	6
4. POPULATION VARIABLES	7
4.1. TABLE P STAT	7
4.2. TABLE P NAMES	8
4.3. TABLE P SHORTQ	9
4.3.1. PART 1 - BASEL INTERNATIONAL QUESTIONNAIRE PARAMETERS	9
4.3.2. PART 2 - BASEL INTERNATIONAL QUESTIONNAIRE, OPTIONAL PARAMETERS	11
4.3.3. PART 3 - PARAMETERS NOT IN BASEL INTERNATIONAL QUESTIONNAIRE	12
5. CUSTOMER QUESTIONNAIRE VARIABLES	14
5.1. TABLE EQLONG	14
5.1.1. PART 1 - QUESTIONNAIRE SOP PARAMETERS	14
5.2. TABLE EQ48HR	24
5.2.1. PART 1 - SOP QUESTIONNAIRE	24
5.2.2. PART 2 - PARAMETERS ADDED IN HELSINKI	26
5.3. TABLE EQHEALTH	26
6. MEASUREMENT VARIABLES	27

TABLES

<i>Table 2-1. The EADB table naming conventions. The beginning of the table name identifies the context..</i>	4
<i>Table 2-2. The EADB form naming conventions add the following name beginnings to the styles used for tables.....</i>	4

1. Terms, Abbreviations and Conventions

1.1. General terms

EADB	Expolis Access Database
Access	Microsoft Access version 7
DE	Dataentry
Query	A dynamic definition how to collect data from tables. Each time the query is run, the up to date data is retrieved from the tables.
Form	A dataentry view to the data in tables.
Record	A row in a table (contains one or more fields)
Field	A column in a table (parameter)
Null value	No value has been entered; variable is empty. This is the default value for EADB parameters; when a record is created, all values are empty.
Sample	A collected sample; eg. a filter or a tenax tube
Run	Uninterrupted sampling period (from time t_0 to time t_1)

1.2. EADB Key Parameters

The following short parameter names are referred in many places in the EADB. These are key fields that are used to identify data values.

sid	Expolis sample identification code
rid	Expolis researcher identification code
cid	Expolis customer identification code
eid	Expolis equipment identification code

The samples are identified by following codes

env	microenvironment:	I=home in,O=home out,W=work,P=personal
spl	sample	1,2 = filters,V=VOC,N=NO2
dup	duplicate/blank	1=main sample,2=duplicate,10,20 = blanks

1.3. *EADB Conventions*

-9	Missing value for all fields in EADB is -9 Different causes of missing data are not distinguished (eg. data not measured/asked, value lost/missing, parameter not applicable etc) Null value marks data not entered. All entered but missing data is coded as -9.
Ok-fields	What is the usability of the data on the record: 1 = data is ok 2 = there was a slight problem (specify in comment) but data is probably ok 3 = data is not ok
Comment fields	Describe the record; make the data 'alive': use comments! Comment the data on the record.

2. Names in the EADB

2.1. Fields

The fields can also be called parameters or variables. Each table consists of records. All records have fields according to the table definition.

Variables are named so that they could be exported to other systems without changing the variable name. Variables in the EADB are named according to following conventions:

- names are not case sensitive (but capitals can be used within EADB to make names more readable)
- names are alphanumeric
- names start with a letter; names do not contain spaces or punctuation characters
- the length of all field names is less than 9 characters (= 8 chars max)

- related variables try to keep the beginning of the name same
- t as last character is used for other specify text answers
- w as first character in many cases means work or winter

2.2. Tables and Other Database Objects

Database objects are sorted alphabetically in Access. The goal is to have the tables, queries etc. sorted in a logical order.

Names should be understandable.

Access allow long names with spaces and punctuation characters, which have been used to make the names more readable.

Table 2-1. The EADB table naming conventions. The beginning of the table name identifies the context..

Beginning	Explanation
A1	Database management, lookup tables
A2	Equipment book keeping
CO	CO monitor related data
DB	Database management
E	Exposure/TLADo customer measurement data
EQ	Customer questionnaires
NO2	NO2 measurement related data
P	Population sample data
PM	Particulate matter measurement data
VOC	VOC measurement related data

Table 2-2. The EADB form naming conventions add the following name beginnings to the styles used for tables.

Beginning	Explanation
C	Customers or population sample subjects
CA	All: population sample
CB	Both: exposure and TLADo customers
CE	Exposure customers
CT	TLADo customers
TASK	Some measurement related forms

3. Tables in the EADB

All data in the EADB is stored in tables. The data in the tables can be viewed and edited using queries and forms, but the data always resides in a table.

This section describes the tables in the EADB. The number of fields in each table is listed to describe the size of the records in the tables.

3.1. DATABASE MANAGEMENT

This section lists tables related to the data management and EADB operation.

Table	Fields	Explanation
A1 Researchers	3	List of researchers allowed to use the EADB (rid codes)
A1 Equipment	4	List of local equipment
DB Diary	4	Diary of (non routine) operations and modifications made to local EADB
DB Log	5	Log of EADB usage
Paste Errors	?	Table created by Access when pasting data to a table and the paste is not fully successful. Specifically formatted paste errors tables can be created for specific paste operations. Number of fields depend on the pasted data.

3.2. BOOK KEEPING TABLES

This section contains tables related to sampling media and other consumables related to Expolis measurements

Table	Fields	Explanation
A2 Eq intercalibrations	5	Intercalibrations/comparisons of similar type of equipment
A2 Equipment diary	4	Equipment history
CO calibration gas bottles	6	CO calibration gas bottle concentrations
CO calibrations	8	CO monitor calibrations
NO2 shipments	5	NO2 batch dates and tube counts
NO2 tubes	3	NO2 tube numbers
NO2 results	2	NO2 results
PM Filter lab blanks	7 (8)	Lab blank filter weighing results
PM Filter samples	9	Filter sample weighing results
PM Weighing conditions	9	Weighing room conditions
VOC compounds	4	VOC compound list, determining Expolis target compounds
VOC shipments	6	VOC tube batches
VOC tubes	4	VOC tube Expolis ids and stanssed codes
VOC masses	4	VOC mass results

3.3. POPULATION SAMPLE

These tables contain a record for all persons in the population sample (1000 - 3000 persons).

Table	Fields	Explanation
P Stat	6	Customer status in the database and the Expolis measurement procedure
P NAMES	20	Customer private information, like name, address, phonenumbers
P ShortQ	48	Population sample parameters from Civil Register and Mailed/Interviewed Questionnaire

3.4. CUSTOMER SUBSAMPLE MEASUREMENTS

These tables contain a record for persons that have been contacted during the Expolis measurement procedures.

The subsamples column in following table shows which population subsample groups do have a record in each table.

Subsamples		Table	Fields	Explanation
Exp	TLADo			
x	x	EContact	9	Contacting information (visit dates, working hours)
x		ECondCustomer	9	Conditions (T, RH) in the customer's μ Environments
x		ECondSetup	10	Conditions during flow measurements
x		ESetupDates	4	Setup dates for the Customer
x		EEquipment	10	Equipment id numbers for the Customer
x		ESamples	5	Sample id numbers for the Customer
x		EFlows	11	Flow measurement for a Customer setup
x		ERuns	7	Runs for all samples
x		EPositioning	10	Customer equipment positioning
x	x	EDownload	5	CO file and TLAD diary comments
x	x	ELongQ	130	Long questionnaire
x	x	E48hQ	63	48h activity questionnaire
x	x	EHealthQ	31	Basel specific health questionnaire

4. Population Variables

This section describes the coding values used in database variables and explains the coding practices and principles. Variables are presented in database table order and are divided into subsections inside tables, when necessary.

Key fields (used to link information between tables) are marked with ✕.

4.1. TABLE P Stat

This table contains variables that describe the persons status.

FIELD	Explanation	Coding
✕cid	personal ID, running number	00001...19999 Helsinki. 20000...29999 Athens 30000...39999 Basel 40000...49999 Grenoble 50000...59999 Milan 60000...69999 Prague
answer	marking persons that have answered	empty=no answer # = the address is not valid a = answer to 1.st mailing b = answer to 2.nd mailing c = answer to 3.rd mailing ... p = aswer to phone interview x = pilot volunteer define local answer stages as necessary (above definitions are for Helsinki)
select	person has been drawn for measurement	empty = person has not been drawn 1001-9999 ordinal number in sample 2001-2999 exposure sample 3001-3999 TLADo sample
stat	persons status in customer procedure	empty = person has not been contacted y = person agreed measurement in phone yg = agreed to TLAD group n = person disagreed in phone l = measurement maybe later m = person has been measured mg = TLADo measured in group mm = TLADo measured by mail
rid	researcher id	unique initials (across Europe)
comment	any comments regarding the status of this customer	text

4.2. TABLE P NAMES

Table P NAMES contains the personal information. All information needed to be deleted after measurement is stored in this table. Some areal information is kept for later analysis.

FIELD	Explanation	Coding
xcid	personal ID, running number	(see table PStat for number spaces)
name	familyname and optionally fore name(s) of the person	text
fname	fore name(s) of the person	text
street	street address (optionally with street number)	text (keep street name)
streetnr	building number, door	text
zip	postal code of the persons home address	text (keep)
city	post office (city name, post office number)	text (keep)
cityq	city quarter	text (keep) (define values locally)
staco	street code	text (keep) (define values locally)
spouse	name of spouse (if any)	text
hphone	phone number to home	text
wstreet	street address (optionally with street number)	text (keep street name)
wstreetn	building number, door	text
wzip	postal code of the persons home address	text (keep)
wcity	post office (city name, post office number)	text (keep)
wphone	phone number to work	text
wcityq	city quarter	text (keep) (define values locally)
wstaco	street code	text (keep) (define values locally)
pnok	is this record ok?	1=ok 2=some problem (usable with care) 3=error (data not usable)
comment	any comments regarding the data	text

4.3. TABLE P ShortQ

This table contains parameters obtained from the population sample (1000 - 3000 persons).

All parameters asked in any center are included; thus parameters not asked in a particulate center will have empty (null) or missing (-9) value.

Fields/values added after the International Questionnaire version 30.9.1996 are marked with *.

4.3.1. Part 1 - Basel International Questionnaire parameters

FIELD	Explanation	Coding
xcid	personal ID, running number	(see table PStat)
adate	answer date	date [dd.mm.yy]
sex	gender of the customer	1=male, 2=female
birthyr	year of birth	4 digit integer, 1939..1971
eduyr	years of education	integer
eduyrc	still studying fulltime	1=yes, 2=no
wplace	In what kind of a place does the person work in	1=working home 2=working indoors, in one place 3=working in one building 4=working outdoors in one place 5=working in traffic 6=other (specify) 7=not working * 8=many places *
wplacet	workplace = 6, other; specify	text
adults	number of adult (>=18) family members	integer
children	number of children (<18) family members	integer
hrout	hours spent outdoors yesterday	float (eg. 1.25 = 1h15min)

FIELD	Explanation	Coding
hlocB	home location type	1=center of city/village, high traffic 2=center of city/village, low traffic 3=periphery, close to traffic 4=periphery, low traffic 5=periphery, no traffic This question is used in Basel
htraffic	amount of heavy traffic close to home	1=all the time 2=often 3=rarely 4=never
Swalkt	Summer walking time [min]	integer
Wwalkt	Winter walking time [min]	integer
Smotot	Summer motor bike time [min]	integer
Wmotot	Winter motor bike time [min]	integer
Scart	Summer car driving time [min]	integer
Wcart	Winter car driving time [min]	integer
Sbust	Summer bus time [min]	integer
Wbust	Winter bus time [min]	integer
Sstraint	Summer train time [min]	integer
Wstraint	Winter train time [min]	integer
wheez	Wheezing or whistling during last 12 months	1=yes, 2=no, 3=don't know
astma	Astma attack during last 12 months	1=yes, 2=no, 3=don't know
nasal	Nasal allergies, hay fever	1=yes, 2=no, 3=don't know
ssmoke	Regular smoking (1 cigarette/day for last year)	1=yes 2=no
particip	Is the person willing to participate the measurements	1=yes 2=yes, diary study only 3=no, don't want to 4=no, not living/working in the area 5=no, most of the time not in the area

4.3.2. Part 2 - Basel International Questionnaire, Optional parameters

FIELD	Explanation	Coding
marital	Marital status given by the person	1=married 2=not married 3=divorced 4=widow
occup	Occupational status	1= employed 2= self employed (entrepreneur) 3= unemployed 4= housewife 5= student 6= retired 7=other (specify)
occupst	occupstat specification	text
occupat	Occupational title	text
sens	Is the person sensitive to noise or air pollution	1=sensitive to noise 2=sensitive to air pollution 3=not sensitive 4=sensitive to both noise and air pollution

4.3.3. Part 3 - Parameters not in Basel International Questionnaire

FIELD	Explanation	Coding
nat *	nationality group	text (define local coding)
harea	home floor area in [m ²]	integer
htype	type of home building	1=separate house 2=attached house 3=high rise
hsmoke	Someone else smoking at home	1=yes, indoors 2=yes, but only outdoors 3=no one is smoking at home
stove	Stove used for cooking at home	1=electric 2=gas 3=wood/coal 4=electric and gas 5=electric and wood/coal 6=gas and wood/coal
wloc	In what kind of surroundings is the workplace located	1=Center of the city 2=Commercial zone 3=Industry area 4=High rise building area 5=Small building area 6=Rural area 7=Traffic dominated area 8=Many places *
wwalkd	Winter walking distance [km]	integer
wmotod	Winter motorbike distance [km]	integer
wcard	Winter car driving distance [km]	integer
wbusd	Winter bus distance [km]	integer
wtraind	Winter train distance [km]	integer
occupcl	Occupational status employed subclassing according to finnish statistical center	1= farmer 2= entrepreneur 3= white collar 4= blue collar 5= worker 6= student 7= retired 8= other (eg. Housewife, unemployed) Finnish Statistical Center classification

FIELD	Explanation	Coding
eduAth *	education class for Athens	1=no education (illiterate) 2= at least few years elementary school 3= at least few years 3-grade high school 4= at least few years 6-grade high school 5= at least few years Lyceum 6= at least few years university or technical school This variable is for Greek education system, used in Athens
psok	is this record ok?	1=ok 2=some problem (usable with care) 3=error (data not usable)
comment	any comments regarding the data	text

5. Customer Questionnaire Variables

5.1. TABLE EQLong

This table contains parameters in the long questionnaire.

All parameters asked in any center are included; thus parameters not asked in a particulate center will have empty (null) or missing (-9) value.

5.1.1. Part 1 - Questionnaire SOP parameters

FIELD	Explanation and Coding
xcid	personal ID (see table PStat for coding)
homeloc	IQ1 1=down town 2=suburban area w. high rises 3=suburban, small buildings 4=industrial area 5=other
homeloc_t	IQ1 Home location explanation (if 5=other)
homeb	IQ2 1=single family detached 2=single family, attached 3=office/appartement building 4=industrial building 5=other
homeb_t	IQ2 Home building type explanation (if 5=other)
floor	IQ3 Home floor 0=ground level
builtyr	IQ4 Home building is built 1=after 1989 2=1980-89 3=1970-79 4=before 1970 5=don't know
area	IQ5 floor area in [m ²], including all rooms
roomhght	IQ6 Room height [m]
traf	IQ7 Traffic volume on the nearby street 1=heavy, continuous, 2=medium, 3=light
htraf	IQ8 Truck/heavy vehicle traffic volume on the nearby street 1=all the time 2=often 3=rarely 4=never

FIELD	Explanation and Coding
garage	IQ9 1;yes; 2;no; 3;don't know
wwcarpt	IQ10 Wall to wall carpet 1;yes; 2;no;- 9;missing
ocarpt	IQ10 Other carpet 1;yes; 2;no; -9;missing
curtain	IQ10 Curtains 1;yes; 2;no; -9;missing
furnish	IQ10 Soft furnishings 1;yes; 2;no; -9;missing
dglaz	IQ10 Double glazing 1;yes; 2;no; -9;missing
linol	IQ10 Linoleum floor 1;yes; 2;no; -9;missing
PVC	IQ10 PVC (plastic) floor 1;yes; 2;no; -9;missing
Woodflo	IQ10 Wooden floor 1;yes; 2;no; -9;missing
Woodpan	IQ10 Wooden panels 1;yes; 2;no; -9;missing
Plaster	IQ10 Plaster board walls/ceilings 1;yes; 2;no; -9;missing
Chipbrd	IQ10 Chipboard walls 1;yes; 2;no; -9;missing
wallpap	IQ10 Wallpaper (any kind) 1;yes; 2;no; -9;missing
none1	IQ10 None above alternatives 1;yes; 2;no; -9;missing

FIELD	Explanation and Coding
renowal	IQ11 Wall painting/paper renovation in last year 1;yes; 2;no; -9;missing
renoflo	IQ11 Floor repair/polish/varnishing in last year 1;yes; 2;no; -9;missing
renowat	IQ11 Water/sewage system renovation in last year 1;yes; 2;no; -9;missing
renowin	IQ11 Window/door renovation in last year 1;yes; 2;no; -9;missing
renoins	IQ11 Insulation renovation in last year 1;yes; 2;no; -9;missing
wallcon	IQ11 Wall construction/removal in last year 1;yes; 2;no; -9;missing
none2	IQ11 None above alternatives 1;yes; 2;no; -9;missing
waterd	IQ12 Damages in previous question caused by water 1;yes; 2;no; -9;missing
waterdn	IQ13 Is there any water damage that has not been fixed 1;yes; 2;no; -9;missing
cats	IQ14 Number of pets in customer's home
dogs	IQ14 Number of pets in customer's home
birds	IQ14 Number of pets in customer's home
other	IQ14 Number of pets in customer's home
othert	IQ14 Other animals explanation
smoking	IQ15 How many persons smoke in the home (including the recipient)
cigaret	IQ16 How many are consumed per day inside the home
cigarlo	IQ16 How many are consumed per day inside the home
cigars	IQ16 How many are consumed per WEEK inside the home
pipeful	IQ16 How many are consumed per WEEK inside the home

FIELD	Explanation and Coding
heatdis	IQ17 Home heating: district heating 1;yes; 2;no; -9;missing
heatcen	IQ17 Home heating: central heating in the building 1;yes; 2;no; -9;missing
heatele	IQ17 Home heating: single stoves/heaters with electricity 1;yes; 2;no; -9;missing
heatgas	IQ17 Home heating: single stoves/heaters with gas 1;yes; 2;no; -9;missing
heatcoa	IQ17 Home heating: single stoves/heaters with coal 1;yes; 2;no; -9;missing
heatwoo	IQ17 Home heating: single stoves/heaters with wood 1;yes; 2;no; -9;missing
heatker	IQ17 Home heating: single stoves/heaters with kerosene/parafine 1;yes; 2;no; -9;missing
heatoil	IQ17 Home heating: single stoves/heaters with fuel/oil 1;yes; 2;no; -9;missing
heatfir	IQ17 Home heating: fire place 1;yes; 2;no; -9;missing
heatnon	IQ17 Home heating: no heating 1;yes; 2;no; -9;missing
heatoth	IQ17 Other heating (specify) 1;yes; 2;no; -9;missing
heatott	IQ17 Home heating, explanation

FIELD	Explanation and Coding
aircond	IQ18 Air conditioning in the home 1;yes; 2;no; -9;missing
humidif	IQ18 Humidifier in the home 1;yes; 2;no; -9;missing
aircl	IQ18 Electric/filter cleaner or ionizer in the home 1;yes; 2;no; -9;missing
airnone	IQ18 None above 1;yes; 2;no; -9;missing
cookeel	IQ19 Cooking by electricity 1;yes; 2;no; -9;missing
cookgas	IQ19 Cooking by gas 1;yes; 2;no; -9;missing
cooksol	IQ19 Cooking by solid fuel(s) 1;yes; 2;no; -9;missing
cookoth	IQ19 Cooking by other (specify) 1;yes; 2;no; -9;missing
cooknon	IQ19 No cooking in home 1;yes; 2;no; -9;missing
cookt	IQ19 Cooking by other energy: specify
cookfan	IQ20 Kitchen fan/vent 1;yes, air back to kitchen; 2;yes, extractor with switch; 3;yes, connected to ventillation; 4;no; 5;I don't know
naphtal	IQ21 Do you use anti-moth products 1;yes; 2;no; 3;don't know; -9;missing
freshen	IQ22 Do you use air fresheners 1;yes; 2;no; 3;don't know; -9;missing
freshent	IQ23 Brand names of used air fresheners (if any)

FIELD	Explanation and Coding
WWalkt	IIQ1 One way commuting to work in winter : time spent walking [min]
WMotot	IIQ1 One way commuting to work in winter : time spent on motorcycle [min]
WCart	IIQ1 One way commuting to work in winter : time spent in car/taxi [min]
WBust	IIQ1 One way commuting to work in winter : time spent in bus/tram [min]
WTraint	IIQ1 One way commuting to work in winter : time spent in train/metro [min]
wplace	IIIQ0 1;in, one spot; 2;one building; 3;home; 4;out one spot; 5;traffic; 6;not working; 7;many places; -9;missing
persons	IIIQ1 How many persons normally work in the same room (including yourself)
wsmoke	IIIQ2 How many of the persons smoke in the work room
wcigaret	IIIQ3 How many are consumed per day in the work room
wcigarlo	IIIQ3 How many are consumed per day in the work room
wcigars	IIIQ3 How many are consumed per WEEK in the work room
wpipeful	IIIQ3 How many are consumed per WEEK in the work room
wfloor	IIIQ4 Work room floor 0=ground level
wwwcarpt	IIIQ5 Wall to wall carpet 1;yes; 2;no; -9;missing
wocarpt	IIIQ5 Other carpet 1;yes; 2;no; -9;missing
wcurtain	IIIQ5 Curtains 1;yes; 2;no; -9;missing
wfurnish	IIIQ5 Soft furnishings 1;yes; 2;no; -9;missing
wzglaz	IIIQ5 Double glazing 1;yes; 2;no; -9;missing
wlinol	IIIQ5 Linoleum floor 1;yes; 2;no; -9;missing
wPVC	IIIQ5 PVC (plastic) floor 1;yes; 2;no; -9;missing
wWoodflo	IIIQ5 Wooden floor 1;yes; 2;no; -9;missing

FIELD	Explanation and Coding
wWoodpan	IIIQ5 Wooden panels 1;yes; 2;no; -9;missing
wPlaster	IIIQ5 Plaster board walls/ceilings 1;yes; 2;no; -9;missing
wChipbrd	IIIQ5 Chipboard walls 1;yes; 2;no; -9;missing
wwallpap	IIIQ5 Wallpaper (any kind) 1;yes; 2;no; -9;missing
wnone1	IIIQ5 None above alternatives 1;yes; 2;no; -9;missing

FIELD	Explanation and Coding
workloc	IIIQ6 1=down town 2=suburban area w. high rises 3=suburban, small buildings 4=industrial area 5=other
workloct	IIIQ6 Work location explanation (if 5=other)
workb	IIIQ7 1=single family detached 2=single family, attached 3=office or appartement building 4=industrial building 5=other
workbt	IIIQ7 Work building type explanation (if 5=other)
wtraf	IIIQ8 Traffic volume on the nearby street 1=heavy, continuous, 2=medium, 3=light
whtraf	IIIQ9 Truck/heavy vehicle traffic volume on the nearby street 1=all the time 2=often 3=rarely 4=never
wbuiltyr	IIIQ10 1=after 1989 2=1980-89 3=1970-79 4=before 1970 5=don't know
wrenowal	IIIQ11 Wall painting/paper renovation in last year 1;yes; 2;no; -9;missing
wrenoflo	IIIQ11 Floor repair/polish/varnishing in last year 1;yes; 2;no; -9;missing
wrenowat	IIIQ11 Water/sewage system renovation in last year 1;yes; 2;no; -9;missing
wrenowin	IIIQ11 Window/door renovation in last year 1;yes; 2;no; -9;missing
wrenoins	IIIQ11 Insulation renovation in last year 1;yes; 2;no; -9;missing
wwallcon	IIIQ11 Wall construction/removal in last year 1;yes; 2;no; -9;missing
wnone2	IIIQ11 None above alternatives 1;yes; 2;no; -9;missing

FIELD	Coding
wwaterd	IIIQ12 Damages in previous question caused by water 1;yes; 2;no; 3;don't know; -9;missing
wwaterdn	IIIQ13 Is there any water damage that has not been fixed 1;yes; 2;no; 3;don't know; -9;missing
wheatdis	IIIQ14 Work heating: district heating 1;yes; 2;no; -9;missing
wheatcen	IIIQ14 Work heating: central heating in the building 1;yes; 2;no; -9;missing
wheatele	IIIQ14 Work heating: single stoves/heaters with electricity 1;yes; 2;no; -9;missing
wheatgas	IIIQ14 Work heating: single stoves/heaters with gas 1;yes; 2;no; -9;missing
wheatcoa	IIIQ14 Work heating: single stoves/heaters with coal 1;yes; 2;no; -9;missing
wheatwoo	IIIQ14 Work heating: single stoves/heaters with wood 1;yes; 2;no; -9;missing
wheatker	IIIQ14 Work heating: single stoves/heaters with kerosene/parafine 1;yes; 2;no; -9;missing
wheatoil	IIIQ14 Work heating: single stoves/heaters with fuel/oil 1;yes; 2;no; -9;missing
wheatfir	IIIQ14 Work heating: fire place 1;yes; 2;no; -9;missing

FIELD	Explanation and Coding
wheatnon	IIIQ14 Work heating: no heating 1;yes; 2;no; -9;missing
wheatoth	IIIQ14 Other heating (specify) 1;yes; 2;no; -9;missing
wheatott	IIIQ14 Work heating, explanation
waircond	IIIQ15 Air conditioning in the home 1;yes; 2;no; -9;missing
whumidif	IIIQ15 Humidifier in the home 1;yes; 2;no; -9;missing
waircl	IIIQ15 Electric/filter cleaner or ionizer in the home 1;yes; 2;no; -9;missing
wairnone	IIIQ15 None above 1;yes; 2;no; -9;missing
plok	1;ok; 2;commented; 3;error
comment	Comments for this record

5.2. TABLE EQ48hr

This table contains parameters in the 48 activity questionnaire, which is appended to the customer long questionnaire.

All parameters asked in any center are included; thus parameters not asked in a particulate center will have empty (null) or missing (-9) value.

5.2.1. Part 1 - SOP questionnaire

FIELD	Explanation and Coding
xcid	Customer ID for this person
usegas	IQ1 How long (decimal number, eg. 1.25 = 1h 15 min) was gas stove used?
Usecoal	IQ1 How long (decimal number, eg. 1.25 = 1h 15 min) was coal stove used?
Usewood	IQ1 How long (decimal number, eg. 1.25 = 1h 15 min) was wood stove used?
Usekero	IQ1 How long (decimal number, eg. 1.25 = 1h 15 min) was kerosene stove used?
Useoil	IQ1 How long (decimal number, eg. 1.25 = 1h 15 min) was oil stove used?
Usefire	IQ1 How long (decimal number, eg. 1.25 = 1h 15 min) was fire place used?
Usefan	IQ1 How long (decimal number, eg. 1.25 = 1h 15 min) was kitchen fan used?
Useair	IQ1 How long (decimal number, eg. 1.25 = 1h 15 min) was air conditioning used?
Usehum	IQ1 How long (decimal number, eg. 1.25 = 1h 15 min) was humidifier used?
Useairc	IQ1 How long (decimal number, eg. 1.25 = 1h 15 min) was air cleaner used?
Usegaswh	IQ1 How long (decimal number, eg. 1.25 = 1h 15 min) was gas water heater used?
Useeldr	IQ1 How long (decimal number, eg. 1.25 = 1h 15 min) was electric dryer used?
Usegasdr	IQ1 How long (decimal number, eg. 1.25 = 1h 15 min) was gas dryer used?
Usesauna	IQ1 How long (decimal number, eg. 1.25 = 1h 15 min) was wood heated sauna used?
Useelc	IQ1 How long (decimal number, eg. 1.25 = 1h 15 min) was electric cooking stove used?
Usegasc	IQ1 How long (decimal number, eg. 1.25 = 1h 15 min) was gas cooking stove used?
Usesolid	IQ1 How long (decimal number, eg. 1.25 = 1h 15 min) was solid fuel cooking stove used?
Vacuum	IQ2 Vacuum cleaning 1;yes I did ;2;yes, some one else did;3;no;-9;missing
chemical	IQ3 Brand names of cleaning chemicals
window	IQ4 How long (decimal number, eg. 1.25 = 1h 15 min) was a window open in the home?
Wusegas	IIQ1 How long (decimal number, eg. 1.25 = 1h 15 min) was gas stove used?
Wusecoal	IIQ1 How long (decimal number, eg. 1.25 = 1h 15 min) was coal stove used?
Wusewood	IIQ1 How long (decimal number, eg. 1.25 = 1h 15 min) was wood stove used?
Wusekero	IIQ1 How long (decimal number, eg. 1.25 = 1h 15 min) was kerosene stove used?
Wuseoil	IIQ1 How long (decimal number, eg. 1.25 = 1h 15 min) was oil stove used?
Wusefire	IIQ1 How long (decimal number, eg. 1.25 = 1h 15 min) was fire place used?
Wuseair	IIQ1 How long (decimal number, eg. 1.25 = 1h 15 min) was air conditioning used?
Wusehum	IIQ1 How long (decimal number, eg. 1.25 = 1h 15 min) was humidifier used?
Wuseairc	IIQ1 How long (decimal number, eg. 1.25 = 1h 15 min) was air cleaner used?
Wwindow	IIQ2 How long (decimal number, eg. 1.25 = 1h 15 min) was a window open in workplace?
Photoc	IIQ3 How long (decimal number, eg. 1.25 = 1h 15 min) was a photocopy machine or printer used?

FIELD	Explanation and Coding
photos	IIIQ1 Hours used to develop photographs
paint	IIIQ1 Hours used to paint
glue	IIIQ1 Hours used to glue
workshop	IIIQ1 Hours used in workshop
carwash	IIIQ1 Hours used to wash car
gasstat	IIIQ1 Hours used in gas station
gasoline	IIIQ1 1;gasoline;2;diesel;-9;missing
grilling	IIIQ1 Hours used to grill
garage	IIIQ1 Hours used in garage
exero	IIIQ1 Hours used to exercise outdoors
exeri	IIIQ1 Hours used to exercise indoors
hockey	IIIQ1 Hours used in icehockey ring
parfume	IIIQ2 Parfume use 1;yes;2;no;3;don't remember;-9;missing
drycloth	IIIQ2 Use of dry cleaned clothes 1;yes;2;no;3;don't remember;-9;missing
airpola	IVQ1 How much did the air pollutants annoy you in home 0-10
airpolc	IVQ2 1;dust;2;exhaust;3;chemicals;4;other (specify)
airpolt	IVQ2 other specify text
wairpola	IVQ1 How much did the air pollutants annoy you in work 0-10
wairpolc	IVQ2 1;dust;2;exhaust;3;chemicals;4;other (specify)
wairpolt	IVQ2 other specify text
tairpola	IVQ1 How much did the air pollutants annoy you in traffic 0-10
tairpolc	IVQ2 1;dust;2;exhaust;3;chemicals;4;other (specify)
tairpolt	IVQ2 other specify text
case	VQ1 Case with customer whole period 1;yes;2;no;-9;missing
caset	VQ1 When the case was not with the customer
p4ok	1;ok;2;commented;3;error
comment	Comments for this record

5.2.2. Part 2 - Parameters Added in Helsinki

These questions are part of the Short Questionnaire definition, but have not been asked in Helsinki version. Thus similar questions were added to the Long Questionnaire in Helsinki. The answers are stored into the end of EQ48h table.

FIELD	Explanation and Coding
eduyr	Years of education
wheez	Wheezing during last 12 months: 1;yes;2;no;3;don't know
astma	Astma attack during last 12 months: 1;yes;2;no;3;don't know
nasal	Nasal allergies, hay fever during last 12 months: 1;yes;2;no;3;don't know

5.3. TABLE EQHealth

This table contains health related parameters asked in Basel.

FIELD	Explanation and Coding
xcid	Customer ID
S127	Years in community
S128	Years in home
S001	Wheezing during last 12 months 1;yes;2;no;3;don't know;-9;missing
S002	Breathless when wheezing 1;yes;2;no;3;don't know;-9;missing
S003	Wheezing without cold 1;yes;2;no;3;don't know;-9;missing
S007	Woken by feeling of tightness 1;yes;2;no;3;don't know;-9;missing
S010	Woken by shortness of breath 1;yes;2;no;3;don't know;-9;missing
S011	Woken by cough attack 1;yes;2;no;3;don't know;-9;missing
S012	Morning cough 1;yes;2;no;3;don't know;-9;missing
S014	Cough during day/night 1;yes;2;no;3;don't know;-9;missing
S015	Cough most days for 3 months 1;yes;2;no;3;don't know;-9;missing
S018	Phlegm at morning 1;yes;2;no;3;don't know;-9;missing
S020	Phlegm during day/night 1;yes;2;no;3;don't know;-9;missing
S021	Phlegm most days for 3 months 1;yes;2;no;3;don't know;-9;missing
S031	Ever had astma 1;yes;2;no;3;don't know;-9;missing
S032	Astma confirmed by doctor 1;yes;2;no;3;don't know;-9;missing
S036	Astma attack during 12 months 1;yes;2;no;3;don't know;-9;missing
S037	How many astma attacks during 12 months
S038	Taking astma medicine 1;yes;2;no;3;don't know;-9;missing
S039	Nasal allergies or hay fever 1;yes;2;no;3;don't know;-9;missing
S051	Did mother smoke 1;yes;2;no;3;don't know;-9;missing
S064	Had mother astma 1;yes;2;no;3;don't know;-9;missing
S066	Had farther astma 1;yes;2;no;3;don't know;-9;missing
S084	Change job because breathing 1;yes;2;no;3;don't know;-9;missing
S086	Exposed to dust in job 1;yes;2;no;3;don't know;-9;missing
R001	Regular smoker now 1;yes;2;no;3;don't know;-9;missing
R002	Regular smoker 1991 1;yes;2;no;3;don't know;-9;missing
R003	Compared to 1991 do you smoke 1;less than 1991;2;equal to 1991;3;more than 1991;-9;missing
ok	Is the questionnaire record ok: 1;ok;2;? (specify);3;err
comment	Comments regarding the data in this record

6. Measurement Variables

The measurement related variables are currently defined only in the EADB.

The coding is specified in the drop down list boxes from which the values are selected during dataentry in the status bar text in the bottom of Access window, which shows the field descriptions from table definitions.

It should be discussed if further documentation for this group of variables is needed.

Following is a list of tables for which the field definitions are not presented in this document in its current state. For some of the database management tables the fields are described partly in the Expolis Dataentry documentation.

Table	Available documentation for fields
A1 Researchers	Expolis Dataentry
A1 Equipment	Expolis Dataentry
DB Diary	Short discussion in Expolis Dataentry
DB Log	Short discussion in Expolis Dataentry
Paste Errors	Short discussion in Expolis Dataentry
A2 Eq intercalibrations	none
A2 Equipment diary	Mentioned in Expolis Dataentry
CO calibration gas bottles	Expolis Dataentry shows DE form
CO calibrations	Expolis Dataentry shows DE form
NO2 shipments	Expolis Dataentry shows DE form
NO2 tubes	Expolis Dataentry shows DE form
NO2 results	none *
PM Filter lab blanks	Expolis Dataentry shows DE form
PM Filter samples	Expolis Dataentry shows DE form
PM Weighing conditions	Expolis Dataentry shows DE form
VOC compounds	none
VOC shipments	Expolis Dataentry shows DE form
VOC tubes	Expolis Dataentry shows DE form
VOC masses	Expolis Dataentry shows DE form
EContact	Expolis Dataentry shows DE form
ECondCustomer	Expolis Dataentry shows DE form
ECondSetup	Expolis Dataentry shows DE form
ESetupDates	Expolis Dataentry shows DE form (Flows)
EEquipment	Expolis Dataentry shows DE form
ESamples	Expolis Dataentry shows DE form
EFlows	Expolis Dataentry shows DE form
ERuns	Expolis Dataentry shows DE form
Epositioning	Expolis Dataentry shows DE form
Edownload	Expolis Dataentry shows DE form

*) the result parameter (Abs vs. Conc) is not fixed yet. OH 20.3.1997

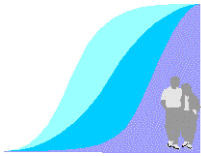

EXPOLIS

Exposure
Distributions
of Adult Urban
Populations

EXPOLIS DATAENTRY

Entering data into the EADB

8.4.1997

Welcome to the Expolis Access database.

Please follow the steps 1 and 2.
All we electrons, pixels, megahertz and program code hope that you feel like home here...

1. Please tell me who you are ID

2. Select what you want to do and press the button

Weighing

Weighing room conditions

Lab blank masses

Sample filter pre masses

Sample filter after masses

Langan

Calibrations CO Bottles

Tubes **VOC** **NO2**

Receive

Send back

Import Results

Working with a customer

Customers

Names

ShortQ data

Contacting customers Exp TLADo

Setting up measurement

Equipment CustCond

Samples SetupCond.

After measurement

Flows/dates CustCond.

Runs SetupCond.

Positioning LongQ data

Closing customer

Summary

Privacy

Database Diary Log News Eq diary Exit

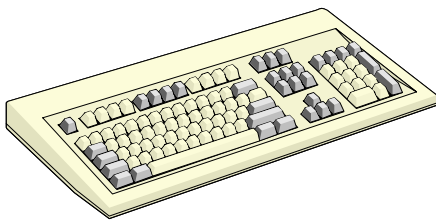

Otto Hänninen

KTL Environmental Health
P.O.Box 95
FI-70701 KUOPIO
FINLAND

**EXPOLIS**Exposure
Distributions
of Adult Urban
Populations**KTL ENVIRONMENTAL HEALTH**Mannerheimintie 166
FI-00300 HELSINKI
FINLAND

Otto Hänninen

International tel. +358-9-5885 182
International fax +358-9-4744 786
E-mail/internet OTTO.HANNINEN@KTL.FI

DATA ENTRY DOCUMENTATIONVersion 8.4.1997

SUMMARY

This document describes the data entry procedures to the Expolis Access Database (EADB).

The data is stored nationally on a Microsoft Access version 7 database.

The national databases are combined into an international database by KTL. Tools and guidelines for collecting and storing this data are provided to each partner.

This document has been prepared by Otto Hänninen, who is responsible for the content and whom the comments, questions and corrections should be addressed to. The purpose of this information is to make working with EADB easier and to help everyone provide consistent high quality data for scientific analysis. Any comments and questions helping to add towards this goal are warmly welcome.

Acknowledgements

The data structures in the EADB have been developed in tight co-operation and team work with both the Expolis Data Management contact group and the Expolis Helsinki team.

Especially valuable for the development of the database system has been the patient testing done by the Helsinki team members. Tuulia Rotko with great effort from Lucy Oglesby and Lambros Georgoulis have streamlined the questionnaire parameter definitions. Tuija Stambej has tested along with Tuulia Rotko the questionnaire data entry tools and brought up development needs also in the exposure measurement dataentry tools.

Evi Samoli and Lucy Oglesby have given very important feedback in selecting the parameters in each table and defining a functional coding for these parameters. Kimmo Koistinen has helped in selecting the measurement parameters, Anu Kousa has formulated most of the field work paper files, which formed the bases for the database development. Jouni Jurvelin has developed the VOC parameter handling for transferring data between centers and VTT and Anna-Maija Piippo has tested both the VOC and NO2 tube handling procedures.

The Project Coordinator, Matti Jantunen has given his time and great insight in formulating the responsibilities between different parties working with the data as well as the formulating the data management system for this international multicenter study.

Last but not least I must thank my wonderful family who has supported my work during this prolonged development period, which has lasted from the planning to the current state of the database full 12 months.

CONTENTS

1. TERMS, ABBREVIATIONS, CONVENTIONS AND KEYS	1
1.1. GENERAL TERMS	1
1.2. EADB KEY PARAMETERS	1
1.3. DOCUMENT CONVENTIONS	2
1.4. EADB CONVENTIONS	2
1.5. EADB SPECIAL KEYS	3
1.6. ACCESS SPECIAL KEYS	3
1.7. WINDOWS KEYS	3
2. BASICS OF WORKING WITH THE EADB	4
2.1. HARDWARE AND SOFTWARE REQUIREMENTS	4
2.2. USERS AND ADMINISTRATORS	4
2.3. BACKUPS	5
2.4. WELCOME SCREEN	5
2.5. DATABASE WINDOW	6
2.6. FORMS AND QUERIES	6
2.7. DATABASE DIARY	7
2.8. DATABASE LOG	7
2.9. THE NEWS FILE	7
2.10. EQUIPMENT DIARY	7
3. MAKING THE LOCAL EADB FUNCTIONAL	8
3.1. PLACING THE .MDB FILE ON A DISK	8
3.1.1. EADB INSTALLATION STEPS	8
3.2. LOOKUP TABLES	10
3.2.1. TABLE A1 EQUIPMENT	10
3.2.2. TABLE A1 RESEARCHERS	11
4. IMPORTING DIGITAL DATA	12
4.1. TRANSFORMING VARIABLES	12
4.2. IMPORTING DATA FROM EXCEL	12
4.2.1. PASTE ERRORS TABLE	12
4.3. IMPORTING DATA USING ASCII FILES	13
4.4. CHECKING DATA AFTER TRANSFER	13
5. VOC AND NO2 SAMPLING TUBES	14
5.1. VOC TUBES	14
5.1.1. RECEIVING VOC TUBE SHIPMENT	14
5.1.2. SENDING VOC TUBES BACK FOR ANALYSIS	15

5.1.3. RECEIVING VOC ANALYSIS RESULTS	16
5.2. NO2 TUBES	16
5.2.1. RECEIVING NO2 TUBE SHIPMENT	17
5.2.2. SENDING NO2 TUBES BACK FOR ANALYSIS	18
5.2.3. RECEIVING NO2 ANALYSIS RESULTS	18
6. WEIGHING FILTERS	19
6.1. WEIGHING ROOM CONDITIONS	19
6.2. LAB BLANK FILTERS	20
6.3. SAMPLE FILTERS	21
7. CO MONITORS	22
7.1. CALIBRATION GAS BOTTLES	22
7.2. CO MONITOR CALIBRATIONS	22
8. WORKING WITH POPULATION SAMPLE	23
8.1. CUSTOMER'S PATH IN THE EADB	23
8.2. POPULATION SAMPLE	24
8.2.1. P STAT TABLE	24
8.2.2. P NAMES TABLE	25
8.3. MAILED/INTERVIEWED QUESTIONNAIRE	26
9. WORKING WITH CUSTOMERS	27
9.1. CONTACTING CUSTOMERS	27
9.1.1. SELECTING A CUSTOMER	27
9.1.2. CALLING A CUSTOMER	27
10. EXPOSURE MEASUREMENT	29
10.1. SETTING UP THE MEASUREMENT	29
10.1.1. EQUIPMENT IDS FOR THE CUSTOMER	29
10.1.2. SAMPLES FOR THE CUSTOMER	30
10.1.3. FLOWS AND CONDITIONS DURING SETUP	30
10.2. DE AFTER ENDING THE MEASUREMENT	30
10.2.1. FLOWS FOR THE CUSTOMER	30
10.2.2. CUSTOMER μ E CONDITIONS	31
10.2.3. CUSTOMER EQUIPMENT SETUP CONDITIONS	32
10.2.4. EQUIPMENT POSITIONING	32
10.2.5. RUNS FOR SAMPLES	33
11. QUESTIONNAIRES	35
11.1. LONG QUESTIONNAIRE	35
11.2. BASEL HEALTH QUESTIONNAIRE	36
11.3. 48 HOUR QUESTIONNAIRE	36
12. TLAD W/μE TEMPERATURES	37

12.1. CUSTOMER CO FILES	37
12.2. ENTERING TLAD DATA	37
13. CLOSING A CUSTOMER	38
<hr/>	
13.1. CHECKING CUSTOMER DATA	38
13.2. REMOVING PRIVACY PROTECTED DATA	40
14. COMMON QUESTIONS	41
<hr/>	
14.1. THIS AREN'T WORKING, AND I DON'T UNDERSTAND A HECK OF IT	41
14.2. WHY MY CUSTOMER'S DATA IS NOT VISIBLE IN MEASUREMENT FORMS?	41
14.3. WHY THE SAMPLED VOC VOLUME ISN'T SHOWN IN VOC TUBES BACK TO ANALYSIS?	41
14.4. ALL VALUES IN RELATED TABLES ARE ENTERED, AND STILL THE FORM DOES NOT SHOW IT?	41

FIGURES

Figure 2-1. Welcome screen is the swithcboard to open different dataentry forms.	5
Figure 2-2. Database window provides direct access for example to the data tables Other tabs in the tabbed window show for example queries and forms.	6
Figure 3-3. Placing the EADB file on a group disk in directory DATA: Explorer view.....	8
Figure 4-1. The Access Text file import wizard: selecting fields from source data.	13
Figure 5-1. VOC shipments (upper part) and VOC tubes (lower part, the subform) dataentry.....	14
Figure 5-2. This form provides a report of the usage of the tenax tubes for returning the shipment back to the analyzing laboratory. The print-button prints the summary for the selected batch.	15
Figure 5-3. Pasting VOC analysis results from Excel file. PasteErrors button opens Paste Errors table in case of errors.	16
Figure 5-4. Receiving a new NO2 tube batch.	17
Figure 5-5. Sending NO2 tube batch for analysis.	18
Figure 6-1. This form provides dataentry for Weighing room conditions.....	19
Figure 6-2. This form provides dataentry for lab blank filter. The filter is selected from the drop-box up. Filter summary is seen in the upper subform and the filter weighing result series is seen in the lower subform.	20
Figure 6-3. Entering first masses for sample filters.....	21
Figure 6-4. Entering the second masses for filters after sampling. DE form shows only filters with ms but lacking me.	21
Figure 7-5. CO standard gas bottles.	22
Figure 7-6. The Databear calibration events.	22
Figure 8-7. The DE/viewing form for personal status variables in table P Stat.	24
Figure 8-8. The DE/viewing form for personal variables in table P NAMES.....	25
Figure 8-9. The DE/viewing form for Short Questionnaire data.....	26
Figure 9-10. The DE/viewing form for contacting the customer.....	28
Figure 10-11. The DE/viewing form for customer's equipment.	29
Figure 10-12. The DE/viewing form for customer's samples.	30
Figure 10-13. The DE/viewing form for flow measurements.....	31
Figure 10-14. The DE/viewing form for customer microenvironmental conditions measurements.	31
Figure 10-15. The DE/viewing form for setup conditions measurements.	32
Figure 10-16. The DE/viewing form for equipment positioning data.	32
Figure 10-1. Entering runs from the TASK 24: Runs with samples -form.....	33
Figure 10-2. Entering runs from the TASK 24: Runs only -form.	34
Figure 11-3. Entering long questionnaire: the first form of four as an example.....	35
Figure 11-4. Entering 48 hour questionnaire.	36
Figure 12-5. Storing CO download files into directory DATA\CO.	37
Figure 13-6. Checking the customer's data.	39
Figure 13-7. Checking the customer's data.	40

TABLES

<i>Table 3-1. Eid values and typ:s as examples. Serialnr is the manufacturer serial number.</i>	10
<i>Table 3-2. Rid values.</i>	11
<i>Table 8-1. Customer's steps through the EADB and the related control fields.</i>	23

1. Terms, Abbreviations, Conventions and Keys

1.1. General terms

EADB	Expolis Access Database
Access	Microsoft Access version 7
DE	Dataentry
Welcome screen	_ Welcome Form; switchboard to different DE tools in the EADB
Database window	A tabbed window showing all the database objects in the database. Closing Database window closes the database.
Query	A dynamic definition how to collect data from tables. Each time the query is run, the up to date data is retrieved from the tables.
Form	A dataentry view to the data in tables.
Record	A row in a table (contains one or more fields)
Field	A column in a table (parameter)
Null value	No value has been entered; variable is empty. This is the default value for EADB parameters; when a record is created, all values are empty.
Sample	A collected sample; eg. a filter or a tenax tube
Run	Uninterrupted sampling period (from time t_0 to time t_1)

1.2. EADB Key Parameters

The following short parameter names are referred in many places in the EADB. These are key fields that are used to identify data values.

sid	Expolis sample identification code
rid	Expolis researcher identification code
cid	Expolis customer identification code
eid	Expolis equipment identification code

The samples are identified by following codes

env	microenvironment:	I=home in,O=home out,W=work,P=personal
spl	sample	1,2 = filters,V=VOC,N=NO2 6,7 = Grenoble PEM filters (total, indoor) 8,9 = parallel MEM filters, Y-joint
dup	duplicate/blank	1=main sample,2=duplicate,10,20 = blanks

1.3. Document Conventions

The buttons to open different tools in the EADB are shown along the text as figures without a caption.

See example on the right: Setting up measurement.

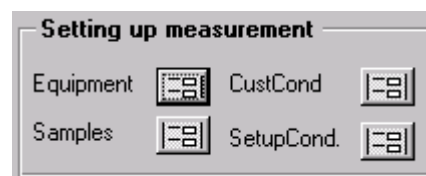

In each relevant chapter the related tables and forms are listed in a table without a caption. See example below: Tables and forms related to contacting a customer. Many forms rely on queries in the EADBTOOL.MDB - these are not listed.

Tables (in local data.MDB)	Forms (in EADBTOOL.MDB)
Econtact	CE Contacting
P Stat	CT Contacting
P NAMES	
P ShortQ	

If the task at hand is a DE task, the data source is also given. See example below: entering sample filter masses. Data source is either a weighing sheet or an Excel file. The DE tools are in most cases for the non-digital data source.

Source: Weighing sheet or Mettler .XLS file	
Tables	Forms
PM Filter samples	PM Sample filter preweighings PM Sample filter afterweighings

Username and buttons in the EADB are printed in bolded **Courier New** font.

Table, query and form names are in bold **Times New Roman**.

References to separate instruction sheets are in ***Times New Roman bold italic***.

1.4. EADB Conventions

-8 Value not applicable (N/A). The answer has no meaning for this record.

-9 Missing value for all fields in EADB is -9

Different causes of missing data are not distinguished (eg. data not measured/asked, value lost/missing, parameter not applicable etc)

Null value marks data not entered. All entered missing data is coded as -9.

Ok-fields What is the usability of the data on the record:

1 = data is ok

2 = there was a slight problem (specify in comment) but data is probably ok

3 = data is not ok

Comment fields Describe the record; make the data 'alive': use comments!
Comment the data on the record.

1.5. EADB Special Keys

The original Access behaviour of F10 function key is to activate the menu. This is overridden in EADB by a macro that opens the Welcome screen. Use alt-key to activate the menu from the keyboard.

Key	Explanation
F10	Open/bring to top the Welcome screen
ctrl-P	Print selected record.

1.6. Access Special Keys

Key	Explanation
ctrl-shift-;	Enter the current date
ctrl-shift-:	Enter the current time
ctrl-'	Copy the value from the previous record
F11	Open/bring to top the database window
ctrl-F	Open Find dialog
ctrl-F6	Switch to the next child window
ctrl-tab	Swich to the next tab on tabbed dialogs
shift-enter	Save edited record
shift-space	Select whole record

1.7. Windows Keys

These key definitions are recommended by Microsoft, but some are not used by all programs. For example, the WordPerfect can be configured to use the older home-home-end for going to the end of the document and to use ctrl-end for deleting the end of current line. The key definitions listed here can all be used in MS-Access.

Key	Alternative	Explanation
ctrl-c	ctrl-ins	Copy the selection to the clipboard
ctrl-x	shift-del	Cut the selection to the clipboard
ctrl-v	shift-ins	Paste the clipboard contents at cursor
ctrl-end		Go to the end of the table (or document)
alt-F4		Close the application (eg. MS-Access)
ctrl-F4		Close the current child window (table, document)
alt		activate the menu

2. Basics of Working with the EADB

This document describes the practical dataentry steps task by task.

Table and parameter definitions are presented in Data structures document. These details are not reproduced here. Please refer to the other document when necessary.

The EADB system consists of three files:

- local data .MDB file contains all local data
- EADBTOOL.MDB file contains all queries and forms
- SECURITY.MDW workgroup file contains permissions for users

The next chapter (chapter 3) explains how to install these files.

2.1. Hardware and Software requirements

The EADB runs on MS-Access version 7, which requires Windows 95 or Windows NT operating system.

The forms have been developed for use in Super VGA resolution (800 x 600 pixels). Mouse or another pointing device is needed. Working with Standard VGA display is possible.

2.2. Users and Administrators

The EADB is secured, as it contains sensitive information.

When you open the EADB, you must log on, using your user account and password. The local data manager will administer the user accounts and give the users instructions how to log on to the EADB.

Default user name is **User** and the default password is empty. The **User** -user has data viewing and dataentry permissions, but lacks permissions to modify the database objects (eg. tables, queries and forms). **User** cannot delete records from the tables. **User** can create new queries and apply filters on them. When using the common **User** account, the password must be shared.

Administrators have all rights on all database objects.

The user accounts are defined in an Access workgroup file. Expolis rights are defined in file SECURITY.MDW. Each workstation must be joined to this file. To do this, activate the WRKGADM.EXE from the local installation directory of Access and press the join button. (See separate instruction sheet: *Joining the Workgroup to Gain Permissions*).

The local data manager (user account **ladmin**), has rights to administer the user accounts. A user account can be created for each individual using the database, or the common account can be used. User accounts are administered using the Access menu Tools - Security - User and Group Accounts (see separate instruction sheet *Access Security - Administering Permissions*.)

The database log records each opening and closing of the EADBTOOL.MDB file using the user account name. To make different users distinguishable from the log, personal accounts must be created for all users.

2.3. Backups

All data is stored on paper files, as described in the SOPs. Thus the paper files provide the last backup resource for the data. To avoid extensive need for data re-entry, the .MDB file should also be backed up now and then. Suitable interval is 2-6 measured customers, for whom the data has been entered into the EADB.

When the data is sent to KTL on a monthly or bimonthly basis, the data is also backed up by KTL.

2.4. Welcome Screen

Welcome screen (form named **_Welcome**) opens automatically, when the EADB file (.MDB file) is opened with Access. On the top of the Welcome screen you must give your researcher id (initials). This rid value is used by several dataentry forms to filter your own customers. Welcome screen insists on having rid entered before you can proceed to other tasks. You can open the database window though to proceed without giving the initials (using menu or keyboard shortcut; not the **Database** button).

The researcher list is base on a table named **A1 Researchers**. By default, it lists all researchers, from all centers. By deleting foreign rid's from **A1 Researchers** table the list can be limited to the local researchers of your center.

NOTE: Do not close Welcome screen when working with EADB. The database log is based on the Welcome screen. If Welcome is closed and then dataentry is continued via the Database window, this is not recorded into the log and it poses a problem in case of a need for EADB recovery from a backup.

When you are finished with EADB, press the **Exit** button in the bottom of the Welcome screen. This closes EADB and Access.

The most common dataentry tasks can be done using forms. These forms are opened when you select the corresponding button on the Welcome screen (look Figure 2-1). Press F10 at any time to open or bring to top the Welcome screen.

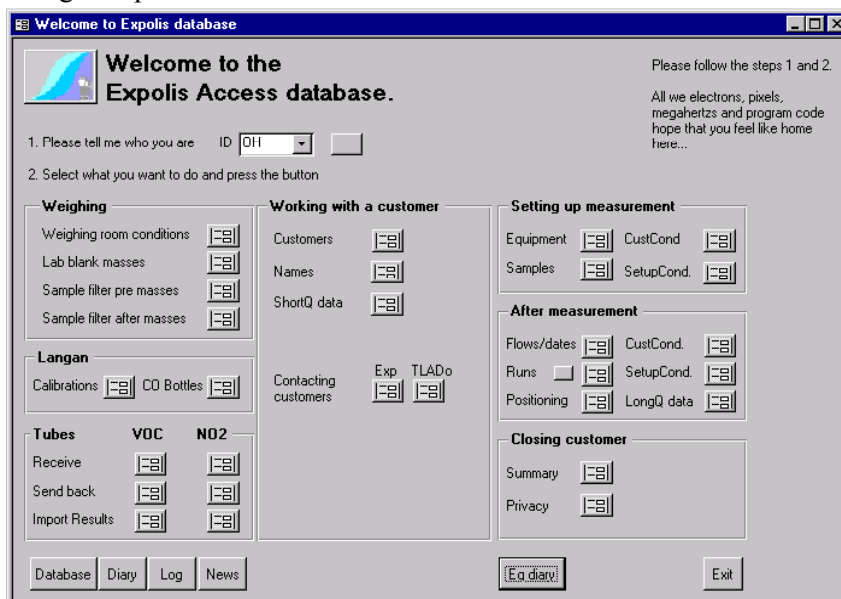

Figure 2-1. Welcome screen is the switchboard to open different dataentry forms.

2.5. Database Window



Most of the time users work with EADB using forms, opening forms from the Welcome screen. Some tasks can be done only using the normal Access table views. If a ready form is not provided for the task at your hand, press the Database button on the bottom of the Welcome screen to open the Database window

Database window can be opened any time by pressing F11, or selecting File - 1 from the menu, or by using Window menu Unhide command. Function key F11 is the handiest way.

From the Database window you can select Table, Query and Form tabs. From these you can open the corresponding database objects. In a simple dataentry/data management task you can open the data table and work directly with it. (Look Figure 2-2).

When the Database window is closed, the database closes too.

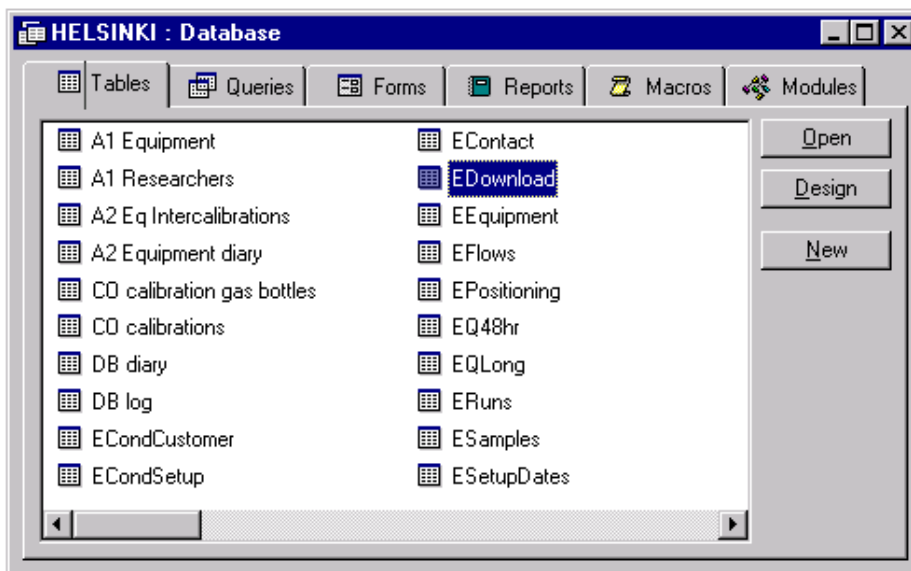

Figure 2-2. Database window provides direct access for example to the data tables Other tabs in the tabbed window show for example queries and forms.

2.6. Forms and Queries

The EADB contains tens of queries and forms that are used to manage the information in the database. Queries select and combine data from the tables. Forms are used as dataentry and data viewing tools. Some of the provided forms rely on queries, some define queries of their own (stored within the form). The standard EADB queries must not be renamed or deleted to keep the forms functional.

When working with the EADB, a need may raise to make new queries, and even forms. Because extensive numbers of these custom queries and forms can be generated, they must be named with care. Names are sorted alphabetically.

In many cases new queries can be created only temporarily - not saving them after use. When you create a query that will be used again, you can save it, giving it a name. Recommended style is to use your initials or forename as the beginning of the query or form name, like "NN: smoking customers".

2.7. Database diary

The table **DB Diary** can be used to record changes and other operations made to/with the EADB database. A form with the same name can be opened from the **Welcome** screen using the button **Diary**.



At least all local modifications to tables, queries and forms should be registered into the diary.

2.8. Database log

The table **DB log** keeps automatically record of times when the **Welcome** screen is open by a user. The user name is recorded to this table, along with the opening and closing time of the **Welcome** screen. If several persons do dataentry to the database, it is recommended to create a separate user account for each user. If common account is used, the log will show only the common user name and the true user must be tracked otherwise.

The **DB log** table is the only table that is local to the EADBTOOL.MDB file. If several EADBTOOL.MDB files are used, then each of these will have a log file of its own.

The log can be used to track re-entry needs after recovering from a database failure. If the database closes abnormally, the end date entry will be null. The log can be opened from the **Welcome** screen using the button **Log**.

2.9. The News file

A text file named NEWS.TXT can be used to transfer information between different users of the EADB and the local administrator. The text file should be located in the same directory as the EADB file (in directory \DATA).

The news file can be opened from the **Welcome** screen using the button **News**.

The location of the \DATA directory must be specified in the module **ExpolisModule1**. This should be done once by the local database administrator to activate the **News** button.

Following is the code section from the beginning of the module where the EADB directory location is specified. In Helsinki this directory is G:\DATA; replace the G:\DATA with the local directory drive and path.

```
' Replace the location of the database file here  
Public Const Folder As String = "G:\DATA\"
```

2.10. Equipment diary

The table **A2 Equipment Diary** is used to record all operations made to the equipment. A form with the same name can be opened from the **Welcome** screen using the button **EqDiary**.

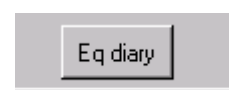

Normal flow calibration checks can be left out the diary, but all other operations should be marked.

3. Making the local EADB functional

The local database must be prepared for use before the data can be entered into it.

3.1. Placing the .MDB file on a Disk

The .MDB file will be placed into a directory called DATA. Other Expolis data files will be placed into subdirectories of this directory.

If the EADB needs to be accessed from several computers, the DATA directory must be on a shared disk.

The Access workgroup file SECURITY.MDW is placed into the same directory as the .MDB file.

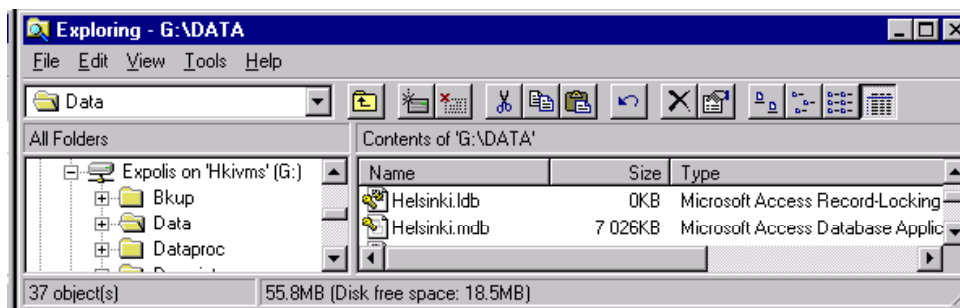

Figure 3-3. Placing the EADB file on a group disk in directory DATA: Explorer view.

3.1.1. EADB Installation steps

Following steps are needed to install the files from the distribution diskettes. The screen printouts are presented in separate instruction sheet *Seven simple steps to the EADB*.

1. Create the Destination Directory

Use EXPLORER to create a directory called DATA. Place the directory as you like in the directory tree.

2. Unzip the Files from the Diskettes

Copy the file A:UNZIP.BAT from the diskette to the DATA directory (created in step 1 or earlier).

Start the UNZIP.BAT file from the DATA directory by double clicking it in EXPLORER.

3. Join to the Expolis Security Workgroup

This step must be once for each workstation (Access installation) using the EADB.

Use WRKGADM.EXE which is located in the directory where Access is installed in your machine. Start it with EXPLORER, select JOIN button, browse to the DATA directory and select to open the SECURITY.MDW file.

Press OK a couple of times and then EXIT button.

4. Open the Access and Log On

Start Access (eg. From the Start menu).

First time log on as **ladmin** to have rights to administer the table links.

5. Open the Tool Database EADBTOOL.MDB

In the Access, from the File menu select Open, and browse to the DATA directory and open the EADBTOOL.MDB.

This is the file to open when using EADB. You can create a shortcut to this file on the Windows 95 or Windows NT desktop.

6. Link to the Tables in Your Local Data file

From the Access menu select Tools - Security - Linked Table Manager.

From the dialog select Select all, and check the Always prompt for new location. Press ok.
From the next dialog select the local data.MDB file (eg. In Athens ATHENS.MDB) and press ok.

This step must be repeated for each copy of EADBTOOLMDB file that is in use. Also, if the location of the local data.MDB file is changed (eg. in network), this step must be repeated.

7. Use Your Database

Create any user accounts you need while logged on as **ladmin**. (see separate instruction sheet *Administering user accounts and permissions*).

Exit Access. Next time logon as **User**, or what ever usernames you created.

3.2. Lookup Tables

Some tables in the database are used as lookup tables to provide legal values for other tables. These lookup tables must be filled in before the database becomes functional. Two most important lookup tables are **A1 Researcher** and **A1 Equipment** tables.

It is worthwhile to mention that the relations between the tables make it necessary to add new data into the database in a logical order. For example each sample must be registered into the EADB before results for that sample can be imported. To keep the EADB functioning properly, follow the sequence of this documentation in your DE tasks.

3.2.1. Table A1 Equipment

This table lists the equipment used in each center. The equipment are numbered with short Expolis numbers, using number spaces defined for each center. In this table the short Expolis equipment number is connected to the manufacturer serial numbers. The beginning of each equipment id identifies the equipment type.

The eid begins with letters identifying the equipment type and continues with a number. This number begins with the center number (H= 0 or 1, A=2, B=3, G=4, M=5, P=6). The last digit identifies the piece of equipment in each center.

The typ values must also follow exactly the values shown in following table.

Table 3-1. Eid values and typ:s as examples. Serialnr is the manufacturer serial number.

eid	serialnr	Typ	Comment
BAL01		Balance	
BA01		BATTERY FRAME	
A01		BOX	*
B01		BUCK	*
C01		CASE	*
CH01		CHARGER	
CY01		CYCLONE	*
E01		EPA WINS	*
F01		FILTER HOLDER	*
L01		LANGAN	*
AP01		Manometer	*
RH01		OTHER	*
P01		PQ100	*
T01		TRIPOD FRAME	
TC01		TSP cap	
W01		WATER JAR	
Y01		Y-JOINT	

Table **A2 Equipment diary** is used to record information about the equipment. All non routine operations should be recorded in this table. Records that have '*' in comment column are necessary; they are used in several drop down list boxes in DE forms.

3.2.2. Table A1 Researchers

The researcher id (rid) value is used to identify persons. This table provides the legal values for the rid fields in several other tables and connects the initials to the person's name.

The rid is preferably the persons initials, but we should assure that the rid values are unique across all the centers.

The following table lists rid values in the EADB delivery version 21.3.1997. The researchers from other centers can be deleted from a local database. International database will contain all researcher codes.

Table 3-2. Rid values.

rid	Name
H	
AK	Anu Kousa
AMP	Anna-Maija Piippo
JJ	Jouni Jurvelin
KK	Kimmo Koistinen
OH	Otto Hänninen
SA	Sari Alm
TH	Tirre Halonen
TR	Tuulia Rotko
TS	Tuija Stambej
VT	Virpi Tenhola
A	
LG	Lambros Georgoulis
MC	Maria Caparis
ES	Evi Samoli
B	
LO	Lucy Oglesby
G	
CB	Celine Boudet
M	
DC	Domenico Cavallo
PC	Paolo Carrer
P	
LP	Libuse Polanska
ET	Eva Tischerova

4. Importing Digital Data

Most of the dataentry described in this document is done manually typing the values from a paper data source. When possible, it is much more efficient to import data already in digital form. This is the case for example when importing population sample data from the Civil Register or other digital register data source.

This chapter briefly describes how digital data can be imported into the EADB.

4.1. *Transforming Variables*

The variables (fields in different tables) in the EADB have a defined coding and format. When data is imported from other digital sources, the coding differences must be listed and a data transform plan must be made.

The data transformation from one type of coding to the EADB coding can be done either in the data source system, like Excel, SPSS etc. before the data transfer, or it can be done in EADB after data has been imported.

4.2. *Importing Data from Excel*

Data from sources with table format, like data from spreadsheet programs can easily be imported into EADB using the Windows clipboard.

In this case the data must be transformed to the EADB format before the data transfer. Values can be imported into one table in the EADB at a time. The columns in the Excel file must be in the same order as the fields in the destination table in the EADB, and the variables must have identical coding as the EADB variables.

When the values in the Excel table have been coded properly and the column order has been set to the EADB field order, the data area to be transferred is selected and copied into the clipboard.

Then the EADB destination table is opened and from the Edit menu the Paste Append command is selected. The selected data is then appended to the EADB table.

4.2.1. Paste Errors table

When Paste Appending data, some rows of data might contain missing or illegal values for the destination table. In this case Access places the data lines that could not be appended to the destination table into the table named **Paste Errors**.

The **Paste Errors** table is created by Access, if it did not exist. By default the fields in Access created Paste Errors table are of Memo type. This data type cannot be further Paste Appended to destination tables, if the destination field is not also a Memo.

This problem can be circumvented by using a specifically formatted **Paste Errors** table for each data transfer operation type. If the Memo fields are changed to Text type, then data can be further

paste, even for numerical fields. To save a specifically formatted **Paste Errors** table, it must be renamed or copied under another name, like **Paste Errors for VOC import**.

4.3. Importing data using ASCII files

Access has very powerful file import filters. Available filters include ASCII, spreadsheet and database formats.

The file import procedure is activated from File menu - Get External Data - Import files command. From the same menu you can also link the database to external data; in this case the data stays external, but you can use it directly from the Access database.

The preferred import procedure is to import the file as a new table in the EADB. The data from this temporary table is then copied (via clipboard) to the destination EADB table, if the table structure and the variable coding are identical. If this is not the case, an update query must be used to update fields in destination table selectively, with possibly needed data coding transformations.

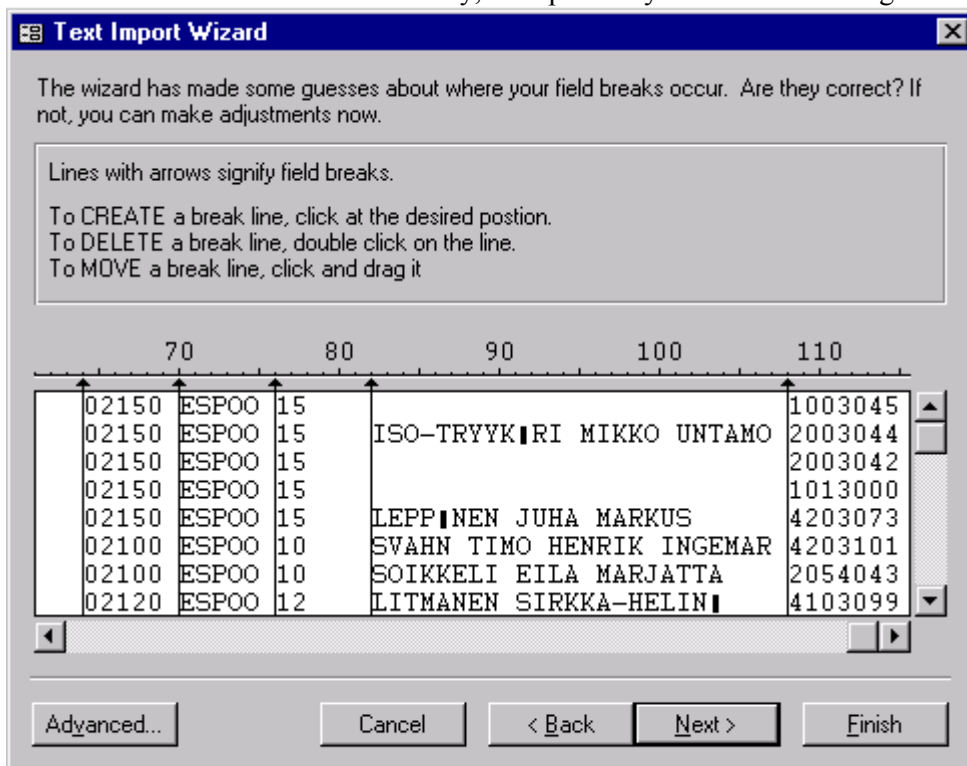

Figure 4-1. The Access Text file import wizard: selecting fields from source data.

4.4. Checking Data after Transfer

Data should be intensively checked after any larger data transfer operations to make sure that all fields have been transferred correctly and that variable coding in destination table follows the EADB definitions.

5. VOC and NO2 sampling tubes

This section describes the handling of VOC and NO2 sampling tubes and results.

Tubes are processed in batches. When tubes are received, the tube numbers are marked into the EADB. When tubes are sent for analysis, a sampling report is printed to be sent to the lab with the tubes. When the laboratory sends the analysis results, they are appended to the EADB.

Tubes	VOC	NO2
Receive		
Send back		
Import Results		

5.1. VOC Tubes

Tables	Forms
VOC compounds	
VOC shipments	VOC tubes back to analysis (w/sub)
VOC tubes	VOC receive tube shipment (w/sub)
VOC masses	VOC Receive results (w/sub)

5.1.1. Receiving VOC Tube Shipment

Source: VOC sid list, tube codes on the tubes	
Tables	Forms
VOC shipments	VOC receive tube shipment (w/sub)
VOC tubes	--

When VOC tubes are received from the laboratory (eg. VTT), they are accompanied by a list of Expolis sample numbers (sid). The tenax tubes have also a stanssed code on them.

The shipments are numbered using a number space of each center. The first shipment in Athens is 201 (replace 2 with the number of your center), second is 202 and so on.

Batch	VOCnr	tubecode
30	116622	A29006
30	118107	A53606
30	137808	A48999
30	143253	A20548
30	147609	A53580
30	167805	A50026
30	175032	A03000

Figure 5-1. VOC shipments (upper part) and VOC tubes (lower part, the subform) dataentry.

First step is to add the VOC tube shipment into the **VOC shipments** table using the upper part of the form.

Then the sids are paired with the tenax tube codes in the **VOC tubes** table using the subform in the lower part of the main DE form.

5.1.2. Sending VOC Tubes Back for Analysis

Tables	Forms
VOC shipments	VOC tubes back to analysis (w/sub)
VOC tubes	
Econtact	
Esamples	
Eruns	

The return date is entered into the **VOC shipments** table using the forms upper part.

A report is printed with the tube usage. The **Print** button on the form prints out the selected tube batch. Using the form and/or the printout, the data is checked.

batc	sid	tube	cid	rid	Comment	env	dup	dur	Vpf	Vaf	V
28	105732	A35818		AK		W	10				
28	137313	A11654	2611	VT		P	1	46.7	0.692	0.714	1.968
28	140580	A34255	2607	JJ		I	1	30.0	2.334	1.894	3.805
28	146916	A20811	2611	VT		I	1	26.0	2.297	2.955	4.097
28	162657	W1181	2604	TR		P	1	42.3	0.845	0.94	2.267
28	169785	A31357	2607	JJ		O	1	30.0	2.399	2.452	4.366

Figure 5-2. This form provides a report of the usage of the tenax tubes for returning the shipment back to the analyzing laboratory. The print-button prints the summary for the selected batch.

Besides the **Print** button is **Edit** button, which opens **VOC tube edit** form. This form can be used to edit the tube comments, which is locked on the current form. For example not used tubes should be marked.

5.1.3. Receiving VOC Analysis Results

Source: VOC result file in Excel format	
Tables	Forms
VOC masses	VOC Receive results (w/sub)

The VOC masses are painted in Excel and copied into clipboard.

Then they are Paste-Appended into the **VOC masses** table (using corresponding form).

In case of an paste error, the erroneus records are placed on a table named **Paste Errors**. Normal errors have been having the result for same compound (CAS number) for the same sample twice, and missing the standard field value (PS/T). The faulty records can be pasted from Paste Errors to the VOC masses table after the errors have been corrected, if the specifically formatted version of Paste Errors table is used. To use this table, copy table **Paste Errors for VOC import to Paste Errors**.

The import form has a button to directly open the **Paste Errors** table after Paste Append.

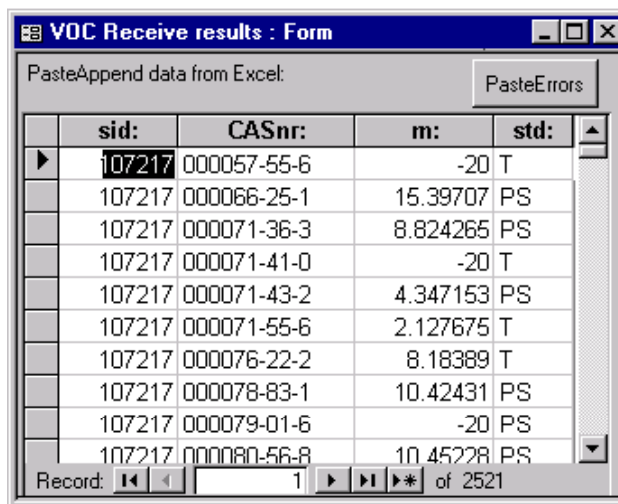

Figure 5-3. Pasting VOC analysis results from Excel file. PasteErrors button opens Paste Errors table in case of errors.

5.2. NO2 Tubes

Tables	Forms
NO2 shipments	NO2 tubes back to analysis (w/sub)
NO2 tubes	NO2 receive tube shipment (w/sub)
NO2 results	NO2 Receive results (w/sub)

NO2 tube processing is similar to the VOC tube processing, although slightly simpler.

5.2.1. Receiving NO2 tube shipment

Source: NO2 sid list	
Tables	Forms
NO2 shipments	NO2 receive tube shipment (w/sub)
NO2 tubes	

When NO2 tube batch is received from the laboratory (eg. Basel), it is added to the **NO2 tube shipment** table. Shipments are numbered and the arrival date is entered. The shipments are numbered using a number space of each center. The first shipment in Athens is 201 (replace 2 with the number of your center), second is 202 and so on.

The tubes are given sids from the local NO2 sid number list. Used numbers are marked on the list. Then the sids are entered into the **NO2 tubes** table.

Blank tubes are marked with **blnk** code (1=lab blank, 2=shipment blank). The absorbance of the lab blanks is used in the concentration calculation. Shipment blanks are used to control for contamination during shipping.

Figure 5-4. Receiving a new NO2 tube batch.

5.2.2. Sending NO2 tubes back for analysis

Tables	Forms
NO2 shipments	NO2 tubes back to analysis (w/sub)
NO2 tubes	
Econtact	
Esamples	
Eruns	

The return date is entered into the tube shipments table.

A report is printed with the tube usage information. The **Print** button on the form prints out the selected shipment page(s).

Batch	sid	cid	rid	Comment	env	dup	dur	abs	level
3	124155								
3	124248	2159	VT		P	1			
3	124341								
3	124434	2159	VT		I	1			
3	124527	673	TS		P	1			
3	124620								
3	124713								
3	124806								
3	124899	2159	VT		O	1			
3	124992	2159	VT		O	1			
3	125085	2159	VT		I	2			
3	125178								

Figure 5-5. Sending NO2 tube batch for analysis.

5.2.3. Receiving NO2 analysis results

Source: NO2 result listing	
Tables	Forms
NO2 Results	NO2 Receive results (w/sub)

NO2 absorbances are typed into the corresponding form as they cannot be provided digitally by the analysing laboratory.

The EADB calculates the concentrations using run times, sample absorbancies and the laboratory blank tube absorbancies.

6. Weighing Filters

Filters are divided into two classes: sample filters, which are weighed twice (before and after sampling) and lab blank filters, which are weighed multiple times. The results of these two filter groups are stored in two different tables.

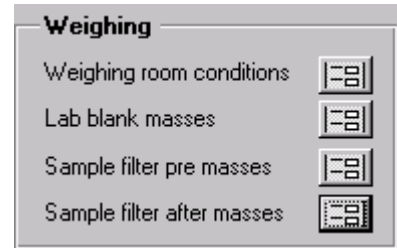

The daily weighing room conditions are also stored.

6.1. Weighing Room Conditions

Source: Weighing sheet or Mettler .XLS file	
Tables	Forms
PM Weighing room conditions	PM Weighing room conditions

Weighing room conditions are entered into the corresponding table. For each parameter, also the equipment id (eid) of the used device is entered.

Temperature is entered in °C

Relative humidity is entered in %

Air pressure is entered in mmHg

Sdate	ID	rhs	rhm	Ts	Tm	Ps	Pm	Comment
13.01.97 15:24	ts	18.8	rh1	20.3	rh1	754	ap02	
14.01.97 09:14	ts	23.9	rh1	19.9	rh1	750	ap02	
14.01.97 10:56	ts	22.6	rh1	20.1	rh1	752	ap02	
16.01.97 13:04	TS	20.2	RH01	20.3	RH01	760	AP02	
16.01.97 14:04	TS	20	RH01	20.2	RH01	760	AP02	

Figure 6-1. This form provides dataentry for Weighing room conditions.

6.2. Lab Blank Filters

Source: Weighing sheet or Mettler .XLS file	
Tables	Forms
PM Filter lab blanks	PM Lab blanks (w/sub, summary)

Blank filter table contains only one mass per row (record). Each filter number can be entered several times into this table. To differentiate the different weighings, a weighing count is entered.

The standard weight is given a sid value, which is reserved for it only.

All the daily/weekly laboratory blank filter weighing results are entered into this table.

PM Lab blanks : Form

Type in/Select the filter: Filternr:

TASK 61: Lab blanks summary

Filternr: Days:

1.st weighing: Count:

Last weighing: As sample:

TASK 61: Lab blanks subform

Filternr	cnt	Sdate	ms	id	ok	Comment	Testcod
990099	1	12.8.1996	200.007		0		
990099	2	12.8.1996	200.005		0		
990099	3	12.8.1996	200.012		0		
990099	4	12.8.1996	200.002		0		
990099	5	13.8.1996	199.999		0		
990099	6	13.8.1996	199.998		0		
990099	7	13.8.1996	200.007		0		
990099	8	13.8.1996	200.001		0		
990099	9	14.8.1996	200.014		0		
990099	10	14.8.1996	200.011		0		
990099	11	14.8.1996	200.007		0		
990099	12	14.8.1996	200.007		0		
990099	13	15.8.1996	200.005		0		
990099	14	15.8.1996	200.004		0		

Record: of 412

Figure 6-2. This form provides dataentry for lab blank filter. The filter is selected from the drop-box up. Filter summary is seen in the upper subform and the filter weighing result series is seen in the lower subform.

6.3. Sample Filters

Source: Weighing sheet or Mettler .XLS file	
Tables	Forms
PM Filter samples	PM Sample filter preweighings PM Sample filter afterweighings

Sample filters do have only one record per filter. Each record contains both the mass before sampling as well as mass after sampling.

The preweighing dataentry form shows no previous results. It shows only the needed fields for the preweighing.

Figure 6-3. Entering first masses for sample filters.

The after weighing dataentry form shows only records that have the start mass but lack the end mass.

	sid	Sdate	ms	ids	Edate	me	ide	diff	Comment	ok
▶	825660	06.02.97 10.25	130.049	kk					reikä ei käyttöön	2
	935946	19.12.96 09.47	134.385	JJ	08.01.97 00.00		AK		broken	3
	861498	19.12.96 08.53	129.869	JJ						
	943866	05.12.96 14.30	131.209	VT						

Figure 6-4. Entering the second masses for filters after sampling. DE form shows only filters with ms but lacking me.

Weighing data can also be imported from a Excel worksheet to the EADB. In this case the data is Paste Apped:ed directly to the corresponding table.

Look for **Paste Errors** -table in case of errors. Use a formatted version of **Paste Errors** table, if you want to be able to Cut and PasteAppend the values after corrections to the data table.

7. CO Monitors

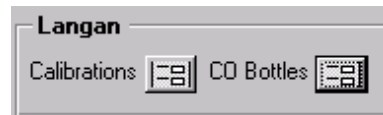

The CO monitors (Databears) produce detailed 1 minute data of temperature and CO concentration. This data is downloaded into customer specific files, named with the cid value, and the files are stored separately.

The databear calibration information is stored in EADB.

7.1. Calibration Gas Bottles

Source: Calibration gas bottle analysis sheet	
Tables	Forms
CO calibration gas bottles	CO calibration gas bottles

The calibration gas bottles are entered into this table. The bottles are numbered using a number space of each center. The first (and maybe only) bottle in Athens is 21 (replace 2 with the number of your center), second is 22 and so on.

The concentration and accuracy values are given in ppm.

counter	date	conc	acc	rid
1	7.3.1996	29.2	0.6	SA
2		10.0	0.1	SA

Figure 7-5. CO standard gas bottles.

7.2. CO Monitor Calibrations

Source: CO Monitor calibration sheet	
Tables	Forms
CO calibrations	CO calibrations

Each CO monitor calibration event is recorded into this table. The zero and calibration displays of the Databear are recorded in ppm.

eid	Date	bottle	zero	cal	rid
L03	28.08.96	1	0.02	31.8	AK
L03	30.08.96	1	0.02	31.3	AK
L01	30.08.96	1	0.34	31.1	AK
L01	10.09.96	1	0.27	31	TR
L01	12.09.96	1	0.34	30.1	TS
L04	17.09.96	1	0.15	29.55	TS

Figure 7-6. The Databear calibration events.

8. Working with Population Sample

This chapter describes the population sample and subsamples.

Also a customer's steps in the EADB during the measurement procedures are described here.

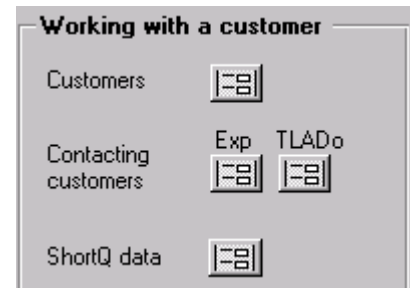

8.1. Customer's Path in the EADB

Customers in the EADB fall into different classes. Some of the customers browse through the measurement cycle, which is controlled by several status variables in the EADB. These status variables are listed with the customer's steps in following table.

Table 8-1. Customer's steps through the EADB and the related control fields.

Step	Control field	Values
Person is drawn into the population sample	P Stat.cid	A cid value is assigned to the person from the International number spaces; an unique number for each person
Person answers the mailed or interviewed short questionnaire	P Stat.answer P ShortQ.adata	Answer classes a,b,...# Answer date
Person is drawn into a measurement sample	P Stat.select	A select code is assigned: 2000-2999: exposure 3000-3999: TALD only
Customer is selected for measurement	P Stat.rid	Researcher's initials: researcher responsible for this customer
Measurement is agreed upon	P Stat.stat	According to customers's response: y=yes n=no (disagreed on contact) m=measured d=dropped (not suitable) l=later yg=yes, TLADo group mg=yes, TLADo group mm=yes, TLADo mailed

Most of the control fields are used to filter out not willing persons from the measurement samples. The last control field, stat is then used to trace the customer's current status during the measurement.

8.2. Population Sample

Source: Civil Register file, Mailed Questionnaire answers	
Tables	Forms
P Stat	CA Stat
P NAMES	CA NAMES, CB Privacy
P ShortQ	PShortQ

The population sample is created by assigning cid values to 1000 - 3000 persons drawn randomly from the population. The cid values are given from the International number space for each center.

The population sample can be imported into EADB in digital format, or the basic values can be typed into the database using DE forms.

8.2.1. P Stat table

The basis for processing a customer in EADB is the **P Stat** table. When entering a new customer into the EADB, the first step is to enter the customer into the P Stat table.

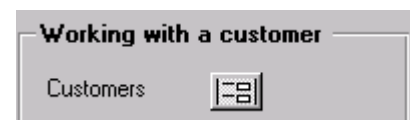

P Stat table contains the cid values (from the international number spaces defined in Expolis Data Specifications).

This table can be accessed using the **CA Stat** form. CA stands for Customers - All.

Figure 8-7. The DE/viewing form for personal status variables in table P Stat.

The customer status form **CA Stat** can be used to enter the customers into the EADB and to update the status variables after answer the short questionnaire.

The form can be used also after drawing the subsamples for measurement groups, but preferably this should be done digitally.

8.2.2. P NAMES table



The personal information of the customers is stored in table P NAMES. This table can be accessed using the **Names** button on form **CA Names**.

Privacy protected data is marked with blue color on the **CA Names** form. All privacy protected data of a customer is stored on this table.

The form **CA Names** shows also the customer's status variables from the **P Stat** table in the upper part of the form.

Figure 8-8. The DE/viewing form for personal variables in table P NAMES.

The **CA Names** form can be used to enter the customer data into the database if the data is not available in digital form. Importing the data digitally into EADB is the preferable method.

8.3. Mailed/Interviewed Questionnaire

ShortQ data



Source: Mailed Questionnaire answers	
Tables	Forms
P ShortQ	PShortQ

The civil register and mailed questionnaire parameters are stored into **P ShortQ** table. This table contains fields for every variable having a value from these data sources in any of the Expolis centers. Thus, in every center, there will be some missing values in the **P ShortQ** table.

The data into the **P ShortQ** table is entered with the **PShortQ** form, which can be opened from the Welcome screen or from several other questionnaire related forms using **ShortQ** button.

The variable coding is shown on the Access status bar (see the bottom of Access window). Also, classified variables normally have a list box listing the available values with explanations.

Classified variables must be entered very carefully into the EADB, as classification error cannot be detected from the data later, and consecutive classes do have totally different meanings.

The screenshot shows the 'PShortQ : Form' window with the following fields and values:

- cid: []
- psok: []
- adate: 31.5.1996
- comment: []
- Basic parameters:
 - sex: -9
 - birthyr: -9
 - eduyr: 12
 - eduyrc: 1
 - wplace: -9
 - wplacet: []
 - adults: -9
 - children: -9
 - hrout: []
 - hlocB: []
 - htraffic: []
 - wheez: []
 - astma: []
 - nasal: []
 - ssmoke: -9
 - particip: -9
- Commuting:
 - SWalkt: []
 - WWalkt: []
 - SMotot: []
 - WMotot: []
 - SCart: []
 - WCart: []
 - SBust: []
 - WBust: []
 - STraint: []
 - WTraint: []
 - WWalkd: []
 - WMotod: []
 - WCard: []
 - WBust: []
 - WTraind: []
- Optional parameters:
 - marital: -9
 - occup: -9
 - occupat: []
 - occupat: Not given
 - sens: -9
 - nat: []
 - harea: -9
 - htype: -9
 - hsmoke: -9
 - stove: -9
 - wloc: -9
 - occupcl: []
 - eduAth: []

Buttons at the bottom: Stat, Names, ShortQ, LongQ, 48hQ. Record: 1 of 2533.

Figure 8-9. The DE/viewing form for Short Questionnaire data.

9. Working with Customers

Contacting the customers is described in this chapter. The measurement procedures are described in the next chapter.

9.1. Contacting Customers

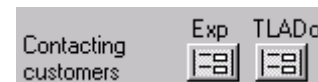

The two forms for contacting the customers selectively process only exposure measurement (**CE Contacting**) or TLAD only (**CT Contacting**) subsamples.

Source: CE Contacting printout, filled during the phone contact	
Tables	Forms
Econtact	CE Contacting
P Stat	CT Contacting
P NAMES	
P ShortQ	

9.1.1. Selecting a Customer

The customers in each measurement group are processed approximately in the order of the select code. Thus the customers will be processed in random order through out the measurement period.

The customer for next contact trial is selected from the database using the **CE Contacting** (exposure measurement customers) and **CT Contacting** (TLADo customer) forms.

The customer is selected from the list using PGUP/PGDN keys. The rid is set to mark the customer as selected. The form is printed using the **Print** button. The print is used during the telephone/other contact.

9.1.2. Calling a customer

During the phone call information on P Names and EContact tables must be updated. This information is marked on the paper print during phone call and entered into the EADB afterwards.

According to the customer's response his/her status is marked as

- y = yes, measurement agreed
- n = customer disagreed measurement
- l = measurement will be possible later
- d = this customer had to be dropped (not suitable)

Work place information is coded and the starting and visiting dates are set.

The working hours are asked for to facilitate the pump run programming.

The balcony or protected yard are asked for to find out if the measurement outdoors is possible. The mains power availability is checked to be sure to have charged pumps, when mains power is not available.

The screenshot shows a web-based form titled "CE Contacting : Form". The form is organized into several sections:

- P Stat:** Contains fields for "cid", "select" (with a dropdown menu showing "2000"), and "comment". Below these are "answer" (with a dropdown menu showing "a"), "stat" (with a dropdown menu showing "y"), and "rid" (with a dropdown menu showing "OH"). There are also "Filters" buttons for "My", "Blk", and "All", and a "Print this page" button.
- P NAMES:** This section contains multiple fields for contact information, including "hphone", "wphone", "street", "streetnr", "zip", "city", "cityq", "staco", "pnok", "name", "fname", "spouse", "wstreet", "wstreetnr", "wzip", "wcity", "wcityq", and "wstaco". A blue link "Blue: privacy protected data" is visible. A "Goto Form" section contains buttons for "Stat", "ShortQ", "Names", "LongQ", "Welco", and "48hQ".
- EContact:** Contains fields for "Sdate", "VdateH", "VdateW", "Whours1", "Edate", "EdateW", and "Whours2", along with a "comment" field.

At the bottom of the form, there is a "Record:" label followed by navigation icons and the text "5 of 7 (Filtered)".

Figure 9-10. The DE/viewing form for contacting the customer.

10. Exposure Measurement

This section describes how to enter the measurement data to the EADB manually.

The customer measurement procedure is divided into three parts:

- setting up the measurement
- entering data after ending the measurement
- checking the customer's data

10.1. Setting up the Measurement

This section describes DE that can be done after setting up the customer measurement.

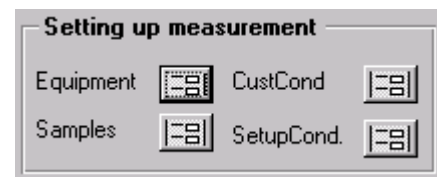

10.1.1. Equipment ids for the Customer



Source: MEM and PEM sheets	
Tables	Forms
EEquipment	TASK 22: Equipment (w/sub)

The **EEquipment** table identifies the equipment used in a customer measurement. The equipment information is quite detailed to make it possible to trace back data related to a certain piece of equipment.

Equipment are identified by eid codes, which are set in table **A1 Equipment**. Customer's each microenvironment and duplicate is entered.

cid	env	dup	pump	set	la/fh	cy/im	chargec	ok	comment
-9	O	1	P02	S05	F02		<input checked="" type="checkbox"/>	1	Form Test entry
-9	P	1	B01	C01	L01	CY01	<input type="checkbox"/>	1	Form Test entry
-9							<input type="checkbox"/>		

Figure 10-11. The DE/viewing form for customer's equipment.

10.1.2.Samples for the Customer



Source: MEM and PEM sheets, NO2 sheet	
Tables	Forms
ESamples	TASK 22: Samples (w/sub)

All samples are identified with the sid code. All the customer’s samples are connected to the measurement microenvironment in **ESamples** table.

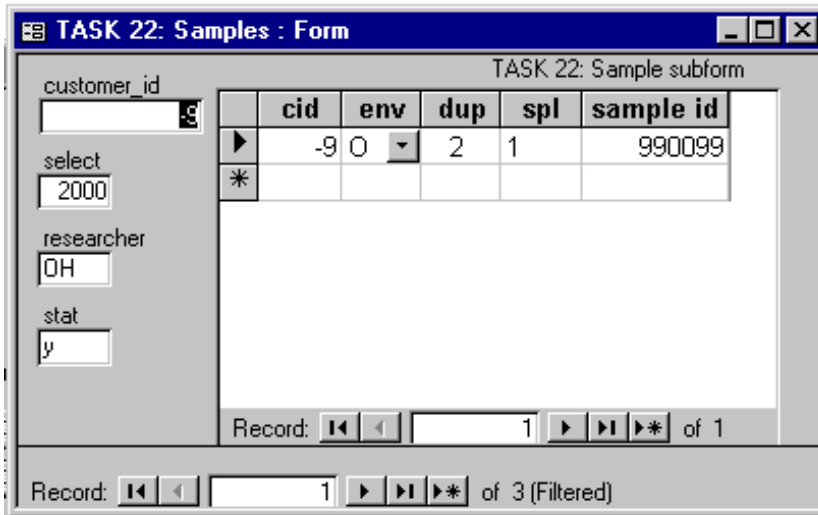
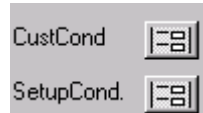

Figure 10-12. The DE/viewing form for customer’s samples.

10.1.3.Flows and Conditions during Setup



The flow measurements during equipment setup as well as the setup conditions in laboratory and in customer microenvironments are registered and can be entered during the first stage of the customer measurement dataentry. As these forms are exactly the same as the ones used for entering the same results for ending measurement, the dataentry is described only once in following chapter.

10.2. DE after Ending the Measurement

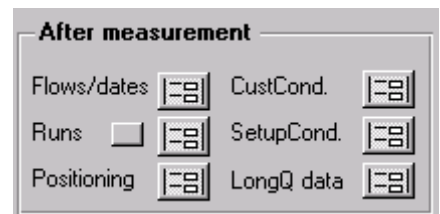

This section describes DE steps after the customer measurement has ended.

10.2.1.Flows for the Customer

Source: MEM and PEM sheets	
Tables	Forms
Eflows	TASK 23: Flows all (w/Flows both datasheet)
ESetupDates	

The flow measurements before and after the customer measurement are entered into the flow table. The setup dates are entered into the **ESetupDates** table to make it possible to connect the flow measurements to the setup conditions.

The setup dates are entered from the same form as the flow measurements.

cid	env	dup	pre	Vpf	after	ok	Vaf	Vok	Vpem	comment
632	I	1	16.5	2.04	17.5	1	2.27	1		
632	O	1	16.9	1.83	16.6	1	2.08	1		
632	P	1	4.132	0.827	4.055	1	0.801	1	11.138	
632	W	1	16.9	2.65	16.9	1	2.9	1		
632	W	2	16.9	2.43	17.05	1	2.64	1		

Figure 10-13. The DE/viewing form for flow measurements.

For each equipment setup both the filter as well as the VOC line flow result is entered. Note that both of these flow measurements do have their own Ok-field. In case of flow problems use the comment field.

For PEM measurement, enter the total sample volume reported by the Buck pump here. For MEM measurements the pump volume is entered into the **ERuns** table, as PQ100 reports the volume separately for each run.

10.2.2. Customer μ E Conditions

CustCond.

Source: MEM sheets	
Tables	Forms
ECondCustomer	ECondCustomer

This table contains the temperature and relative humidity data from the customer's indoor microenvironments.

cid	env	cnt	rh	rhm	T	Tm	ccok	Comment
2604	I	2	26.7	RH08	20.7		1	
2604	W	1	25.7	RH08	19.6	RH08	1	
2604	W	2	26.8	RH08	21.0		1	

Figure 10-14. The DE/viewing form for customer microenvironmental conditions measurements.

Enter 1 for cnt for setup values and 2 for ending values. Identify the used meters with eid codes.

The customer visit dates in the **EContact** table are used to identify the measurement time; if the visits were not as planned, edit the values in **EContact** table (using **CE Contacting** form).

10.2.3. Customer Equipment Setup Conditions

SetupCond.

Tables	Forms
ECondSetup	ECondSetup

The setup conditions in this table are used to normalize the flow measurements according to the observed pressure and temperature. This table identifies the measurement by date. It is assumed that all setup on that particulate day were done in the same room/same conditions.

The flow measurement dates are entered into **ESetupDates** table using **Eflows** form. Be sure to use the same date/time value for the **ESetupDates** entry and the entry in the **ECondSetup** table.

Sdate	ID	rh	rhm	T	Tm	P	Pm	scok	Comment
07.03.97 19:00	TS	21.3	RH04	21.6	RH04	771	AP02	1	
12.03.97 10:00	TS	20.3	RH04	20.8	RH04	768	AP02	1	

Record: 5 of 5

Figure 10-15. The DE/viewing form for setup conditions measurements.

10.2.4. Equipment Positioning

Positioning

Source: Positioning sheet	
Tables	Forms
EPositioning	Epositioning

The information related to MEM/PEM positioning is recorded here. Use the comment field to describe the microenvironmental situations and setups.

cid: 632 rooms:

lroom: Opos: Wpos:

lpos: Obalcony: B Proom:

Ifloor:

comment:

Record: 1 of 2 (Filtered)

Figure 10-16. The DE/viewing form for equipment positioning data.

10.2.5.Runs for Samples



Source: MEM and PEM sheets, Changing filters -sheet	
Tables	Forms
Eruns	TASK 24: Runs only
Esamples	TASK 24: Runs with samples

The EADB provides two ways for entering sampling time information for the samples.

First one provides you with the cid and rid and gives you the customer's sample numbers to start with. The second one gives you plain access to the **ERuns** table.

The default is to have the sample numbers prefilled; this form is launched from the bigger button. The small blank button is used to launch the **Runs Only** -form.

10.2.5.1.Using Runs with Samples -form



This form shows all samples entered into the **ESamples** table for each customer. When entering the first run for each sample, you need not enter the sample number at all.

When entering the second run for each sample, you copy the sample number from R:sid column to the last row (new record row) and enter 2 as run number.

Dataentry can be made a little bit easier by selecting carefully the order of samples for the second runs, as then it is possible to use the copy upper field -shortcut key to copy identical timing values.

You cannot delete records using this form, as then also the corresponding record in **ESamples** table is deleted.

TASK 24: Runs with samples													
	cid	rid	env	dup	spl	S:sid	R:sid	run	Start	End	Vmem	ok	comment
▶	1148	TR	I	1	N	108345							
	1148	TR	O	1	N	108438							
	1148	TR	O	2	N	111228							
	1148	TR	P	1	N	109368							
	1148	TR	W	1	N	110298							
*													

Record: 14 of 5 (Filtered)

Figure 10-1. Entering runs from the TASK 24: Runs with samples -form.

10.2.5.2.Using Runs Only -form



When using this form, you have to enter all the sample numbers manually, and you do not have access to runs of a specific customer.

This form can be used to delete records from the **ERuns** table (if the logged user account has delete permissions).

TASK 24: Runs only								
	sid	run	Start	End	Vmem	rok	comment	
	992574	1	05.02.97 19:00	06.02.97 07:00	12.02	1		
	992574	2	06.02.97 19:00	07.02.97 07:00	12.02	1		
	994851	1	13.01.97 09:30	13.01.97 14:00	4.5	1		
	994851	2	14.01.97 09:30	14.01.97 14:00	4.5	1		
	994950	1	15.01.97 18:00	16.01.97 07:00	13.02	1		
	994950	2	16.01.97 18:00	17.01.97 07:00	13.024	1		
	995643	1				1		
	998217	1	15.12.96 20:30	16.12.96 07:30	11.01	1		
	998217	2	16.12.96 20:30	17.12.96 07:30	11.02	1		
	998316	1	27.11.96 20:00	28.11.96 08:00	12.02	1		
	998316	2	28.11.96 20:00	29.11.96 05:00	9.01	2	low battery, 3 h shorter run	
*		1				0		

Record: 1 of 1573

Figure 10-2. Entering runs from the TASK 24: Runs only -form.

11. Questionnaires

LongQ data 

A series of forms are used to enter the long questionnaire data and the 48 hour questionnaire data after the measurement.

The N/A (non applicable) code -8 is used in questionnaires when the answer to a question does not apply to the current customer. Eg. when the customer is not working, there is no meaning in the answer to a question like *What kind of carpet is in your working place?*

Also many questions are not asked in every center. In fields related to the questions not asked locally you should enter the -9 (missing) code.

11.1. Long Questionnaire

Source: Customer Long Questionnaire	
Tables	Forms
EQLong	EQLong1
	EQLong2
	EQLong3
	EQLong4

Long questionnaire dataentry is divided into four forms that are linked to each other. Each form consists of parameters fitting into one VGA screen.

The last form, **EQLong4** links forward to the **EQLong48h1** form.

Enter -9 for missing values to mark clearly that dataentry has been done. Enter -8 for non applicable values (when the answer to the question has no meaning).

A **Health** button links the fourth long questionnaire form to the Basel health questionnaire.

Figure 11-3. Entering long questionnaire: the first form of four as an example.

11.2. Basel Health Questionnaire

Source: Customer Long Questionnaire	
Tables	Forms
EQHealth	EQHealth

A separate table is used to store the health related questionnaires applied at least in Basel. This table is linked between the forms EQLong4 and EQLong48h1.

11.3. 48 hour Questionnaire

Source: Customer Long Questionnaire	
Tables	Forms
EQ48h	EQLong48h1
	EQLong48h2

The 48 hour questionnaire continues from the **EQLong4** form.

The 48 hour questionnaire dataentry is divided into two forms, each having parameters so that the form fits onto one VGA screen.

The **Done** button in the end of the last form closes all long questionnaire related DE forms.

Figure 11-4. Entering 48 hour questionnaire.

12. TLAD w/ μ E Temperatures

12.1. Customer CO Files

The databear data is downloaded after the measurement either with EIBEARM.EXE (DOS based, produced by equipment manufacturer) or LANGAN.EXE (Windows based, produced by Otto Hänninen; see Instruction sheet: Using LANGAN.EXE).

The download files are named differently in different programs. EIBEARM.EXE produces several files per customer, which must later be combined into one file per customer. This is done with EIB_COMB.EXE and the use is described in instruction sheet: Using EIB_COMB.EXE.

The download files are stored into a subdirectory of the DATA directory, named CO.

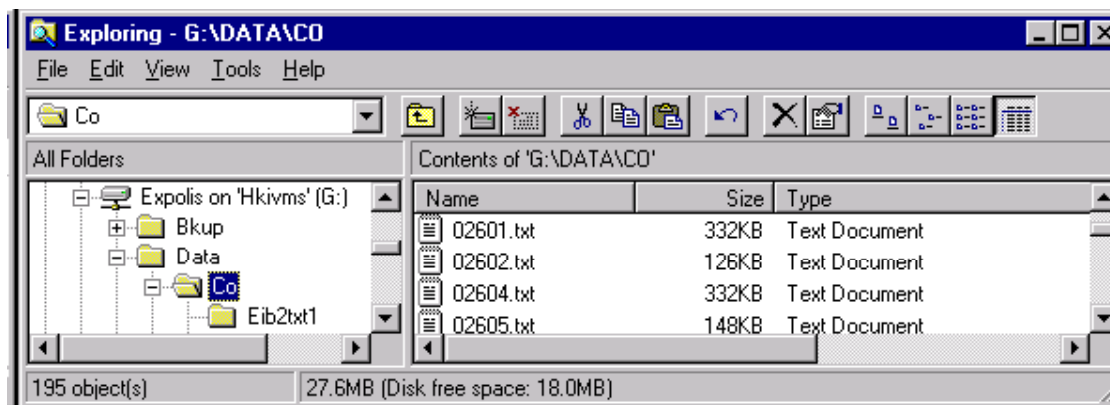

Figure 12-5. Storing CO download files into directory DATA\CO.

In case of using EIBEARM.EXE for downloading, the EIBEARM files are converted into .TXT format with EIB_COMB.EXE in batches. A subdirectory is created for each batch into the CO directory and the file conversion is done there.

The .TXT files (either directly downloaded with LANGAN.EXE or converted from EIBEARM files) are opened into Excel file LANGAN.XLS and the customers data is graphed there.

12.2. Entering TLAD data

The customer.XLS contains a sheet for TLAD data entry. Data is entered in the same format as it is on the paper TLAD sheet.

>> the dataentry tool for TLAD data will be available later. OH 8.4.1997

13. Closing a Customer

After measurement and dataentry the customer's data is checked. Revealed errors are corrected and missing dataentry steps are completed.

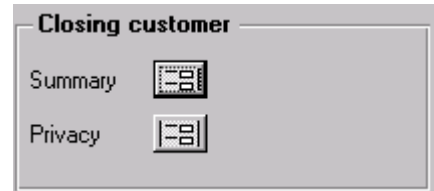

When the data is approved, the customer is closed by removing privacy protected data from the EADB and marking the customer as measured.

13.1. Checking Customer Data

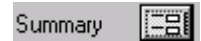

Tables	Forms
(all tables)	CE Summary (w/ several sub forms)

The **CE Summary** form is used to create a summary of customer data.

This form is used as checking tool to make sure that all data has been entered into EADB and that the timing values are reasonable.

The **CE Summary** consists of several parts/subforms:

- **CA tables** identify missing personal entries in tables that have 1 record per customer
For each missing entry do the DE
- **Record counts** count customer's records from tables that have multiple records per customer
Calculate the expected number of records for each of these tables and compare the result to the shown summary. If number does not match, check and complete the dataentry
- **Sampling range** the start of first run, the end of last run, total length of sampling period
Check the dates and times.
- **Sample crosstab** calculate samples by type and by microenvironment
Is the number and type of samples in each microenvironment as expected?
Correct if necessary.
- **List Samples** samples w/number of runs and total sampling length in days and in hours
Check the number of runs per sample: are all runs entered? Is the total sampling time for each sample as expected? Correct as necessary.
- **CO data** indication that CO data has been downloaded
Use Explorer to check that the download files exist. Use Excel and LANGAN.XLS to create the customer .XLS and print the CO data. Mark what is the status of the CO data.
- **TLAD data** indication that TLAD data has been received and checked
Check the TLAD and mark the status.

For a customer to be complete there should be a record or records in all related tables and no field in these table should be empty (enter -9 when question was not asked and -8 when this value has no meaning for this record, eg. work related questions when customer is not working).

If everything is ok, the customer can be closed by removing the privacy protected information from the database and marking the customer as measured.

CE Summary : Form

cid: OH

CA tables

- P Stat ECondCustome
- P NAMES EEquipment
- ShortQ EFlows
- EContact ESamples
- LongQ ERuns
- 48hQ
- EPositioning

Customer sampling range subform

- = d

Databear CO and T data:

dlok

TLAD data:

tllok

Customer sample summary subform

	spl	I	O	W	P
▶	1	1	1	2	1
	2				1
	v	1	1	2	1

Goto Form

Customer samples subform

	e	s	d	sid	r	d	h
▶	i	1	1	752697	2	1.05	25.15
	i	v	1	390258	2	1.05	25.15
	o	1	1	813681	2	1.06	25.33
	o	v	1	301653	2	1.06	25.33
	p	1	1	658350	2	0.87	20.83
	p	v	1	229680	1	1.93	46.33
	p	2	1	595881	2	1.06	25.50
	w	1	1	729432	2	0.67	16.00
	w	v	1	182259	2	0.67	16.00
	w	1	2	988416	2	0.67	16.00
	w	v	2	294723	2	0.67	16.00

Record: of 3 (Filtered)

Figure 13-6. Checking the customer's data.

13.2. Removing Privacy Protected Data

Tables	Forms
P NAMES	CB Privacy

If all of the data passes the summary check in previous chapter, the customer can be closed.

The **CB Privacy** form (CB stands for Customers - Both) is opened from Welcome screen or from the **CE Summary** form. All fields marked with blue are erased.

The customer status is marked as 'm'.

The screenshot shows a window titled "CB Privacy : Form". The interface includes a header section with "P Stat" and fields for "cid", "select" (set to 2000), and "comment". Below this are "answer" (set to 'a'), "stat" (set to 'y'), and "rid" (set to 'OH'). There are also "Filters" buttons for "My", "Bln", and "All", and a "Print this page" button.

The main section is titled "P NAMES" and contains several fields, many of which are highlighted in blue to indicate they are privacy-protected data. These include "hphone", "name", "wphone", "fname", "spouse", "street", "wstreet", "streetnr", "wstreetnr", "zip", "wzip", "city", "wcity", "cityq", "wcityq", "staco", "wstaco", and "pnok". The "name" field contains the text "Imaginary database test person". The "street" field contains "Imaginary street address B1". The "city" field contains "IMAGINE".

At the bottom right, there is a "Goto Form" section with buttons for "Stat", "ShortQ", "Names", "LongQ", "Welco", and "48hQ". At the bottom left, there is a "Record:" section with navigation buttons and the text "1 of 3 (Filtered)".

Figure 13-7. Checking the customer's data.

14. Common Questions

This section lists some questions that have come up with the database. If you have a problem, check this section; maybe it has a solution just for you.

14.1. *This aren't working, and I don't understand a heck of it*

Well, the EADB is a rather complex system. It is expected that many or all users will experience difficult moments trying to get everything up and running. If there is a problem you cannot solve, please feel free to call Otto at +358-9-5885 182 (office) or +358-400-673 207 (GSM).

You can also fax prints of forms you cannot make to work; the fax number is +358-9-4744 786. Prints help me to figure out your situation. I'm sure that together we can solve it.

14.2. *Why my customer's data is not visible in Measurement forms?*

The customer's record in some of the tables is missing, or some field has illegal value. Check the following:

- customer must be in **P Stat** table and the field
P Stat.stat must be 'y' or 'yg' (use **Customers** button to view this table)

The **P Stat.select** must be in range 2001-2999 for exposure customers and in range 3001-3999 for TLADo customers to make them visible in the contacting form.
- customer must have a record in the short questionnaire table **P ShortQ** and the field
P ShortQ.particip must be 1 (Exposure measurement) or 2 (diary only)

Open ShortQ form using the **ShortQ** button and check/correct/create the record for this customer.
- customer must have a record in the table **EContact**

Use **Contacting customers / Exp** button and create the record using the bottom part of the form.

14.3. *Why the sampled VOC volume isn't shown in VOC tubes back to analysis?*

The sampled volume is calculated from the values in **ERuns** and **EFlows** tables. Check that these values have been entered for the tube. Also, check that the tube has been entered as a sample to the **ESamples** form - this will bind the tube to a customer and bring the rid to the VOC tube report.

14.4. *All values in related tables are entered, and still the form does not show it?*

Access uses a feature called *filter* to filter (select) records from record sets (tables, queries). When conflicting filters are applied, no records pass through. In this case the bottom line shows Record 1 of 1 (Filtered). To see all records, inactivate the filter by pressing the button  on toolbar.

14.5. What is Run-time error?

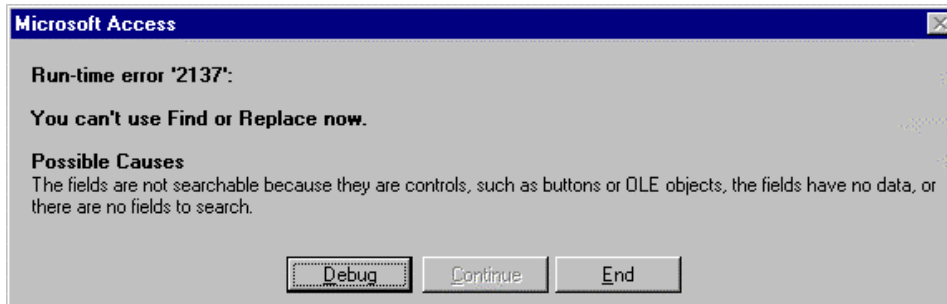

Some functionality of the EADB is programmed. When the programmed code comes up with a situation that was not expected, the code causes a run time error.

In Helsinki the common cause for this error is the ability of some forms to automatically find the same customer that was processed in the previous form. If your form has been filtered to exclude all records (record counter in the bottom of the form shows Record 1 of 1, Filtered) the automatic find operation fails and produces the error dialog above.

In case of run time error, press the End button. Remove filter, if it is not necessary.

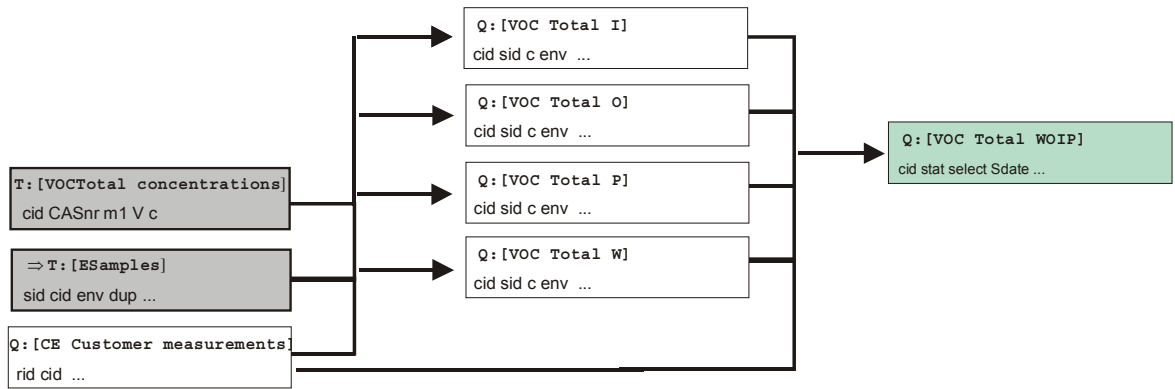
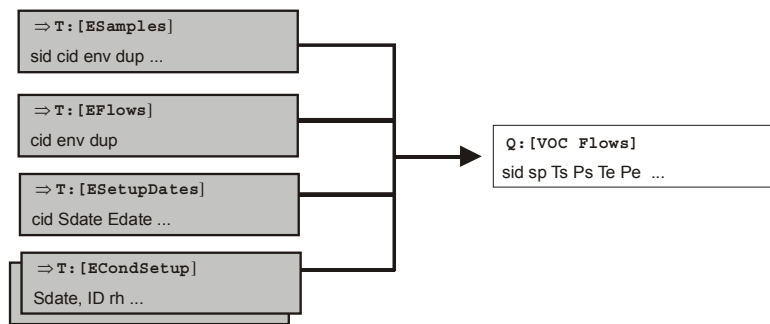
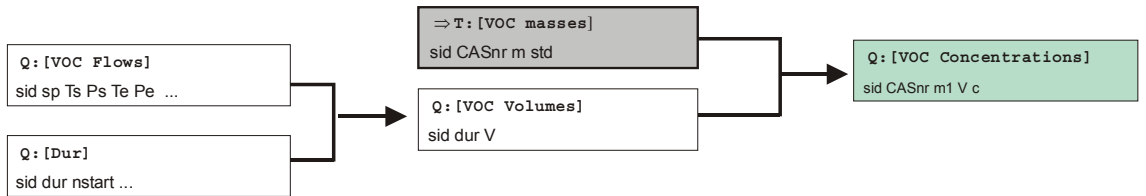

How to Calculate VOC Concentrations From the *EXPOLIS* Database

Otto Hänninen, Sari Alm, Jouni Jurvelin and Esa Kaarakainen

KTL Environmental Health
P.O.Box 95
FI-70701 KUOPIO
FINLAND

Contents

1.	INTRODUCTION	5
2.	VOC TABLES	6
2.1	* [VOC compounds]	6
2.2	* [VOC Detection limit]	6
2.3	* [VOC masses]	7
2.4	[VOC shipments]	7
2.5	[VOC tubes]	7
2.6	Other tables	8
3.	VOC QUERIES NOT USED FOR CIDB DATA	9
3.1	[VOC blank m]	9
3.2	[VOC CE mass nonzero counts]	9
3.3	[VOC Concentrations]	9
3.4	[VOC crosstab]	10
3.5	[VOC select tubes for crosstab]	10
3.6	[VOC duplicate m&c]	10
3.7	[VOC duplicate subquery]	11
3.8	[VOC mass counts for batches]	11
3.9	[VOC mass counts for samples]	11
3.10	[VOC mass counts for targets]	12
3.11	[VOC mass nonzero counts]	12
3.12	[VOC masses >= 0]	12
3.13	[VOC masses non target]	13
3.14	[VOC masses target]	13
3.15	[VOC Paste Errors vs Masses]	13
3.16	[VOC results vs Paste Errors]	14
3.17	[VOC sampling summary]	14
3.18	[VOC shipment tube counts]	14

3.19	[VOC total concentrations]	15
3.20	[VOC Total I]	15
3.21	[VOC Total O]	15
3.22	[VOC Total P]	16
3.23	[VOC Total W]	16
3.24	[VOC Total WOIP]	16
3.25	[VOC tubes back to analysis]	17
3.26	Other queries	17
4.	VOC QUERIES USED FOR CIDB DATA	18
4.1	* [VOC Volumes]	18
4.2	* [VOC lod mass]	18
4.3	* [VOC Flows]	19
4.3.1	* [VOC Flows] in other centres.....	19
4.3.2	* [VOC Flows] in Milan	19
4.4	* [VOC lod c]	20
4.5	* [VOC lod c I]	20
4.6	* [VOC lod c O]	21
4.7	* [VOC lod c P]	21
4.8	* [VOC lod c W]	22

1. Introduction

This document describes the VOC tables and the concentration query network. The graph in the cover shows the logical order in which the queries are used.

The variables (fields) used in the query network are not separately documented.

All tables and queries needed in creating Combined International Expolis Database (CIDB) are marked with asterisk (*).

13.12.2000 eKa

24.5.2002 OH

2. VOC tables

This chapter represents VOC tables in alphabetical order. Tables needed in creating CIDB are marked with asterisk (*).

2.1 * [VOC compounds]

Field Name	Data Type	Description
CASnr	Text	
grp	Text	
name	Text	
Merck	Number	Merck Index (12th ed) monograph number
et	Number	This compound is Expolis target?

Field Properties	
General	Lookup
Field Size	20
Format	
Input Mask	
Caption	
Default Value	
Validation Rule	
Validation Text	
Required	No
Allow Zero Length	No
Indexed	Yes (No Duplicates)

This property cannot be modified in linked tables.

2.2 * [VOC Detection limit]

This table was not used in Basel.

Field Name	Data Type	Description
CASnr	Text	
Compound	Text	
Group	Text	
Tenax TA	Text	
Calc from	Text	
lod	Number	(ng/tube)

Field Properties	
General	Lookup
Field Size	255
Format	
Input Mask	
Caption	
Default Value	
Validation Rule	
Validation Text	
Required	No
Allow Zero Length	No
Indexed	Yes (No Duplicates)

This property cannot be modified in linked tables.

2.3 * [VOC masses]

Field Name	Data Type	Description
sid	Number	Expolis sample number
CASnr	Text	CAS number of the compound
m	Number	The compound mass in the sample
std	Text	T=toluene standard P=pure compound standard

Field Properties

General	Lookup
Field Size	Long Integer
Format	
Decimal Places	Auto
Input Mask	
Caption	
Default Value	
Validation Rule	
Validation Text	
Required	Yes
Indexed	No

This property cannot be modified in linked tables.

2.4 [VOC shipments]

Field Name	Data Type	Description
batch	Number	Batch number
idate	Date/Time	Arrival date from VTT
odate	Date/Time	Mailing date to VTT
n	Number	Number of tubes
name	Text	File name of results
comment	Memo	Any comments regarding this shipment

Field Properties

General	Lookup
Field Size	Long Integer
Format	
Decimal Places	Auto
Input Mask	
Caption	
Default Value	
Validation Rule	
Validation Text	
Required	Yes
Indexed	Yes (No Duplicates)

This property cannot be modified in linked tables.

2.5 [VOC tubes]

Field Name	Data Type	Description
batch	Number	Batch number
sid	Number	Expolis sample number
tubecode	Text	The tenax tube code
Comment	Memo	Any comments regarding this tube

Field Properties

General	Lookup
Field Size	Long Integer
Format	
Decimal Places	Auto
Input Mask	
Caption	
Default Value	
Validation Rule	
Validation Text	
Required	No
Indexed	Yes (Duplicates OK)

This property cannot be modified in linked tables.

2.6 Other tables

Following tables are also used with VOC calculations but not represented in this document:

- ESamples
- Eflows
- Econdsetup
- Esetupdates

See CQN-PM2.5 documentation for these tables.

3. VOC queries not used for CIDB data

3.1 [VOC blank m]

VOC blank m : Select Query

Field:	batch	sid	CASnr	m1: m	dup	m2: m	c	dup	r%: ((m1)/[m2])*100	cid	env
Table:	VOC ship	VOC tub	VOC masses	VOC masses	ESamples	VOC masses_1	VOC Conce	ESamples_1		ESamp	ESamples
Sort:											
Show:	<input checked="" type="checkbox"/>	<input checked="" type="checkbox"/>	<input checked="" type="checkbox"/>	<input checked="" type="checkbox"/>	<input checked="" type="checkbox"/>	<input checked="" type="checkbox"/>	<input checked="" type="checkbox"/>	<input checked="" type="checkbox"/>	<input checked="" type="checkbox"/>	<input checked="" type="checkbox"/>	<input checked="" type="checkbox"/>
Criteria:			"000110-54-3"		10			1			
or:											

3.2 [VOC CE mass nonzero counts]

VOC CE mass nonzero counts : Select Query

Field:	cid	env	dup	spl	sok	targets	nontargets
Table:	CE Customer measurements	ESamples	ESamples	ESamples	ESamples	VOC mass nonzero counts	VOC mass nonzero counts
Sort:	Ascending						
Show:	<input checked="" type="checkbox"/>	<input checked="" type="checkbox"/>	<input checked="" type="checkbox"/>	<input checked="" type="checkbox"/>	<input checked="" type="checkbox"/>	<input checked="" type="checkbox"/>	<input checked="" type="checkbox"/>
Criteria:		"P"	1	"V"			
or:							

3.3 [VOC Concentrations]

VOC Concentrations : Select Query

Field:	sid	CASnr	m1: If([m]>0,[m],0)	V	c: [m1]/[V]
Table:	VOC masses	VOC masses		VOC Volumes	
Sort:					
Show:	<input checked="" type="checkbox"/>	<input checked="" type="checkbox"/>	<input checked="" type="checkbox"/>	<input checked="" type="checkbox"/>	<input checked="" type="checkbox"/>
Criteria:					
or:					

3.7 [VOC duplicate subquery]

VOC duplicate subquery : Select Query

Field:	batch	sid	CASnr	name	m	dup	cid	env
Table:	VOC shipments	VOC tubes	VOC masses	VOC compounds	VOC masses	ESamples	ESamples	ESamples
Sort:	Ascending	Ascending						
Show:	<input checked="" type="checkbox"/>	<input checked="" type="checkbox"/>	<input checked="" type="checkbox"/>	<input checked="" type="checkbox"/>	<input checked="" type="checkbox"/>	<input checked="" type="checkbox"/>	<input checked="" type="checkbox"/>	<input checked="" type="checkbox"/>
Criteria:				"benzene"		1 Or 2		

3.8 [VOC mass counts for batches]

VOC mass counts for batches : Select Query

Field:	batch	n	m
Table:	VOC shipments	VOC shipments	VOC masses
Total:	Group By	Group By	Count
Sort:			
Show:	<input checked="" type="checkbox"/>	<input checked="" type="checkbox"/>	<input checked="" type="checkbox"/>
Criteria:			

3.9 [VOC mass counts for samples]

VOC mass counts for samples : Select Query

Field:	sid	m
Table:	VOC tubes	VOC masses
Total:	Group By	Count
Sort:		
Show:	<input checked="" type="checkbox"/>	<input checked="" type="checkbox"/>
Criteria:		

3.10 [VOC mass counts for targets]

VOC mass counts for targets : Select Query

Field:	batch	sid	m	
Table:	VOC tubes	VOC tubes	VOC masses	
Total:	Group By	Group By	Count	
Sort:				
Show:	<input checked="" type="checkbox"/>	<input checked="" type="checkbox"/>	<input checked="" type="checkbox"/>	<input type="checkbox"/>
Criteria:				
or:				

3.11 [VOC mass nonzero counts]

VOC mass nonzero counts : Select Query

Field:	sid	targets: sid	nontargets: sid	
Table:	VOC masses >=0	VOC masses target	VOC masses non-ta	
Total:	Group By	Count	Count	
Sort:				
Show:	<input checked="" type="checkbox"/>	<input checked="" type="checkbox"/>	<input checked="" type="checkbox"/>	<input type="checkbox"/>

3.12 [VOC masses >= 0]

VOC masses >=0 : Select Query

Field:	sid	CASnr	m	std
Table:	VOC masses	VOC masses	VOC masses	VOC masses
Sort:				
Show:	<input checked="" type="checkbox"/>	<input checked="" type="checkbox"/>	<input checked="" type="checkbox"/>	<input checked="" type="checkbox"/>
Criteria:			>=0	
or:				

3.13 [VOC masses non target]

VOC masses non-target : Select Query

Field:	sid	CASnr	m	std	CASnr	et
Table:	VOC masses	VOC masses	VOC masses	VOC masses	VOC compounds	VOC compounds
Sort:						
Show:	<input checked="" type="checkbox"/>	<input checked="" type="checkbox"/>	<input checked="" type="checkbox"/>	<input checked="" type="checkbox"/>	<input checked="" type="checkbox"/>	<input checked="" type="checkbox"/>
Criteria:					Is Null	
or:						0

3.14 [VOC masses target]

VOC masses target : Select Query

Field:	sid	CASnr	m	std	et
Table:	VOC masses	VOC masses	VOC masses	VOC masses	VOC compounds
Sort:					
Show:	<input checked="" type="checkbox"/>	<input checked="" type="checkbox"/>	<input checked="" type="checkbox"/>	<input checked="" type="checkbox"/>	<input checked="" type="checkbox"/>
Criteria:					1
or:					

3.15 [VOC Paste Errors vs Masses]

VOC Paste Errors vs Masses : Select Query

Field:	Paste Errors.*	VOC masses.*
Table:	Paste Errors	VOC masses
Sort:		
Show:	<input checked="" type="checkbox"/>	<input checked="" type="checkbox"/>
Criteria:		
or:		

3.16 [VOC results vs Paste Errors]

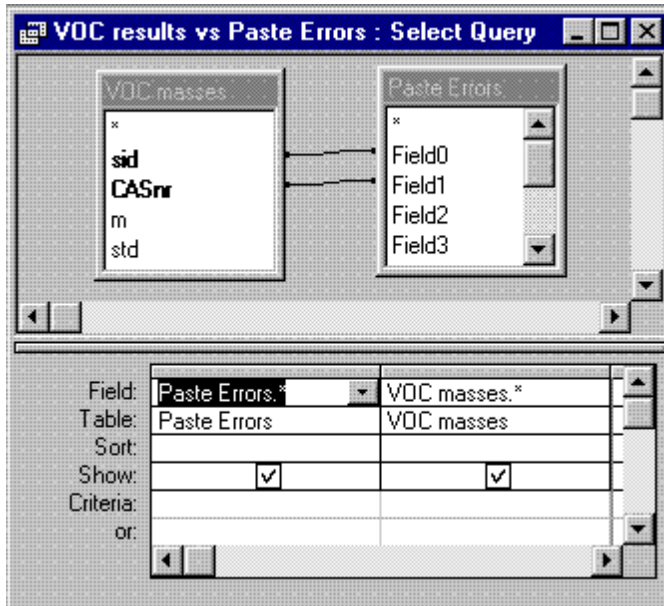

3.17 [VOC sampling summary]

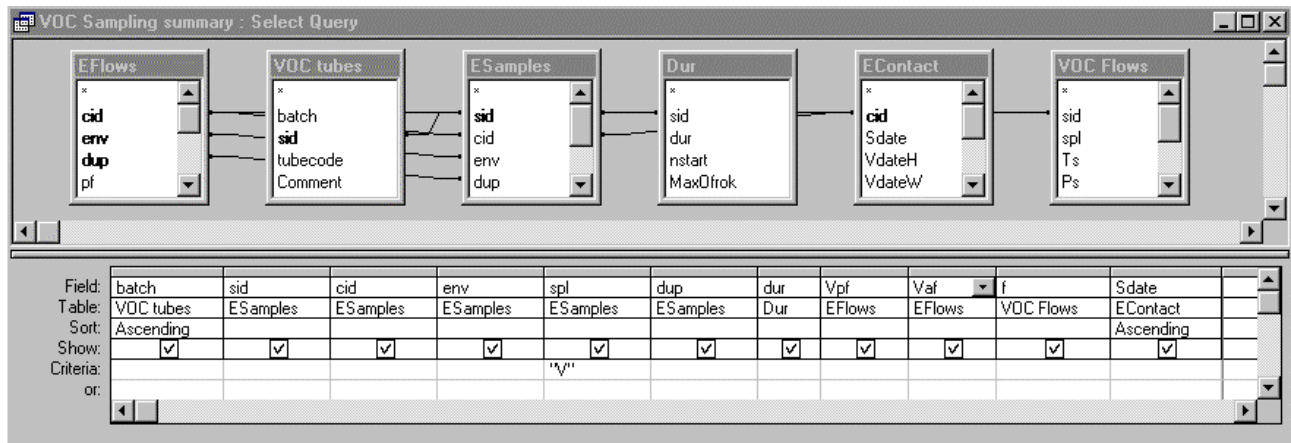

3.18 [VOC shipment tube counts]

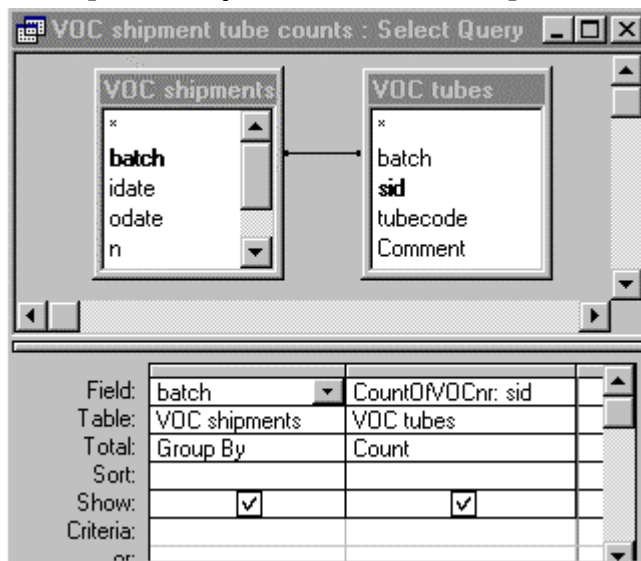

3.19 [VOC total concentrations]

Voc Total Concentrations : Select Query

VOC Concentrations

- *
 - sid
 - CASnr
 - m1
 - V
 - c

Field:	sid	CASnr	m1	V	c
Table:	VOC Concentrations	VOC Concentrations	VOC Concentrations	VOC Concentrations	VOC Concentrations
Sort:					
Show:	<input checked="" type="checkbox"/>	<input checked="" type="checkbox"/>	<input checked="" type="checkbox"/>	<input checked="" type="checkbox"/>	<input checked="" type="checkbox"/>
Criteria:		"TVOC"			
or:					

3.20 [VOC Total I]

VOC Total I : Select Query

ESamples

- *
 - sid
 - cid
 - env
 - dup
 - spl
 - sok
 - comment

VOC Total concentrations

- *
 - sid
 - CASnr
 - m1
 - V
 - c

CE Customer measurements

- *
 - rid
 - cid
 - answer
 - stat
 - select
 - comment
 - Sdate

Field:	cid	sid	c	env	dup	spl	sok
Table:	ESamples	ESamples	VOC Total concentrations	ESamples	ESamples	ESamples	ESamples
Sort:							
Show:	<input checked="" type="checkbox"/>	<input checked="" type="checkbox"/>	<input checked="" type="checkbox"/>	<input checked="" type="checkbox"/>	<input checked="" type="checkbox"/>	<input checked="" type="checkbox"/>	<input checked="" type="checkbox"/>
Criteria:				"I"	1	"V"	Is Null Or <>3
or:							

3.21 [VOC Total O]

VOC Total O : Select Query

ESamples

- *
 - sid
 - cid
 - env
 - dup
 - spl
 - sok
 - comment

VOC Total c...

- *
 - sid
 - CASnr
 - m1
 - V
 - c

CE Customer measurements

- *
 - rid
 - cid
 - answer
 - stat
 - select
 - comment
 - Sdate
 - street

Field:	cid	sid	c	env	dup	spl	sok
Table:	ESamples	ESamples	VOC Total concentrations	ESamples	ESamples	ESamples	ESamples
Sort:							
Show:	<input checked="" type="checkbox"/>	<input checked="" type="checkbox"/>	<input checked="" type="checkbox"/>	<input checked="" type="checkbox"/>	<input checked="" type="checkbox"/>	<input checked="" type="checkbox"/>	<input checked="" type="checkbox"/>
Criteria:				"O"	1	"V"	Is Null Or <>3
or:							

3.22 [VOC Total P]

Field:	cid	sid	c	env	dup	spl	sok
Table:	ESamples	ESamples	VOC Total concentrations	ESamples	ESamples	ESamples	ESamples
Sort:							
Show:	<input checked="" type="checkbox"/>	<input checked="" type="checkbox"/>	<input checked="" type="checkbox"/>	<input checked="" type="checkbox"/>	<input checked="" type="checkbox"/>	<input checked="" type="checkbox"/>	<input checked="" type="checkbox"/>
Criteria:				"P"	1	"V"	Is Null Or <>3
or:							

3.23 [VOC Total W]

Field:	cid	sid	c	env	dup	spl	sok
Table:	ESamples	ESamples	VOC Total concentrations	ESamples	ESamples	ESamples	ESamples
Sort:							
Show:	<input checked="" type="checkbox"/>	<input checked="" type="checkbox"/>	<input checked="" type="checkbox"/>	<input checked="" type="checkbox"/>	<input checked="" type="checkbox"/>	<input checked="" type="checkbox"/>	<input checked="" type="checkbox"/>
Criteria:				"W"	1	"V"	Is Null Or <>3
or:							

3.24 [VOC Total WOIP]

Field:	cid	stat	select	Sdate	CI: c	CO: c	CP: c	CW: c
Table:	CE Custo	CE Custo	CE Custo	CE Custo	VOC Total I	VOC Total O	VOC Total P	VOC Total W
Sort:								
Show:	<input checked="" type="checkbox"/>	<input checked="" type="checkbox"/>	<input checked="" type="checkbox"/>	<input checked="" type="checkbox"/>	<input checked="" type="checkbox"/>	<input checked="" type="checkbox"/>	<input checked="" type="checkbox"/>	<input checked="" type="checkbox"/>
Criteria:								
or:								

3.25 [VOC tubes back to analysis]

Field:	batch	sid	tubecode	Comment	cid	env	dup	dur	Vpf	Vaf	Vf	V: [dur]*60*(Vf)/1000	rid
Table:	VOC tub	VOC	VOC tubes	VOC tubes	ESamples	ESamples	ESamples	Dur	CE S.	CE S.	CE S.		P Stat
Sort:													
Show:	<input checked="" type="checkbox"/>	<input checked="" type="checkbox"/>	<input checked="" type="checkbox"/>	<input checked="" type="checkbox"/>	<input checked="" type="checkbox"/>	<input checked="" type="checkbox"/>	<input checked="" type="checkbox"/>	<input checked="" type="checkbox"/>	<input checked="" type="checkbox"/>	<input checked="" type="checkbox"/>	<input checked="" type="checkbox"/>	<input checked="" type="checkbox"/>	<input checked="" type="checkbox"/>
Criteria:													
or:													

3.26 Other queries

Following queries are also used with VOC calculations but not represented in this document:

- Dur
- CE Customer measurements

See CQN-PM2.5 documentation for these tables.

4. VOC queries used for CIDB data

4.1 * [VOC Volumes]

VOC Volumes : Select Query

Field:	sid	dur	V: [f]*[dur]*60/1000	
Table:	VOC Flows	Dur		
Sort:				
Show:	<input checked="" type="checkbox"/>	<input checked="" type="checkbox"/>	<input checked="" type="checkbox"/>	<input type="checkbox"/>
Criteria:		>0		
or:				

4.2 * [VOC lod mass]

VOC lod mass : Select Query

Field:	sid	CASnr	m_lod: If([m]>[lod],[m],[lod]/2))	LODok: If([m]>[lod],1,2)
Table:	VOC masses	VOC masses		
Sort:				
Show:	<input checked="" type="checkbox"/>	<input checked="" type="checkbox"/>	<input checked="" type="checkbox"/>	<input checked="" type="checkbox"/>
Criteria:				
or:				

4.3 * [VOC Flows]

Due to the nature of Milan VOC data a different query had to be used.

4.3.1 * [VOC Flows] in other centres

The screenshot shows a query design window titled "VOC Flows : Select Query". It features five tables: ESamples, EFlows, ECondSetup, ESetupDates, and ECondSetup_1. Lines connect fields between tables to indicate relationships. Below the tables is a grid for defining the query's fields and criteria.

Field:	sid	spl	Ts: T	Ps: P	Te: T	Pe: P	f: FlowAvg([Vpf],[Ts],[Ps],[Vaf],[Te],[Pe])	ok: OkMax4([Vok],[ECondSetup].[scok],[ECondSetup_1].[scok],1)
Table:	ESam	ESai	ECon	ECon	ECondSt	ECondS		
Sort:								
Show:	<input checked="" type="checkbox"/>	<input checked="" type="checkbox"/>	<input checked="" type="checkbox"/>	<input checked="" type="checkbox"/>	<input checked="" type="checkbox"/>	<input checked="" type="checkbox"/>	<input checked="" type="checkbox"/>	<input checked="" type="checkbox"/>
Criteria:		"V"						
or:								

4.3.2 * [VOC Flows] in Milan

The screenshot shows a query design window titled "VOC Flows : Select Query" for Milan. It features three tables: VOC tubes, ESamples, and EFlows. Lines connect fields between tables. Below the tables is a grid for defining the query's fields and criteria.

Field:	sid	Vpf	Vaf	f: ([Vpf]+[Vaf])/2	ok: Vok
Table:	ESamples	EFlows	EFlows		EFlows
Sort:					
Show:	<input checked="" type="checkbox"/>	<input checked="" type="checkbox"/>	<input checked="" type="checkbox"/>	<input checked="" type="checkbox"/>	<input checked="" type="checkbox"/>
Criteria:		<>-9	<>-9		
or:					

4.4 * [VOC lod c]

VOC lod c : Select Query

Field:	sid	CASnr	V	c: [m_lod]/[V]	LODok	fok: ok
Table:	VOC lod mass	VOC lod mass	VOC Volumes		VOC lod mass	VOC Flows
Sort:						
Show:	<input checked="" type="checkbox"/>	<input checked="" type="checkbox"/>	<input checked="" type="checkbox"/>	<input checked="" type="checkbox"/>	<input checked="" type="checkbox"/>	<input checked="" type="checkbox"/>
Criteria:						
or:						

4.5 * [VOC lod c I]

VOC lod c I : Select Query

Field:	cid	sid	CASnr	c	env	dup	spl	sok
Table:	ESamples	ESamples	VOC lod c	VOC lod c	ESamples	ESamples	ESamples	ESamples
Sort:								
Show:	<input checked="" type="checkbox"/>	<input checked="" type="checkbox"/>	<input checked="" type="checkbox"/>	<input checked="" type="checkbox"/>	<input checked="" type="checkbox"/>	<input checked="" type="checkbox"/>	<input checked="" type="checkbox"/>	<input checked="" type="checkbox"/>
Criteria:					"I"	1	"V"	Is Null Or <>3
or:								

4.6 * [VOC lod c O]

VOC lod c O : Select Query

Field:	cid	sid	CASnr	c	env	dup	spl	sok
Table:	ESamples	ESamples	VOC lod c	VOC lod c	ESamples	ESamples	ESamples	ESamples
Sort:								
Show:	<input checked="" type="checkbox"/>	<input checked="" type="checkbox"/>	<input checked="" type="checkbox"/>	<input checked="" type="checkbox"/>	<input checked="" type="checkbox"/>	<input checked="" type="checkbox"/>	<input checked="" type="checkbox"/>	<input checked="" type="checkbox"/>
Criteria:					"0"	1	"V"	Is Null Or <>3
or:								

4.7 * [VOC lod c P]

VOC lod c P : Select Query

Field:	cid	sid	CASnr	c	env	dup	spl	sok
Table:	ESamples	ESamples	VOC lod c	VOC lod c	ESamples	ESamples	ESamples	ESamples
Sort:								
Show:	<input checked="" type="checkbox"/>	<input checked="" type="checkbox"/>	<input checked="" type="checkbox"/>	<input checked="" type="checkbox"/>	<input checked="" type="checkbox"/>	<input checked="" type="checkbox"/>	<input checked="" type="checkbox"/>	<input checked="" type="checkbox"/>
Criteria:					"P"	1	"V"	Is Null Or <>3
or:								

4.8 * [VOC lod c W]

VOC lod c W : Select Query

Field:	cid	sid	CASnr	c	env	dup	spl	sok
Table:	ESamples	ESamples	VOC lod c	VOC lod c	ESamples	ESamples	ESamples	ESamples
Sort:								
Show:	<input checked="" type="checkbox"/>	<input checked="" type="checkbox"/>	<input checked="" type="checkbox"/>	<input checked="" type="checkbox"/>	<input checked="" type="checkbox"/>	<input checked="" type="checkbox"/>	<input checked="" type="checkbox"/>	<input checked="" type="checkbox"/>
Criteria:					'W'	1	'V'	Is Null Or <>3
or:								

Documentation of the
Concentration Query Network
NO₂

How to Calculate NO₂ Concentrations From the *EXPOLIS* Database

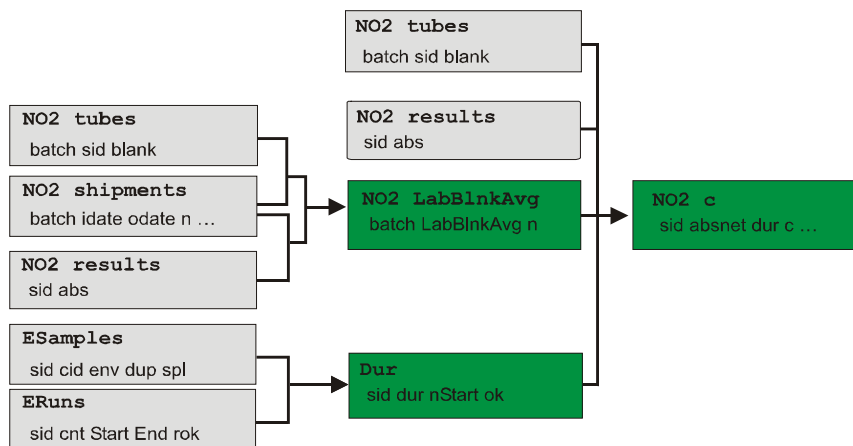

EXPOLIS

KTL Environmental Health
P.O.Box 95
FI-70701 KUOPIO
FINLAND

Otto Hänninen

Email OTTO.HANNINEN@KTL.FI
Tel +358-17-201 171
GSM +358-400-673 207
Fax +358-17-201 265

Kirsi Kumpulainen

KIRSI.KUMPULAINEN@KTL.FI
+358-17-201 172

Contents

1. INTRODUCTION	4
2. THE STURCTURE OF THE CQN - NO₂	
2.1 The Variables Used in the CQN - NO ₂	5
2.2 NO ₂ Tables in Database	5
3. DATA CLEANING QUERIES	6
3.1 NO ₂ Summary tables]	6
3.2 [DC NO2 Blanks]	7
3.3 [DC NO ₂ Lost tubes]	7
3.4 [DC NO ₂ customers], [DC NO ₂ non customers]	8
3.5 [DC NO ₂ Run ok]	9
4. THE CONCENTRATION CALIBRATION QUERIES	10
4.1 [Dur]	10
4.2 [NO ₂ LabBlnkAvg]	11
4.3 [NO ₂ c]	11
5. AGGREGATE QUERIES	13
5.1 [CE Customer measurements]	13
5.2[NO ₂ c I]	14
5.3 [NO ₂ c O]	14
5.4 [NO ₂ c P]	15
5.5 [NO ₂ c W]	15
5.6 [NO ₂ c IOPW]	16
5.7 [NO ₂ duplicates]	16

1. Introduction

The *EXPOLIS* measurement results are stored in the *EXPOLIS* Access database (EADB) in the raw format. These original data include measurement start and end timings, absorbances, blank averages etc.

The main result of these measurements are concentrations. The concentrations are calculated from the raw data using the *Concentration Query Networks*. This document describes the structure of CQN - NO₂ in general and the detailed structure of each query in the network.

I hope that the *EXPOLIS* database system and this concentration calculation network system ensures that we obtain corrected concentration values that are properly calculated and calculated in the same way from the raw data of each center. As this documentation shows, the calculation of a concentration is not the most trivial task.

Any comments and corrections to this crucial concentration calculation procedure are warmly welcome. Let me present my sincere gratitude to all you in Helsinki and in the other centers that have participated in the tests, measurements, calculations, statistical analysis and discussions behind the Concentration Query Network. Let's make concentrations better!

16.9.1998 Kuopio

2. The Structure of the CQN - NO₂ in Database

The Access table-query structure of the NO₂ CQN is shown in the cover of this document.

2.1 The variables used in the CQN - NO₂

The key variables are presented below. The structure of each query are presented in later chapters.

Variable	Explanation
abs	Total measured absorbance unit (AU) of each tube.
absnet	absorbance unit (AU) of exposed NO ₂ tube – blank level f: [abs] - [LabBlnk]
c	NO ₂ concentration (µg m ⁻³) f: ([Absnet]*43370.9-73.74)/[dur]
dur	Exposure time (hours) f: Sum(24*([End]-[Start]))
LabBlnk	Mean absorbance unit (AU) of lab-blanks

2.2 NO₂ Tables in Database

The database stores three tables about NO₂ shipments, tubes and received results e.g. absorbances. This basic data about NO₂ samples and blanks is used in queries calculating concentrations. This section describes these tables, which are [NO2 shipments], [NO2 tubes] and [NO2 results]. Each description includes the print of the table design view from Access.

[NO2 shipments] table shows each batches arrival date from VTT, mailing date to VTT, count of tubes in each batch and comments about this batch.

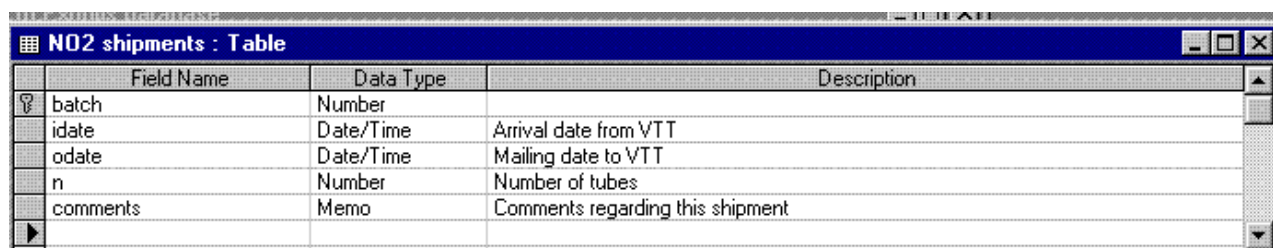

Field Name	Data Type	Description
batch	Number	
idate	Date/Time	Arrival date from VTT
odate	Date/Time	Mailing date to VTT
n	Number	Number of tubes
comments	Memo	Comments regarding this shipment

[NO2 tubes] table shows each tube's batch, sample number, sample status (shipment blank, lab blank or sample) and comments.

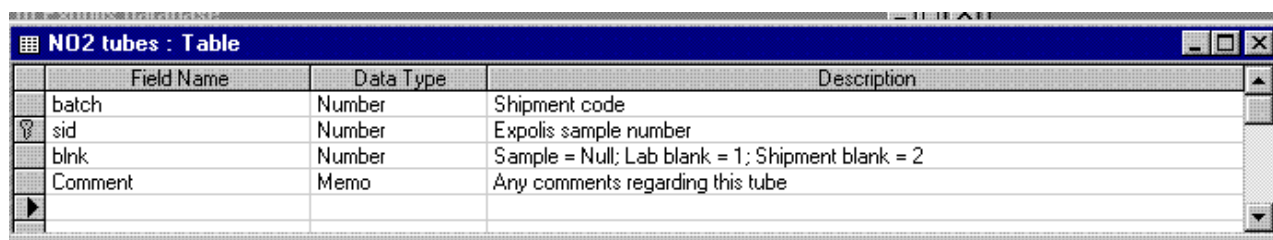

Field Name	Data Type	Description
batch	Number	Shipment code
sid	Number	Expolis sample number
blnk	Number	Sample = Null; Lab blank = 1; Shipment blank = 2
Comment	Memo	Any comments regarding this tube

[NO2 results] table shows each tube's (named sample ID = SID) measured total absorbance.

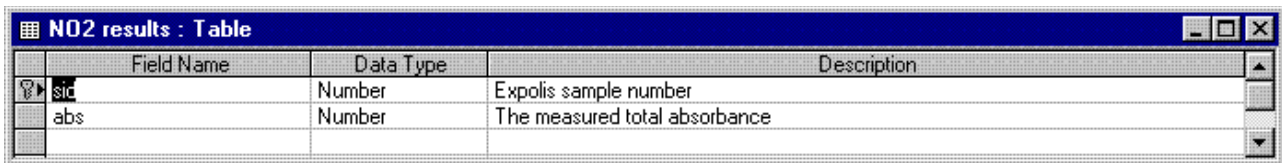

Field Name	Data Type	Description
sid	Number	Expolis sample number
abs	Number	The measured total absorbance

3. Data Cleaning Queries in the CQN - NO₂

In most cases the CQN queries output only records for samples for which all the source tables/queries contain the required records. If some required source records are missing for a sample, the CQN will not output a concentration record for this sample.

It is one of the main tasks of the Data Cleaning step to ensure that all relevant records have been created in each table and that the measured data is correctly entered for these records.

These queries list data cleaning tasks. The names of the queries are presented in brackets, following the Access convention. Each description includes the print of the query design view from Access. The top part of these prints list the source tables/queries and the fields in these. The lower part lists the output fields, calculations and record selection criteria.

3.1 [NO₂ Summary tables]

This form shows records of each tube in tables [ESamples], [NO₂ shipments], [NO₂ tubes] and [NO₂ results] and in queries [NO₂ LabBlnkAvg], [Dur] and [NO₂ c]. Values cannot be edited in this form.

The screenshot shows a Microsoft Access form titled "NO2 Summary Tables : Form". The form is divided into several sections for data entry and viewing:

- ESamples:** Fields for cid, env, dup, spl, and sok.
- NO2 shipments:** batch (1), idate (20.11.96), odate (18.12.96), n (120), and comments (10 tubes to anal 20.12.96).
- NO2 tubes:** batch (1), sid (100068), blnk (2), and comment (shipment blank).
- NO2 LabBlnkAvg:** batch (1), LabBlnk (0.0000), and n (1).
- dur:** sid (100068) and abs (0.005).
- NO2 c:** batch, sid, Absnet, dur, and c.

A data grid at the top right shows the following record:

sid	run	Start	End	Vmem	rok
1000	1				

Navigation controls at the bottom indicate "Record: 1 of 1039".

3.2 [DC NO₂ blanks]

[DC NO₂ blanks] lists all lab and shipment blanks.

The screenshot shows a query window titled "DC NO2 blanks : Select Query". The query diagram consists of three tables: "NO2 shipments", "NO2 tubes", and "NO2 results". "NO2 shipments" is connected to "NO2 tubes" with a 1:1 relationship. "NO2 tubes" is connected to "NO2 results". The field list table below the diagram is as follows:

Field:	batch	sid	idate	odate	abs	blnk
Table:	NO2 shipments	NO2 tubes	NO2 shipments	NO2 shipments	NO2 result:	NO2 tubes
Sort:						
Show:	<input checked="" type="checkbox"/>	<input checked="" type="checkbox"/>	<input checked="" type="checkbox"/>	<input checked="" type="checkbox"/>	<input checked="" type="checkbox"/>	<input checked="" type="checkbox"/>
Criteria:						Is Not Null
or:						

3.3 [DC NO₂ Lost tubes]

[DC NO₂ Lost tubes] lists all the samples which have measured absorbance in [NO₂ results] table but no record in the [ESamples] table.

The screenshot shows a query window titled "DC NO2 lost tubes : Select Query". The query diagram consists of three tables: "NO2 tubes", "ESamples", and "NO2 results". "NO2 tubes" is connected to "ESamples", and "ESamples" is connected to "NO2 results". The field list table below the diagram is as follows:

Field:	batch	sid	blnk	Comment	sid	abs
Table:	NO2 tubes	NO2 tubes	NO2 tube:	NO2 tube	ESamples	NO2 result
Sort:						
Show:	<input checked="" type="checkbox"/>	<input checked="" type="checkbox"/>	<input checked="" type="checkbox"/>	<input checked="" type="checkbox"/>	<input checked="" type="checkbox"/>	<input checked="" type="checkbox"/>
Criteria:			Is Null		Is Null	Is Not Null
or:						

3.4 [DC NO₂ customers], [DC NO₂ non customers]

[DC NO₂ customers] lists all NO₂ customers and their samples measured in Helsinki.

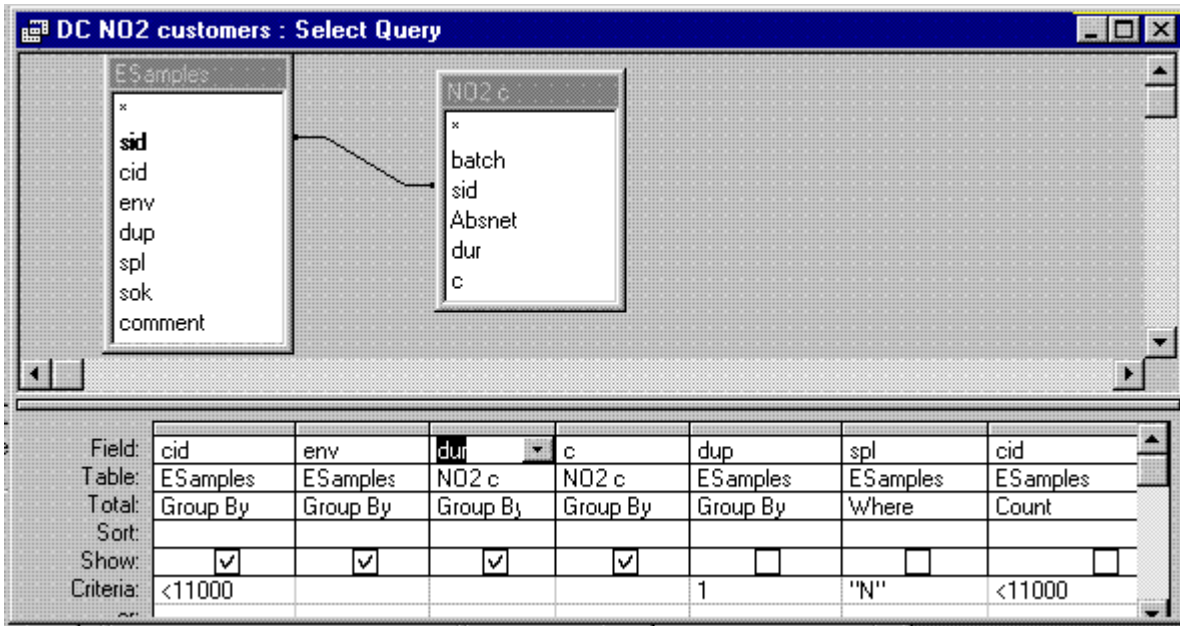

[DC NO₂ non customers] lists all samples which the database has data, but which are not Expolis measurement customers. These CIDs are microenvironmental measurements and Kuala Lumpur measurements.

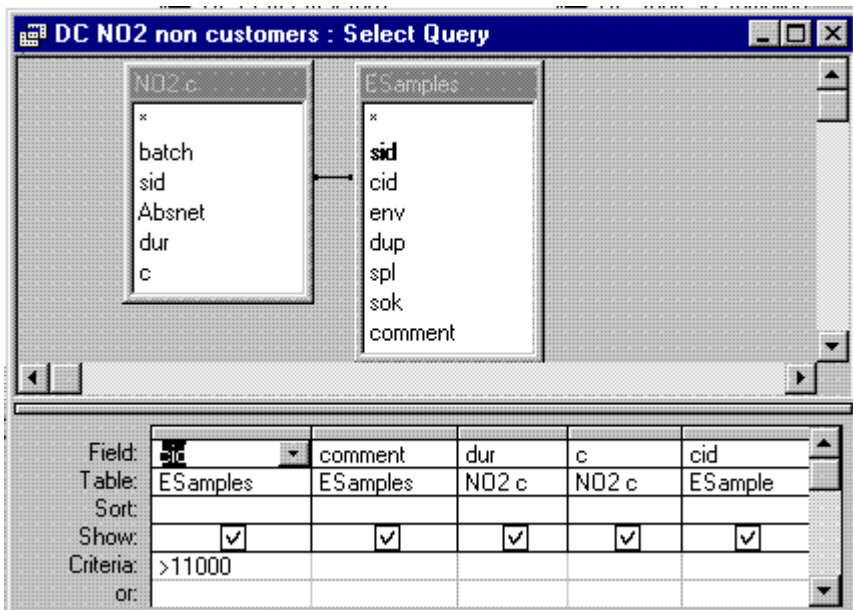

3.5 [DC NO₂ Run ok]

[DC NO₂ Run ok] lists all samples of which run has been commented (rok = 2) or rejected (rok = 3).

DC NO₂ run ok : Select Query

Field:	sid	run	rok	comment	Start	End
Table:	ERuns	ERuns	ERuns	ERuns	ERuns	ERuns
Sort:						
Show:	<input checked="" type="checkbox"/>	<input checked="" type="checkbox"/>	<input checked="" type="checkbox"/>	<input checked="" type="checkbox"/>	<input checked="" type="checkbox"/>	<input checked="" type="checkbox"/>
Criteria:			2 Or 3			
or:						

4. The Concentration Calibration Queries

This section describes all the queries used in the CQN to calculate calibrated NO₂ concentrations.

4.1 [Dur]

This query calculates the total length of sampling for each customer in hours (with decimal fractions).

The screenshot shows a Microsoft Access query design window titled "Dur : Select Query". It features two tables: "ESamples" and "ERuns". An arrow points from the "sid" field in "ESamples" to the "sid" field in "ERuns".

Field:	sid	dur: Sum(24*([End]-[Start]))	nstart: sid	MaxOfrok: Max(Abs
Table:	ESamples		ERuns	
Total:	Group By	Expression	Count	Expression
Sort:				
Show:	<input checked="" type="checkbox"/>	<input checked="" type="checkbox"/>	<input checked="" type="checkbox"/>	<input checked="" type="checkbox"/>
Criteria:				

4.2 NO₂ LabBlnkAvg]

This query calculates an average of lab blanks to each batch.

The screenshot shows a Microsoft Access query design window titled "NO2 LabBlnkAvg : Select Query". It features three tables: "NO2 shipments", "NO2 tubes", and "NO2 results". A line with a "1" and a double line with an infinity symbol connects "NO2 shipments" to "NO2 tubes". An arrow points from "NO2 tubes" to "NO2 results".

Field:	batch	LabBlnk: abs	n: abs	blnk
Table:	NO2 shipments	NO2 results	NO2 results	NO2 tubes
Total:	Group By	Avg	Count	Where
Sort:				
Show:	<input checked="" type="checkbox"/>	<input checked="" type="checkbox"/>	<input checked="" type="checkbox"/>	<input type="checkbox"/>
Criteria:				1

4.3 [NO₂ c]

This query calculates the concentration of each NO₂ sample.

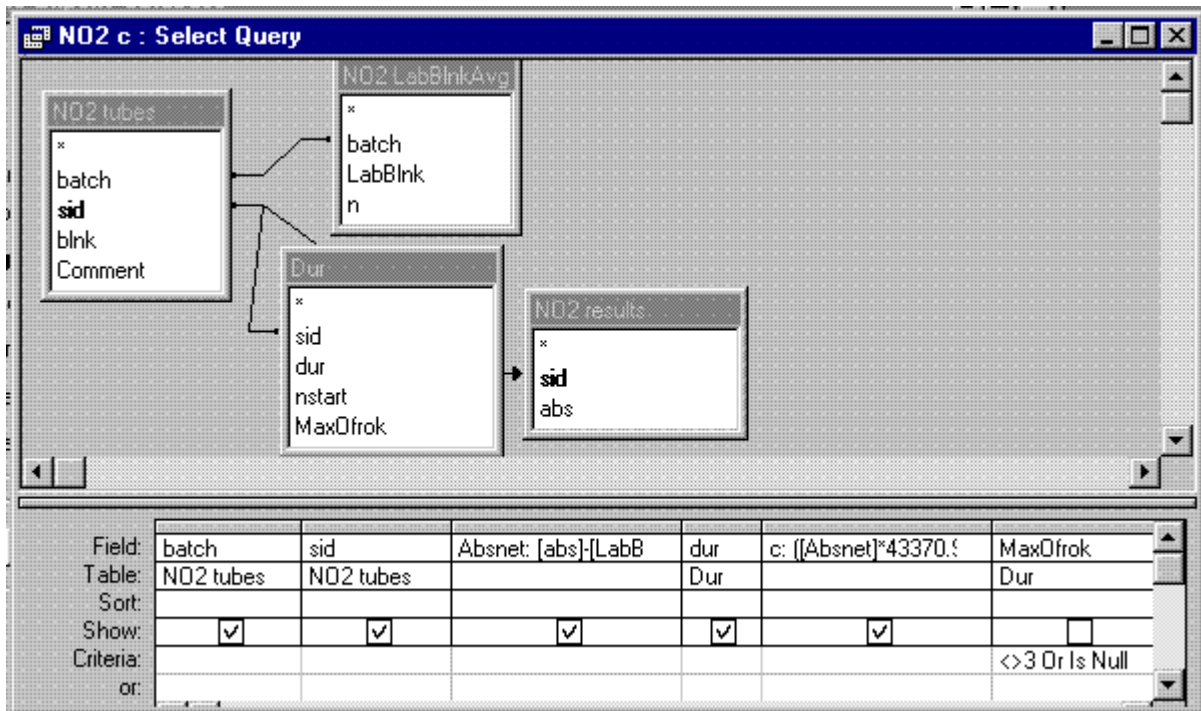

The concentration calculation is specific to the Palmes tubes used in the original *EXPOLIS* centers. In Oxford batches were used and thus the equation for c must be changed.

Equations:

$$\text{Absnet: } [\text{abs}] - [\text{LabBlnk}]$$

$$\text{c: } \frac{([\text{Absnet}] * 43370.9 - 73.74)}{[\text{dur}]}$$

5.2 [NO₂ c I]

This query combines the customer ID values with the home indoor concentrations calculated with [NO₂ c].

NO2 c I : Select Query

ESamples

- sid
- cid
- env
- dup
- spl
- sok
- comment

NO2 c

- batch
- sid
- Absnet
- dur
- c

Field:	cid	sid	I: c	dup	env
Table:	ESamples	NO2 c	NO2 c	ESamples	ESamples
Sort:					
Show:	<input checked="" type="checkbox"/>	<input checked="" type="checkbox"/>	<input checked="" type="checkbox"/>	<input type="checkbox"/>	<input type="checkbox"/>
Criteria:				1	""
or:					

5.3 [NO₂ c O]

This query combines the customer ID values with the home outdoor concentrations calculated with [NO₂ c].

NO2 c O : Select Query

NO2 c

- batch
- sid
- Absnet
- dur
- c

ESamples

- sid
- cid
- env
- dup
- spl
- sok
- comment

Field:	cid	sid	O: c	dup	env
Table:	ESamples	NO2 c	NO2 c	ESamples	ESamples
Sort:					
Show:	<input checked="" type="checkbox"/>	<input checked="" type="checkbox"/>	<input checked="" type="checkbox"/>	<input type="checkbox"/>	<input type="checkbox"/>
Criteria:				1	"0"
or:					

5.4 [NO₂ c P]

This query combines the customer ID values with personal exposure concentrations calculated with [NO₂ c]

Field:	cid	sid	P: c	dup	env
Table:	ESamples	NO2 c	NO2 c	ESamples	ESamples
Sort:					
Show:	<input checked="" type="checkbox"/>	<input checked="" type="checkbox"/>	<input checked="" type="checkbox"/>	<input type="checkbox"/>	<input type="checkbox"/>
Criteria:				1	"P"

5.5 [NO₂ c W]

This query combines the customer ID values with the workplace concentrations calculated with [NO₂ c].

Field:	cid	sid	W: c	dup	env
Table:	ESamples	NO2 c	NO2 c	ESamples	ESamples
Sort:					
Show:	<input checked="" type="checkbox"/>	<input checked="" type="checkbox"/>	<input checked="" type="checkbox"/>	<input type="checkbox"/>	<input type="checkbox"/>
Criteria:				1	"W"

5.6 [NO₂ c IOPW]

This query combines the customer ID values with the home indoor, outdoor, workplace and personal exposure concentrations calculated with [NO₂ c]

Field:	cid	I	O	P
Table:	CE Customer meas.	NO2 c I	NO2 c O	NO2 c P
Sort:				
Show:	<input checked="" type="checkbox"/>	<input checked="" type="checkbox"/>	<input checked="" type="checkbox"/>	<input checked="" type="checkbox"/>

5.7 [NO₂ duplicates]

[NO₂ duplicates] lists all main samples and duplicates of each customer ID.

Field:	cid	env	spl	dup	dup	main: c	duplicate: c
Table:	ESamples	ESamples	ESamples	ESamples	ESamples_1	NO2 c	NO2 c_1
Sort:							
Show:	<input checked="" type="checkbox"/>	<input checked="" type="checkbox"/>	<input checked="" type="checkbox"/>	<input checked="" type="checkbox"/>	<input checked="" type="checkbox"/>	<input checked="" type="checkbox"/>	<input checked="" type="checkbox"/>
Criteria:			"N"	1	2		

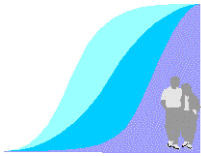

EXPOLIS

Exposure
Distributions
of Adult Urban
Populations

Documentation of the
Concentration Query Network
PM_{2.5}

Version 4 (22.5.2002, Oxford added)

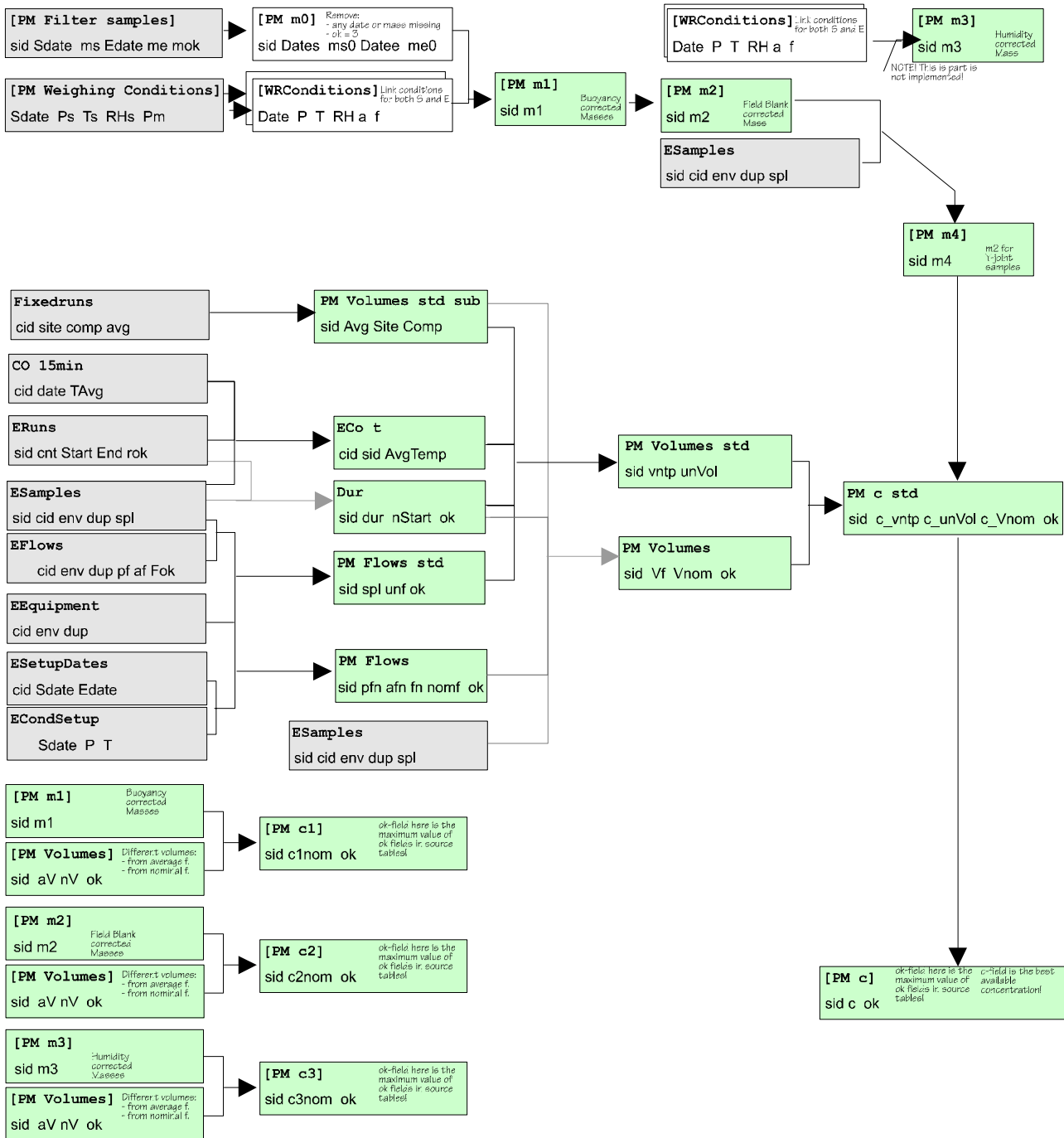

Calculating PM_{2.5} Concentrations from the *EXPOLIS* Database

Otto Hänninen, Sari Alm, Kimmo Koistinen and Esa Kaarakainen
KTL Environmental Health
P.O.Box 95
FI-70701 KUOPIO
FINLAND

The CQN described in the cover has been modified for Oxford (23.5.2002) by combining [PM Flows] with [PM Flows std] and [PM Volumes] with [PM Volumes std]. These modifications are described in the chapter for Oxford modifications. Queries were also modified to use pump type instead of the microenvironment code [env] to distinguish between 37 mm and 47 mm filters and corresponding air sampling flow rates.

Graph below: Calculating concentrations for

- P48 (time weighted average of filters P1 and P2)
- MEMs in heavy smoking microenvironments measured with two simultaneous filters and Y-joint (spl=8&9)
- 2-night MEM average concentration in Vallila homes with 2 sequential filters (spl=1&2)

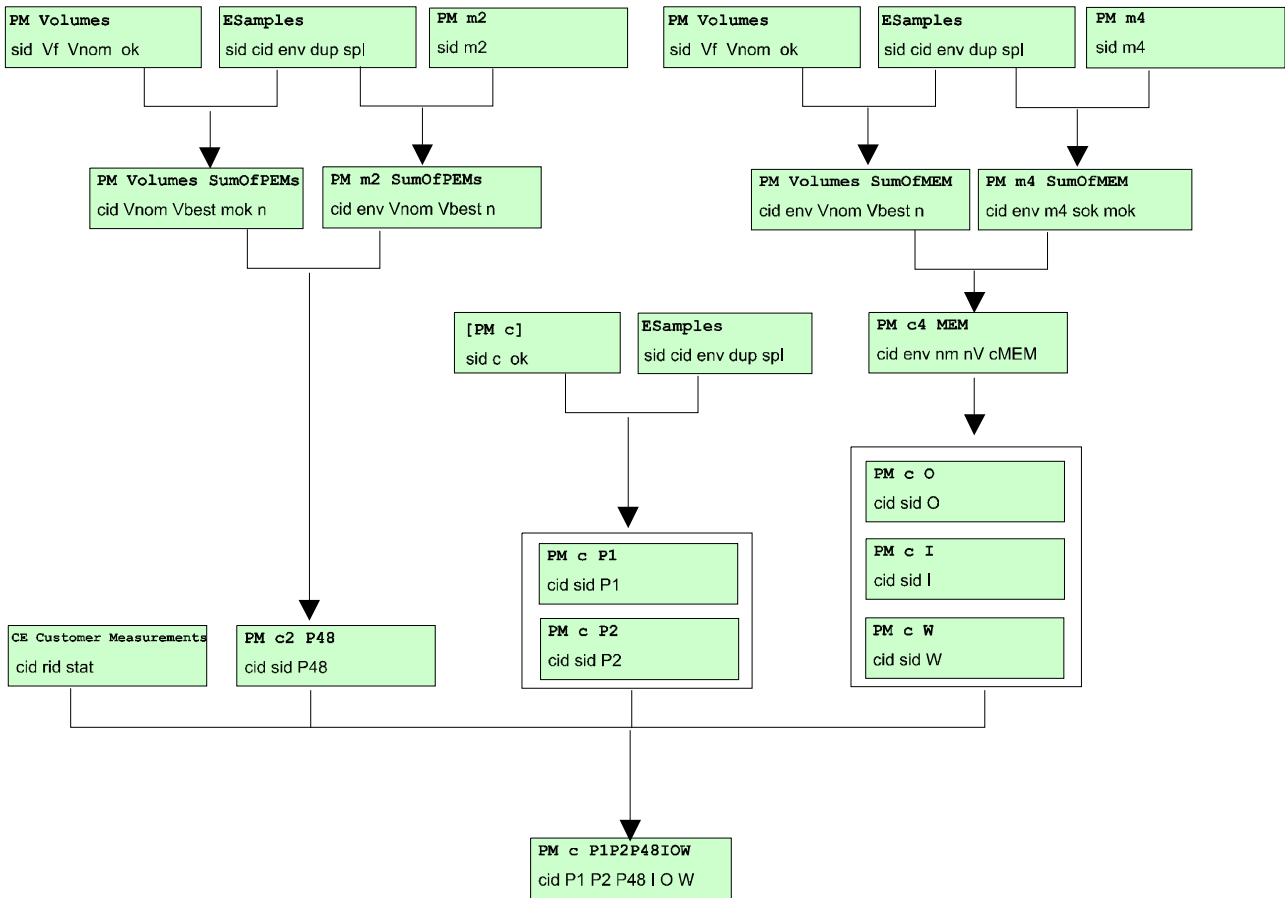

Contents

1.	INTRODUCTION	5
2.	THE STRUCTURE OF THE CQN - PM_{2.5}	6
2.1	Terms, parameters and constants used in the CQN - PM _{2.5}	6
2.2	Output Records and Data Cleaning	7
2.3	Buoyancy correction of the lab blank filter masses	7
2.4	Buoyancy and Other Corrections of Sample Filter Mass Differences	8
2.5	Air Flows During the Sampling	9
2.6	Sampling Duration	9
2.7	Sample Volume	9
2.8	Concentrations	10
3.	THE QUERIES	11
3.1	[PM blanks mb]	11
3.1.1	[PM blanks m0]	11
3.1.2	[WRConditions]	12
3.2	[PM m1]	13
3.2.1	[PM m0]	13
3.2.2	[WRConditions]	14
3.3	[PM m2]	14
3.4	[PM m3]	14
3.5	[PM m4]	15
3.6	[PM Flows]	15
3.7	[Dur]	17
3.8	[PM Volumes]	17
3.9	[PM c1]	18
3.10	[PM c2]	19
3.11	[PM c3]	19
3.12	[PM c Vnom]	20
4.	PEM VOLUME NORMALIZATION QUERIES	21
4.1	PM Flows std	21

4.2	ECo t	22
4.3	PM Volumes std sub	22
4.4	PM Volumes std	23
4.5	PM c std	23
4.6	PM c	24
5.	PM C CALCULATIONS IN MILAN AND GRENOBLE	25
5.1	Milan PM c	25
5.2	Grenoble PM c	25
6.	CONCENTRATION AGGREGATE QUERIES	31
6.1	[PM c4 MEM]	31
6.1.1	[PM m4 SumOfMEM]	31
6.1.2	[PM Volumes SumOfMEM]	32
6.2	[PM c I]	32
6.3	[PM c O]	33
6.4	[PM c W]	33
6.5	[PM c P1]	34
6.6	[PM c P2]	34
6.7	[PM c2 P48]	35
6.7.1	[PM m2 SumOfPEMs]	35
6.7.2	[PM Volumes SumOfPEMs]	36
6.8	[PM c P1P2P48IOW]	36
7.	DATA CHECKING AND CLEANING	37
7.1	[PM Summary Tables]	37
7.2	[PM Summary Masses]	38
7.3	[PM Summary Concentrations]	39
8.	WARNING ABOUT OLD QUERIES	40
8.1	Queries deleted from the 11.6.1998 version	40
8.2	Queries deleted from the 23.6.1999 version	40
8.3	Queries changed in 000601 version	40

1. Introduction

The Expolis measurement results are stored in the Expolis Access Database (EADB) in the raw format. These original data include mass readings of the balance, temperatures, relative humidities and air pressures in the weighing room, air flow calibration results from the bubble meters, measurement start and end timings etc.

The main result of these measurements are the concentrations. The concentrations are calculated from the raw data using the *Concentration Query Networks*. This document describes the structure of the CQN PM_{2.5} in general and the detailed structure of each query in the network. Similar query network will be established for the VOC and NO₂ samples in the EADB, as well as CO CQN in the CO databases (1 min, 15 min).

I hope that the Expolis database system and this concentration calculation network system ensures that we obtain corrected concentration values that are properly calculated and calculated in the same way from the raw data of each center. As this documentation shows, the calculation of a concentration is not the most trivial task.

Any comments and corrections to this crucial concentration calculation procedure are warmly welcome. I present my sincere gratitude to all that have participated in the tests, measurements, calculations, statistical analysis and discussions behind the Concentration Query Network. Let's make concentrations better!

Draft 1 16.10.1997, Version 2 11.6.1998, Version 2b 23.6.1999 Kuopio, Version 000601 Kuopio, Version 3 31.7.2000 Kuopio

ADDITIONS after 1.st draft (dated 17.10.1997)

Major/functional

- PEM PM_{2.5} 48 hour average concentration query [PM c2 P48] calculates field blank mass corrected (m₂) level average concentrations using both personal filters (1,2).
- Y-joint MEM sampling mass sums of spl=8,9 filters are calculated in [PM m4] query using [PM m2] masses
- the [PM c] query has been changed to use the [PM m4] instead of [PM m2] as input
- The OkMax() function used in CQN for PM_{2.5} did not function correctly; now the [PM c] should really have the maximum value of Ok -fields in all source tables, or -9 if any of the Ok-fields contains Null value
- Datacleaning/checking forms have been created

Minor/cosmetic

- The output of Concentration() function was changed to floating point type, as previous variant type produced text sorting. Now concentration query output numbers are correctly sorted

Still missing CQN items as of 11.6.1998

- PEM volume normalization using Langan temperature averages (to be calculated in the CO 1min database) and air pressure averages from meteorological data (to be calculated in the MET database).
 - the PEM volume normalization algorithms will be available in early autumn 1998
- hygroscopicity correction to the aerosol masses (m₃ calculation)
 - this will be added when the hygroscopicity tests have been done

[PM c] query will be changed to reflect any implemented enhancements to the CQN. Using [PM c] in data analysis queries will provide the latest/most accurate concentrations, but is subject to changes!

ADDITIONS after 2.nd version (dated 10.6.1998)

- removal of queries [PM c1 P48], [PM c IOW], [PM c IP2], [PM c WP1], [PM c1 cid IOW P48]
- finalizing the query network (queries [PM c I], [PM c O], [PM c W], [PM c P1P2P48IOW])
- new aggregate queries to handle Vallila type sequential spl=1,2 MEM filters for consecutive days

ADDITIONS after 2b version (dated 23.6.1999)

- PEM volume normalization using meteorological data and Langan temperature averages
 - Vbest, cbest created
 - Still missing: hygroscopicity correction to the aerosol masses (m₃ calculation)
-

2. The Structure of the CQN - PM_{2.5}

2.1 Terms, parameters and constants used in the CQN - PM_{2.5}

m0 Direct mass reading of the balance.

For some balance types this reading already includes some corrections of the air buoyancy, see table below.

If the buoyancy correction parameters of your center are not shown, please send the information to the author.

Center	Balance type	Buoyancy correction
Athens		?
Basel	Mettler M5	a=1.200 mg/l, ρ=8.4 g/cm ³
Grenoble		?
Helsinki	Mettler MT5	a=?..??? mg/l, ρ=8.0 g/cm ³
Milan		?
Prague		?

mb Buoyancy corrected (using true filter density) mass reading of the balance.

This is the mass of the filter plus the aerosol.

a Air density during each weighing session.

f Buoyancy factor used to calculate mb from m0 ($mb = m0 \times f$).

m1 The mass difference of the filter before and after sampling, calculated using the buoyancy corrected filter masses.

m2 m1 corrected with the field blank average contamination. The PEM and MEM filter field blank masses differ so much that this correction must be done separately for each filter size. (see also p. 14)

Center	37 mm field blank average mass [μg]	47 mm field blank average mass [μg]
Athens	4.9	19.4
Basel	1.6	16.2
Grenoble	-"-	-"- (N/A)
Helsinki	1.9	6.2
Milan	4.3	14.6
<i>Oxford</i>	<i>4.3</i>	<i>10.7</i>
Prague	22.6	26.4

m3 m2 corrected with the relative humidity mass change in the aerosol on the filter. Relative humidity corrected to 50%. (*RH % selection is a point of discussion?*) (*hygroscopicity tests missing, as of 6.6.1998*)

m4 m2 (or later m3) masses added for Y-joint MEM filters (spl=8 or 9). For non-Y-joint filters m4 = m2 (or later when hygroscopic testing has been finished, m3)

Dur Total duration of all sampling runs for each sample in hours.

Vnom Total sampled air volume calculated using the nominal flow for each equipment type. Vnom = 4.0 l/min for PEM measurements and Vnom = 16.7 l/min for MEM measurements.

Vntp	Total sampled air volume calculated using the normalized flow using temperature and air pressure of the sampling period. The starting and ending flow measurements have not normalized. Use only in PEM samples.
Vf	Total sampled air volume calculated using the average measured normalized flow. If only starting or ending flow measurement is available, it is used instead the average. Use only in MEM samples.
unvol	Total sampled air volume calculated using the unnormalized flow. If only starting or ending flow measurement is available, it is used instead the average. Use only in PEM samples.
c1, c2, c3	Concentrations calculated using the corresponding mass m1, m2, m3. Concentration calculations use the nominal flow value for each equipment type.
c_Vntp	PM2.5 concentration calculated with Vf for MEMs and Vntp for PEMs.
c_unvol	PM2.5 concentration calculated with unvol. Only for PEMs.
c_Vnom	PM2.5 concentration calculated with Vnom.
c	Best available final PM2.5 concentration with all needed corrections and normalizations done. The volumetrically controlled PEM sample flows have been corrected to NTP using the average temperature and air pressure of the sampling period. Average temperature has been extracted from the Langan Databear measurements (external temperature sensor) and the air pressure data has been obtained from a local meteorological station. For now, 6.6.1998, c is calculated from m2 level corrected m4 masses. Missing still: <ul style="list-style-type: none"> o aerosol hygroscopicity correction (m3 calculation)

2.2 Output Records and Data Cleaning

In most cases the CQN queries output only records for samples for which all the source tables/queries contain the required records. If some required source records are missing for a sample, the CQN will not output a concentration record for this sample.

It is one of the main tasks of the Data Cleaning step to ensure that all relevant records have been created in each table and that the measured data is correctly entered for these records.

2.3 Buoyancy correction of the lab blank filter masses

In the EADB there is a need to get two different kind of corrected masses:

- a) corrected masses of the filter (+ the aerosol)
 - this should be about 100 mg for the 37 mm filter and about 120 mg for the 47 mm filter
- b) corrected masses of the sampled aerosol
 - in most cases should be less than 1 mg
 - this is the mass difference between two weighings

The first part of the CQN calculates the corrected masses of lab blank filters (item a above). The second part, described in the next section, calculates the corrected mass increase of the field blanks and sample filters.

The [PM blanks m0] query calculates the date of each weighing using the int() function. The Date/time values are coded in Access so that the integer part of the value is the date proportion and the decimal part is the time portion.

The [WRConditions] query calculates the date portion of each weighing room condition measurement and calculates the daily averages of temperature, relative humidity and air pressure. This query also calculates the average daily air density from these averages, and uses it in determining the buoyancy correction factor f .

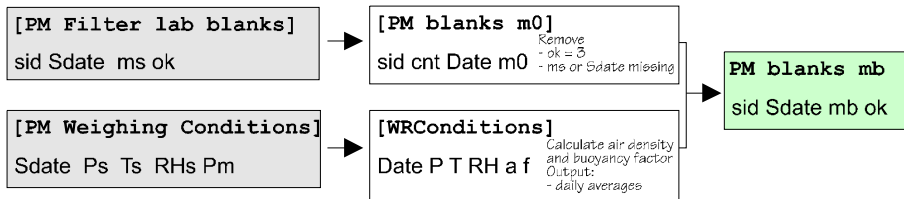

2.4 Buoyancy and Other Corrections of Sample Filter Mass Differences

The sample filter pre- and after weighings are first buoyancy corrected just like the lab blank filter masses in the previous section. As the table structure of the sample filter weighings is slightly different, a separate set of queries had to be created.

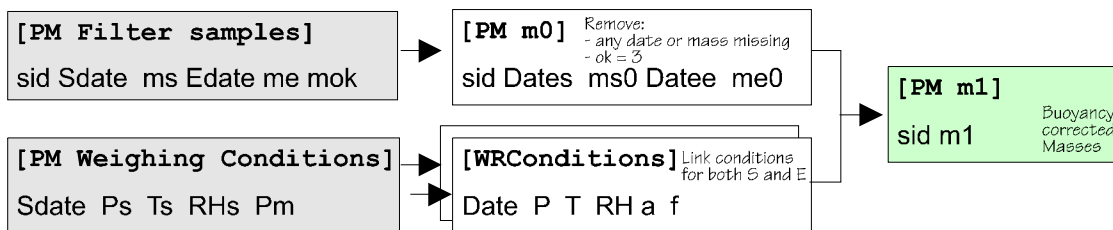

Besides the air buoyancy correction, there are two other corrections that the Helsinki data suggest that we should take into account: first, the filters are contaminated during the handling, stabilization and storage. The field blanks as well as the laboratory blanks clearly show this behavior. So the average contamination should be subtracted from the gained mass. This is done in query [PM m2].

Another correction affecting the sample filters is the humidity correction. Helsinki data of blank filters show clearly that the blank filter is not affected by the relative humidity of the weighing room. This applies at least in the relative humidity range that has prevailed in Helsinki during the Expolis weighings, which is about 5% RH - 50% RH. But the aerosol mass seems to be much more sensitive to the relative humidity in our preliminary test. Thus the observed mass difference should be corrected to known relative humidity, probably 50% RH. Note yet done (26.6.00)

Same center specific correction might apply for the weighing room humidity correction in m3.

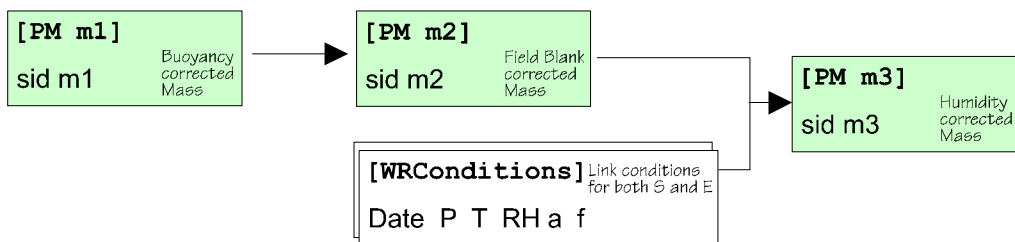

In MEM configuration when using the Y-joint sampling in smoking homes etc. polluted environments, the masses of the two filters (spl=8 and spl=9) must be summed before concentration calculation. This is done in [PM m4], which uses SQL-aggregate functions to group spl=8,9 filters together, keeping other samples alone:

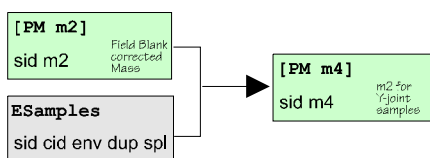

2.5 Air Flows During the Sampling

The raw air flow calibration measurements are normalized to NTP conditions. Also the nominal flow value for each sampling equipment type is calculated.

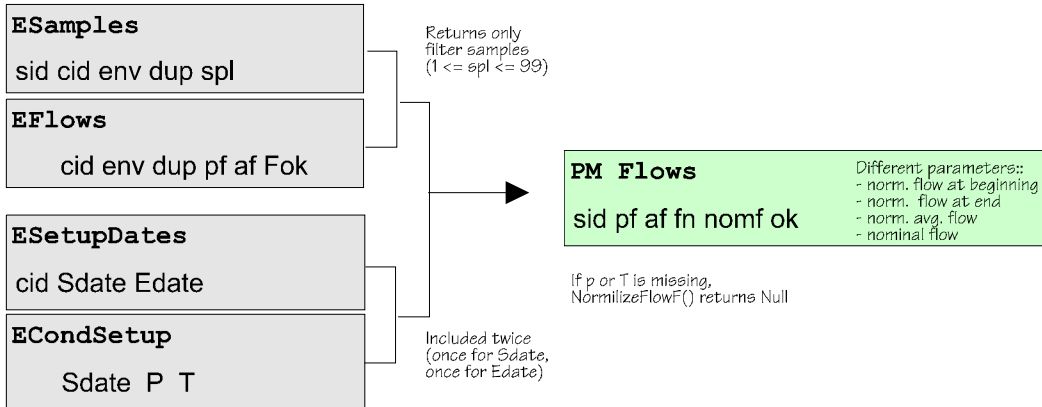

2.6 Sampling Duration

In the Expolis database several timed sampling runs can be entered for each sample. The [Dur] query calculated the total sampling length for each sample. The sampling duration is calculated in hours (with decimal fractions).

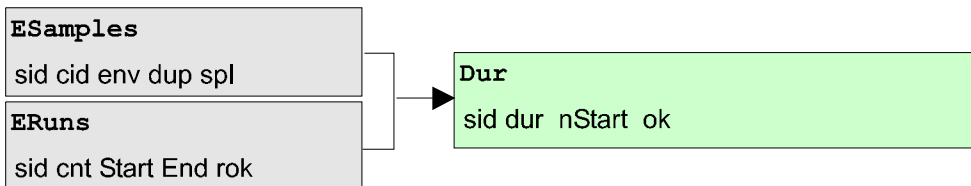

2.7 Sample Volume

In the beginning of PM calculations (1997-1998) the sampled air volume had been calculated using the nominal sampling flows. Thus the measured flows at the beginning and at the end of sampling is intended to be used only in data cleaning, in rejecting illegal values.

The MEM sampling is mass flow controlled to the NTP conditions of 760 mmHg and 20 °C. Thus the MEM volume is automatically normalized. But the PEM flow control is volumetric and the air pressure and temperature affect the real sampled volume during the sampling, and the result must be normalized to the NTP conditions. In new queries (2000) this have been done. Query PM Volumes std will take care of that, see section 4.

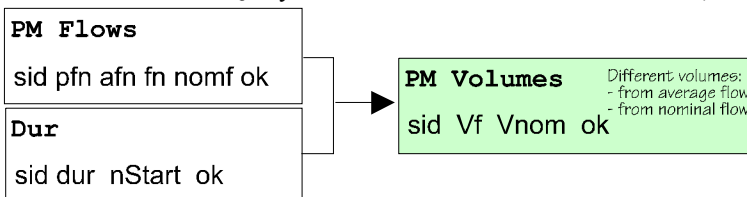

2.8 Concentrations

There are 3 levels of mass corrections/normalizations, so there will be 3 levels of concentrations (when the average flow/nominal flow volumes are not both calculated, and the PEM volume normalization is expected to be later included in the [PM Volume] query).

There is continuous need to do data viewing and preliminary analysis even before the data cleaning has finished and the parameter calculation algorithms have been fixed. To make it possible to write queries that can easily be updated later, an intermediate query is provided to show the currently selected 'correct' concentration value. This query is called [PM c] and the concentration parameter in this query is simply c. This is the query that the statistical data analyzer should be using to ensure that later when more precise data normalization procedures come available, the query results will be automatically updated.

The concentration calculations with different levels of corrections/normalization:

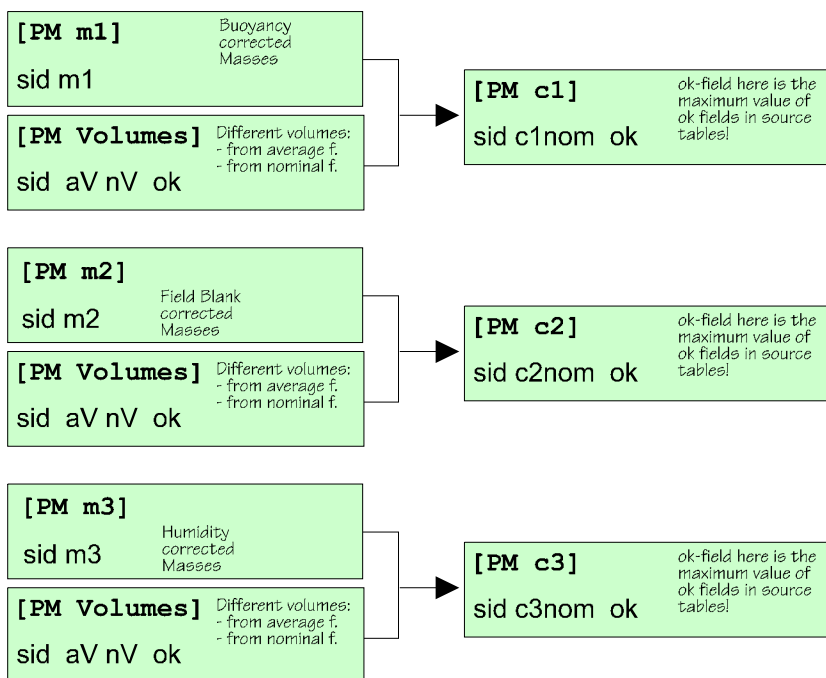

The query for user of concentration data. This query will show the latest 'correct' concentration:

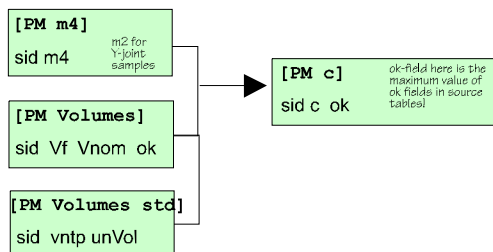

3. The Queries

This section describes all the queries used in the CQN.

Many of the query steps involve intermediate queries. These are described in a hierarchical manner below the main level query that uses them.

The names of the queries are presented in brackets, following the Access convention. Each description includes the print of the query design view from Access. The top part of these prints list the source tables/queries and the fields in these. The lower part lists the output fields, calculations and record selection criteria.

3.1 [PM blanks mb]

This query calculates the air buoyancy corrected mass of each lab blank weighing. The daily average temperature, air pressure and relative humidity are calculated from the [PM Weighing conditions] table and this daily average value is used to correct all weighings done that day.

Currently the query excludes the sample 990099, which is the Helsinki stainless steel standard weight with density of 8,0 g/cm³. The balance corrects all weighings automatically in this case. The standard weights of other centers have to be processed similarly.

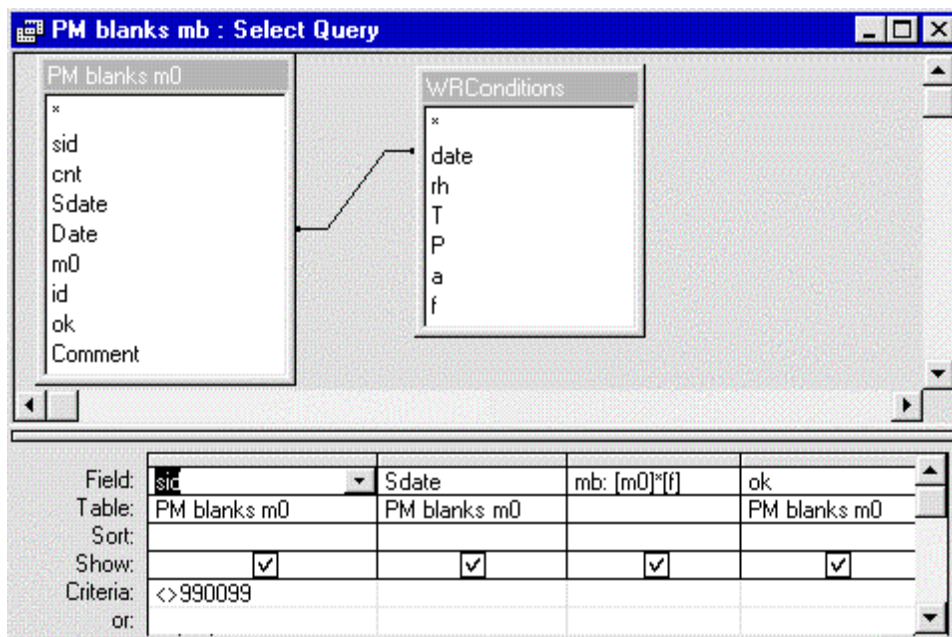

3.1.1 [PM blanks m0]

The weighing room conditions are processed as daily averages. This query will calculate the date portion of the Sdate field for each lab blank weighing. This query also exclude all weighings marked as ok=3 or records where the date, mass or ok field is Null (missing).

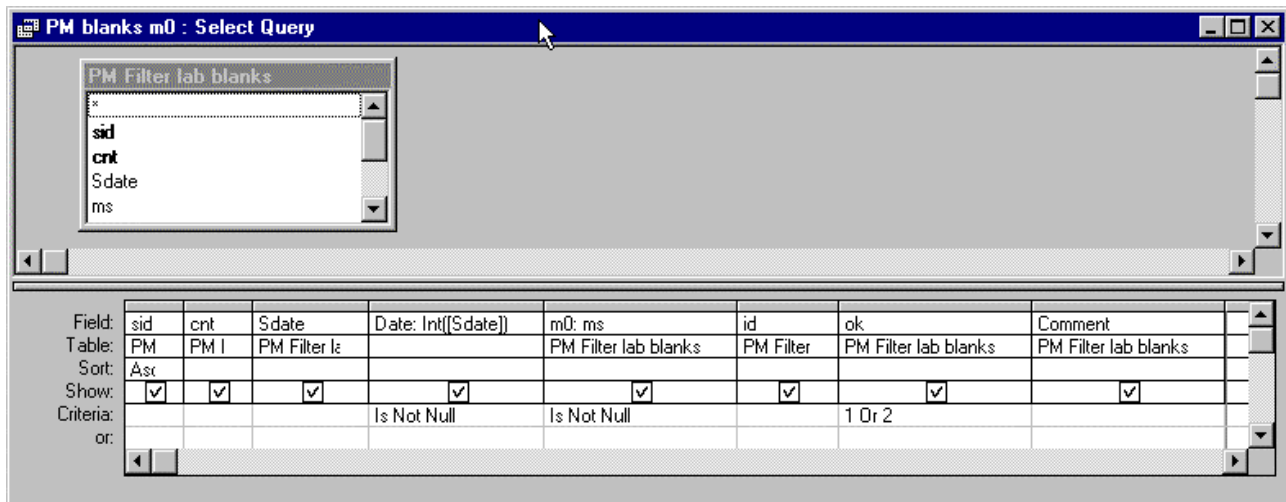

3.1.2 [WRConditions]

This query calculates the daily averages of the weighing room conditions. Also the air density and the buoyancy correction factor are calculated. Visual Basic for Applications (VBA) functions coded to calculate these are listed below.

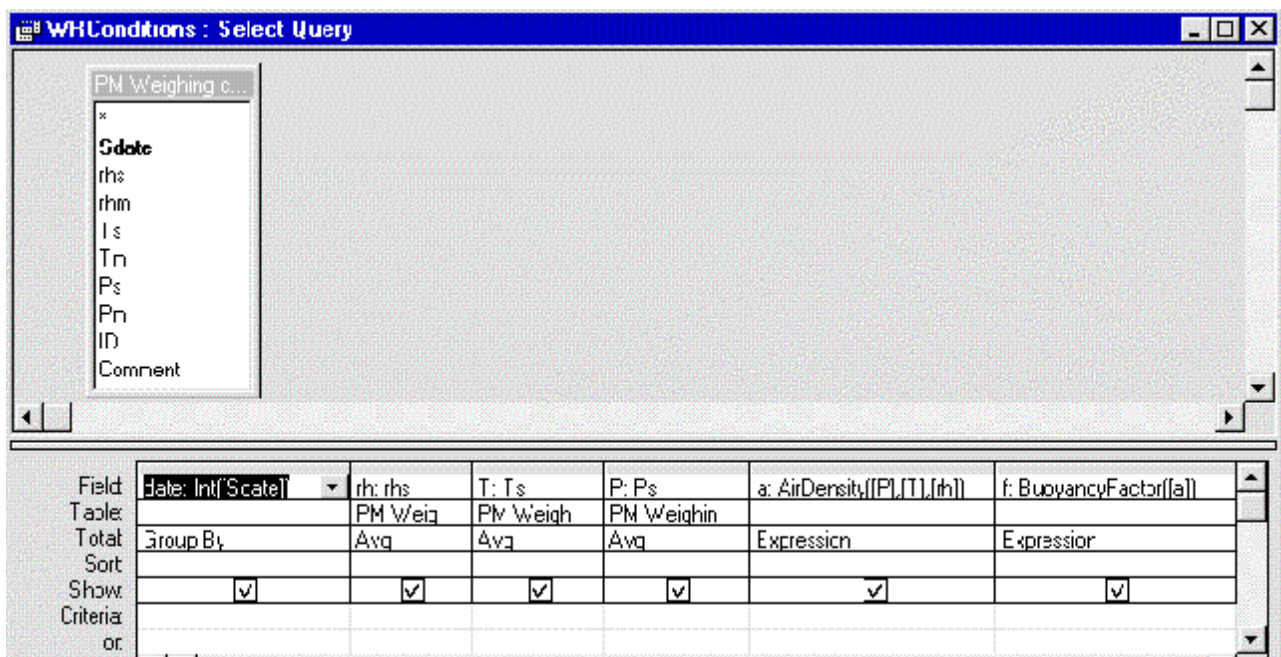

```
Public Function AirDensity(p, t, rh)
```

```
    p = p * 1.33322 ' mmHg -> hPa
```

```
    AirDensity = (0.348444 * p - (0.00252 * t - 0.020582) * rh) / (273.15 + t)
End Function
```

```
Public Function BuoyancyFactor(a)
```

```
    BuoyancyFactor = (1 - (a / 8000)) / (1 - (a / 818)) '786.4 MEM
End Function '840.x PEM
```

3.2 [PM m1]

This query calculates the buoyancy corrected mass differences of sample filters.

Output contains only records for which the corresponding weighing room condition values do exist.

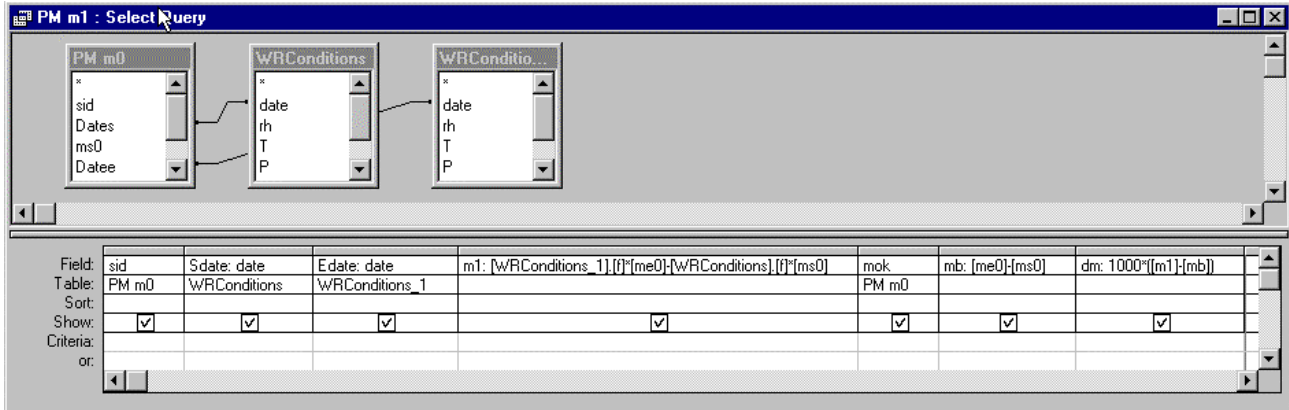

3.2.1 [PM m0]

This query calculates the date portions of weighing date/time fields and excludes sample weighing records where one of dates, masses or ok-fields is missing.

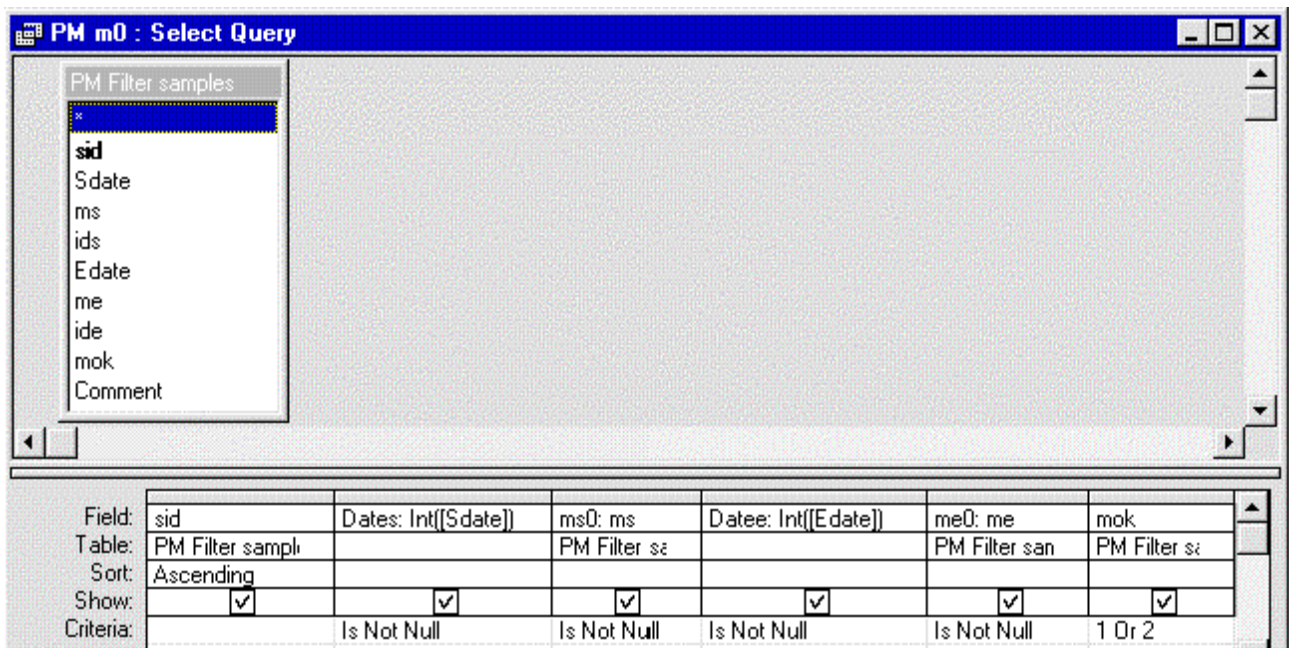

3.2.2 [WRConditions]

See section [PM blanks mb].

3.3 [PM m2]

This query applies the field blank average correction to the m1 result.

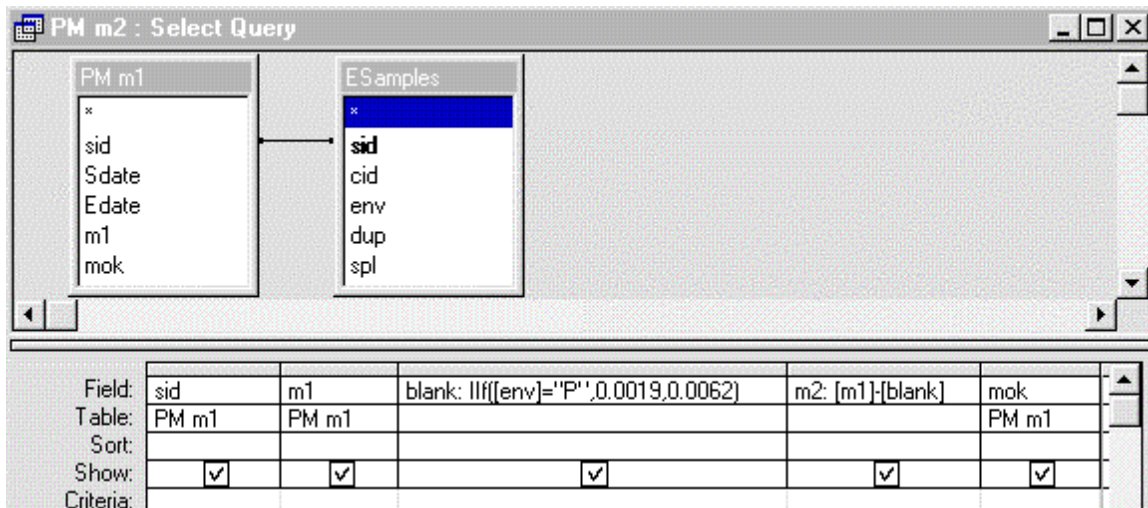

The constants for blank filter masses (contamination) used in the above query are in different cities:

City	Blank	Blank	Notes
	37 mm	47 mm	
	µg	µg	Default = Personal 37 mm, all others 47 mm
Athens	4.9	19.4	Default
Basle	1.6	16.2	Default
Grenoble	-"	-"	All samples 37 mm (47 mm filters were not used)
Helsinki	1.9	6.2	Default
Milan	4.3	14.6	Default
Oxford	4.3	10.7	Home outdoor samples 47 mm, all others 37 mm
Prague	22.6	26.4	Default

3.4 [PM m3]

This query has not been defined yet. Tests to show the dependency of aerosol mass on the relative air humidity must be carried out to get the parameters for this correction.

3.5 [PM m4]

This query is used to calculate the sum of masses for y-joint filters. Other filter samples are not affected; they will mirror the input values. As of 6.6.1998, the input is [PM m2].

Y-joint sampled filter masses are summed and the sum of masses spl=8,9 is given as m4 output. Sid will after that be same as spl=8 sid.

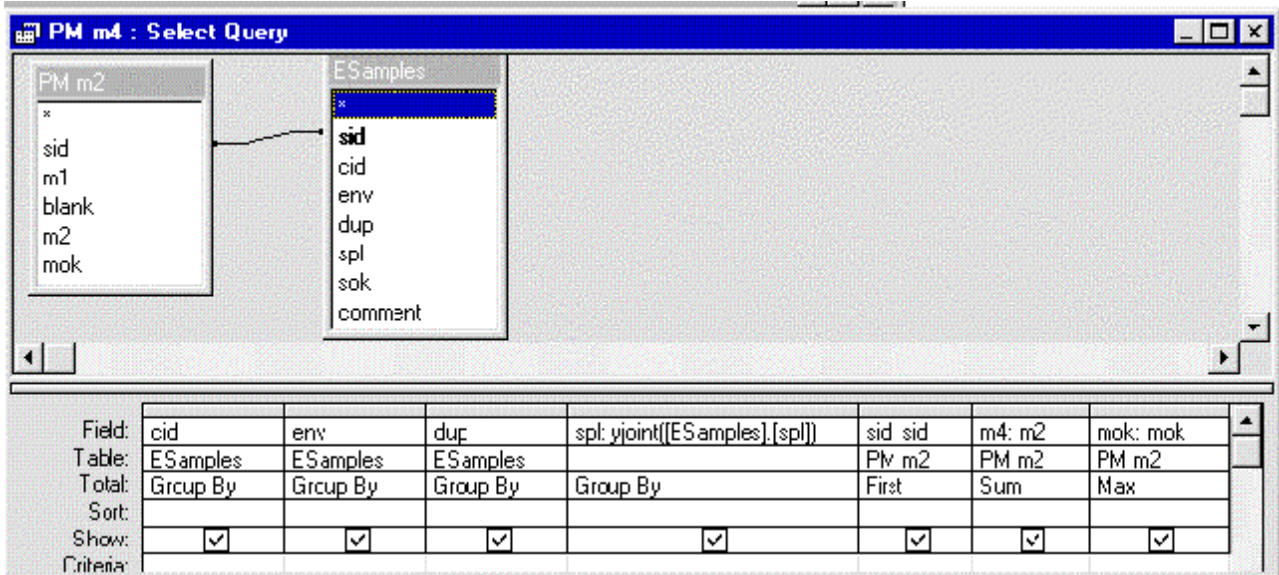

The grouping parameter in [PM m4] is calculated from the [ESamples].[spl] field using following Visual Basic function:

```
Public Function yjoint(spl)
```

```
    If spl = 9 Then yjoint = 8 Else yjoint = spl
```

```
End Function
```

3.6 [PM Flows]

This query calculates the average normalized and nominal flow of each sample. The normalized flows should be used in data cleaning, rejecting samples with illegal flows.

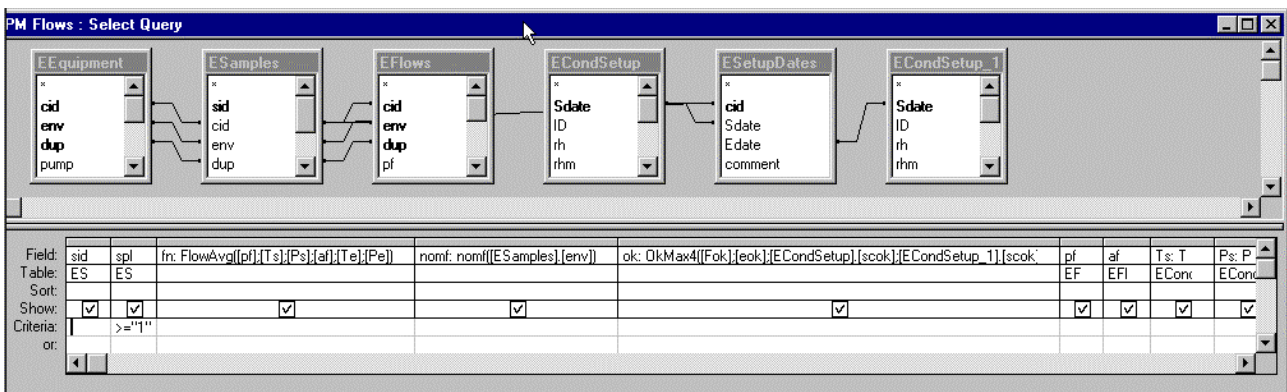

```
Public Function FlowAvg(pf, Ts As Double, Ps As Double, af, Te As Double, Pe As Double)
```

```

    If Nz(pf) = "" Then pf = -9
    If Nz(af) = "" Then af = -9

    If pf > 0 And af > 0 Then
        FlowAvg = (pf * VolF(Ts, Ps) + af * VolF(Te, Pe)) / 2
    Else
        If pf > 0 Then
            FlowAvg = pf * VolF(Ts, Ps)
        Else
            If af > 0 Then
                FlowAvg = af * VolF(Te, Pe)
            Else
                FlowAvg = Null
            End If
        End If
    End If
End Function
```

```
Public Function VolF(t As Double, p As Double)
```

```

    Dim k As Double      'k = Tn / pn
    k = 0.3857236        'Tn = 273.15 + 20 K    pn = 760 mmHg

    If t = -9 Or p = -9 Then
        VolF = 1
    ElseIf t > 0 And p > 0 Then
        VolF = p / (t + 273.15) * k
    Else
        VolF = Null
    End If
End Function
```

```
End Function
```

```
Public Function OkMax(i, j) As Integer
```

```

    If Nz(i) = "" Then      ' if first parameter is Null
        OkMax = -9         ' return -9
    ElseIf Nz(j) = "" Then  ' or second parameter is Null
        OkMax = -9         ' return -9
    ElseIf Int(i) > 0 And Int(j) > 0 Then ' if both parameters are >0
        If i > j Then
            OkMax = i
        Else
            OkMax = j
        End If
    Else
        OkMax = -9         ' if parameters are something else, return -9
    End If
End Function
```

3.7 [Dur]

This query calculates the total length of sampling for each sample in hours (with decimal fractions). The output also counts the runs.

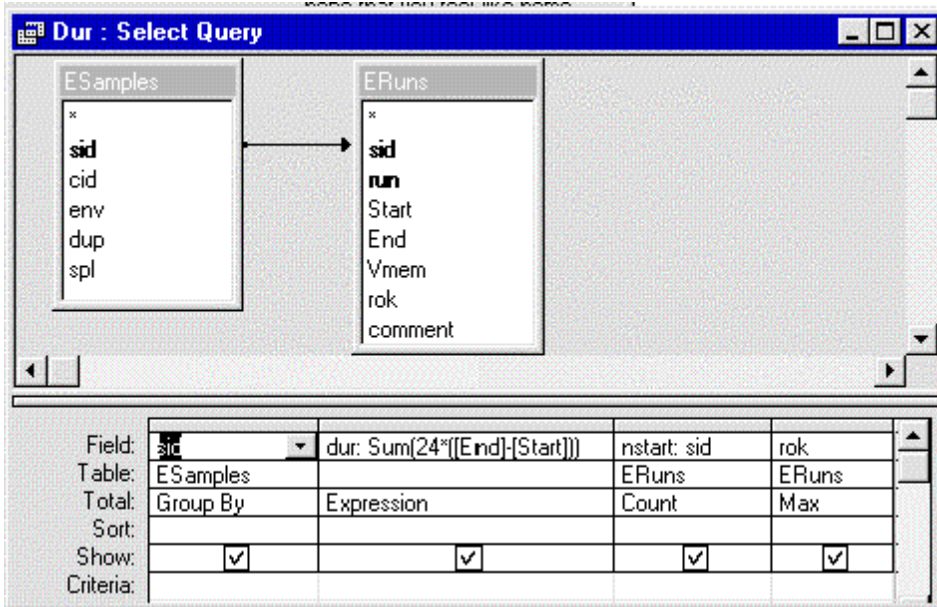

3.8 [PM Volumes]

This query calculates the total normalized (Vf) and nominal (Vnom) sampled air volume for each sample. Changed 16.3.2000, added procedure to determine unVol, Vntp and the best volume VBest. See more section 4 (PM Volume std).

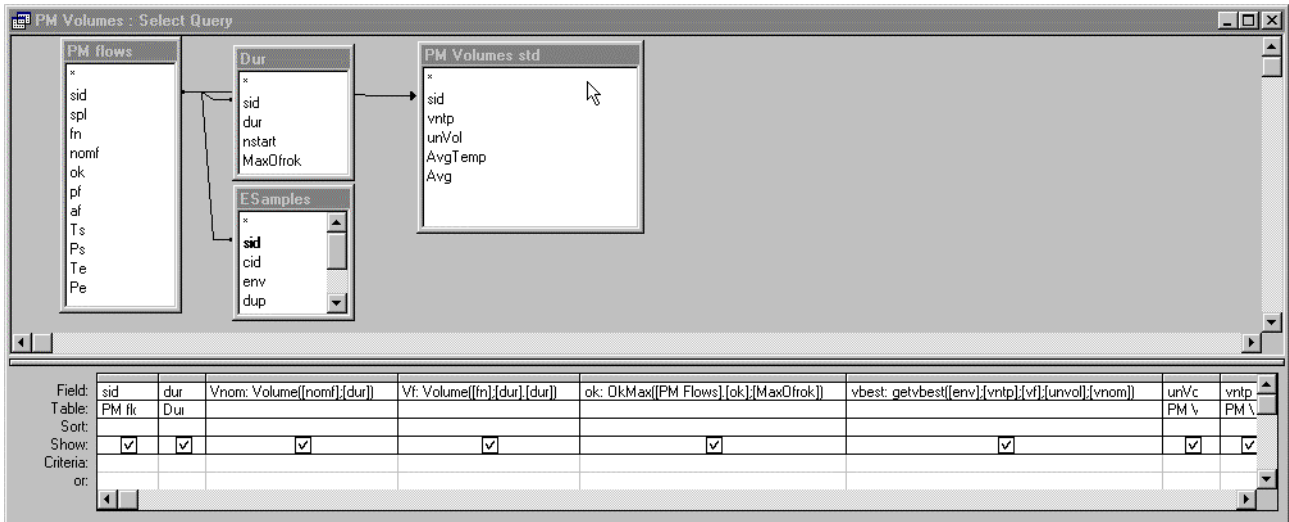

Vnom is counted using function Volume in ExpolisNormalize –module:

```
Public Function volume(flow, dur) As Single
    If flow >= 0 And dur >= 0 Then
        volume = flow * dur * 60 / 1000 ' l/min *60 -> l/h, 1/1000 -> m3
    Else
        volume = -9
    End If
End Function
```

Vbest is determined with function *getVbest* in *ExpolisPMStd* -module:

```
Public Function getVbest(env As String, vnntp As Variant, vf As Variant, unvol As Variant,
vnom As Variant) As Double

If env = "p" Then
  If (IsNull(vnntp) = False) And (vnntp <> -9) Then
    getVbest = vnntp
  Else
    If (IsNull(unvol) = False) And (unvol <> -9) Then
      getVbest = unvol
    Else
      If (IsNull(vnom) = False) And (vnom <> -9) Then
        getVbest = vnom
      Else
        getVbest = -9
      End If
    End If
  End If
Else
  If (IsNull(vf) = False) And (vf <> -9) Then
    getVbest = vf
  Else
    If (IsNull(vnom) = False) And (vnom <> -9) Then
      getVbest = vnom
    Else
      getVbest = -9
    End If
  End If
End If

End Function
```

3.9 [PM c1]

This query calculates the concentrations using buoyancy corrected masses and nominal sampled volumes calculated in [PM Volumes] query.

Field:	Table:	Criteria:
c1nom: Concentration([m1].[Vnom])	PM Volumes	
ok: OkMax([PM Volumes].[ok].[mok])		

3.10 [PM c2]

This query calculates the concentrations using buoyancy and field blank corrected masses and nominal sampled volumes calculated in [PM Volumes] query.

Field:	Table:	Criteria:
sid	PM Volumes	
c2nom: Concentration([m2].[Vnom])		
ok: OkMax([PM Volumes].[ok],[mok])		
Show:	<input checked="" type="checkbox"/>	<input checked="" type="checkbox"/>
Criteria:		

3.11 [PM c3]

This query is still under construction. Tests to show the dependency of aerosol mass on the relative air humidity must be carried out to get the parameters for m3 and c3 calculation.

3.12 [PM c Vnom]

THIS QUERY WAS PREVIOUSLY [PM c]. See section 4 for closer details. Changed in version 000601.

This is the endpoint query of concentration calculations for each filter.

When the corrections needed to calculate the correct results are updated, eg. new queries entering the network, this query will be updated too to use the concentration from the latest calculation algorithm.

When user specifically wants to use one of the c1, c2, c3 level of concentrations, then she/he should directly link to that query ([PM c1], [PM c2], [PM c3]). When the 'correct' concentration is needed, with all relevant corrections done, then she/he should link to the [PM c] query. The data manager will inform all users when the definition of [PM c] changes.

As of 6.6.91998, [PM c] calculates the concentration using m2/m4 masses (field blank corrected masses, summing Y-joint filter results together).

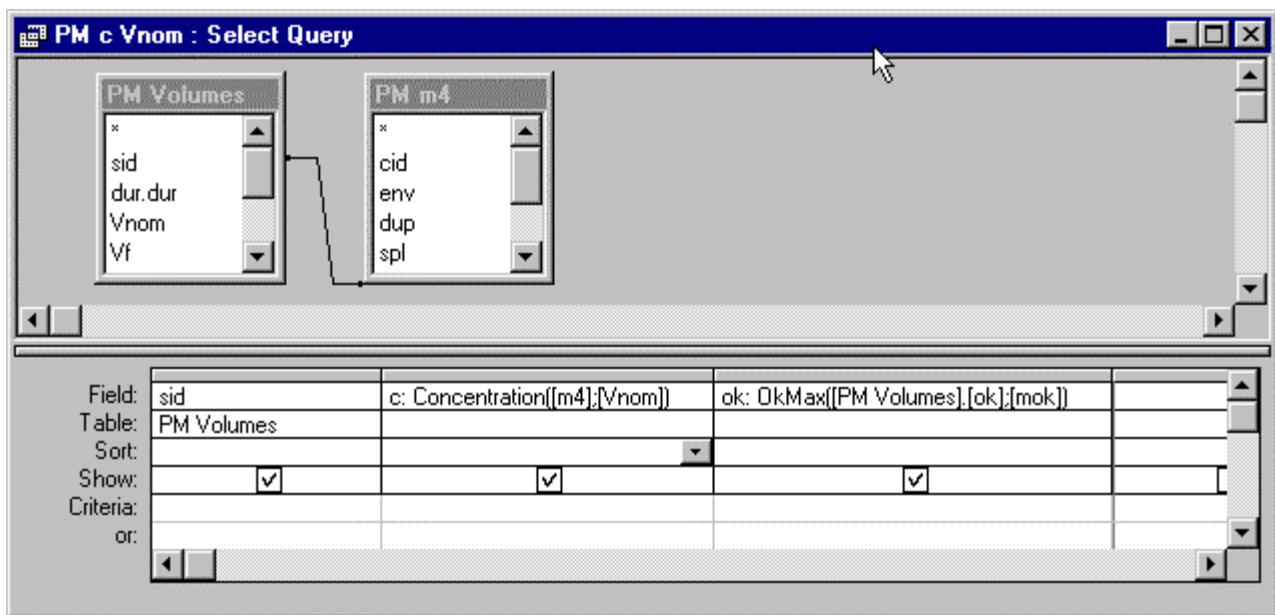

4. PEM volume normalization queries

Following queries have been created and changed during winter 99-00. These queries do the PEM volume normalization using meteorological data and Langan temperature averages.

4.1 PM Flows std

This query calculates unnormalized flow, **unf** for each sample using flows measured before and after measurement.

Field:	sid	spl	unf: FlowAvgUnf([pf],[af])	ok: OkMax4([Fok];[eok];[ECondSetup].[scok];[ECondSetup_1].[scok])
Table:	ESample	ESamples		
Sort:				
Show:	<input checked="" type="checkbox"/>	<input checked="" type="checkbox"/>	<input checked="" type="checkbox"/>	<input checked="" type="checkbox"/>
Criteria:		>="1" And <"99"		
or:				

Following function determines which flow (af or pf) will be used for unf.

Function FlowAvgUnf

```
Public Function FlowAvgUnf(pf As Variant, af As Variant)
' Modified 26.10.1999 eKa
' Parameter types (pf, af) changed from double to variant
' otherwise function returns #error if both are null
    If IsNull(pf) Then pf = -9
    If IsNull(af) Then af = -9

    If (af > 0) And (pf > 0) Then
        FlowAvgUnf = (pf + af) / 2
    Else
        If (af > 0) Then
            FlowAvgUnf = af
        Else
            If (pf > 0) Then
                FlowAvgUnf = pf
            Else
                FlowAvgUnf = Null
            End If
        End If
    End If
End Function
```

4.2 ECo t

This query calculates average temperature for each personal PM sample from Langan temperature measurement.

The screenshot shows a query window titled "ECo t : Select Query". It features a query diagram with three tables: "CO 15min", "ESamples", and "ERuns". Arrows indicate relationships between fields in these tables. Below the diagram is a table defining the query's fields and criteria.

Field:	cid	sid	AvgTemp: T#	prStDev: T#	prMin: T#vc	prMax: TA	n: date	date	env	spl
Table:	CO 1	ESam	CO 15min	CO 15min	CO 15min	CO 15min	CO 15r	CO 15min	ESam	ESamples
Total:	Grou	Gro	Avg	StDev	Min	Max	Count	Where	Where	Where
Sort:										
Show:	<input checked="" type="checkbox"/>	<input checked="" type="checkbox"/>	<input checked="" type="checkbox"/>	<input checked="" type="checkbox"/>	<input checked="" type="checkbox"/>	<input checked="" type="checkbox"/>	<input checked="" type="checkbox"/>	<input type="checkbox"/>	<input type="checkbox"/>	<input type="checkbox"/>
Criteria:								>=[start] And <[end]	"P"	>="1" And <"99"
or:										

4.3 PM Volumes std sub

This query gets air pressure for each sid from Fixedruns -table. Criterias Site and Comp must be updated for each centre.

The screenshot shows a query window titled "PM Volumes std sub : Select Query". It features a query diagram with one table: "Fixedruns". Below the diagram is a table defining the query's fields and criteria.

Field:	sid	Avg	Site	Comp
Table:	Fixedruns	Fixedruns	Fixedruns	Fixedruns
Sort:				
Show:	<input checked="" type="checkbox"/>	<input checked="" type="checkbox"/>	<input type="checkbox"/>	<input type="checkbox"/>
Criteria:			"hkiva"	"pres"
or:				

4.4 PM Volumes std

This query calculates values for **vn_{tp}** (from **unf**, **dur** and measurement period **T** and **p** normalization) and **unVol** (from **unf** and **dur**).

Field:	sid	dur	vn _{tp} : IIf(IsNull([PM Volumes std sub].[sid]) Or IsNull([ECo t].[sid]);-9:Volume([unf],[dur],[dur])*volF([AvgTemp],[avg]*0.75006))	unVol: volume([unf],[dur],[dur])	AvgTemp
Table:	PM Fl	Dur			ECo t
Sort:					
Show:	<input checked="" type="checkbox"/>	<input checked="" type="checkbox"/>	<input checked="" type="checkbox"/>	<input checked="" type="checkbox"/>	<input checked="" type="checkbox"/>
Criteria:					
or:					

```

Public Function VolF(t As Double, P As Double)
    Dim k As Double    'k = Tn / pn
    k = 0.3857236      'Tn = 273.15 + 20 K    pn = 760 mmHg

    If t = -9 Or P = -9 Then
        VolF = 1
    ElseIf t > 0 And P > 0 Then
        VolF = P / (t + 273.15) * k
    Else
        VolF = Null
    End If

End Function
    
```

4.5 PM c std

This query calculates different concentrations using different volumes. Next query, **PM c** then selects the best available concentration.

Field:	sid	c_vn _{tp} : IIf([env]="P" And IsNull([PM Volumes std].[sid])=False:Concentration([m4],[vn _{tp}]);IIf([env]="P" And IsNull([PM Volumes std].[sid])=True;-9:Concentration([m4],[vf]))	c_unVol: IIf([er-
Table:	PM		
Sort:	Asc		
Show:	<input checked="" type="checkbox"/>	<input checked="" type="checkbox"/>	<input checked="" type="checkbox"/>
Criteria:			
or:			

```

c_vntp: c_vntp: IIf([env]="P" And IsNull([PM Volumes
std].[sid])=False;Concentration([m4],[vntp]);IIf([env]="P" And
IsNull([PM Volumes std].[sid])=True;-9;Concentration([m4],[vf]))
c_unVol: IIf([env]="P" And IsNull([PM Volumes
std].[sid])=False;Concentration([m4],[unVol]);-9)
c_Vnom: Concentration([m4],[Vnom])
ok:      OkMax([PM Volumes].[ok],[mok])
    
```

4.6 PM c

This is the endpoint query of concentration calculations for each filter. Old [PM c] has been renamed to [PM c Vnom]. PM c is the best available concentration, order is: 1st c_vntp, 2nd c_unVol, 3rd c_Vnom.

The screenshot shows a 'PM c : Select Query' dialog box. On the left, a list of fields is displayed: 'PM c std', 'x', 'sid', 'c_vntp', 'c_unVol', 'ok', 'c_Vnom', and 'env'. Below this list is a table with the following structure:

Field:	sid	c: If([c_vntp]<>-9:[c_vntp]:If([c_unVol]<>-9:[c_unVol]:c_vnom))	c_vntp	c_unVol	c_Vnom	ok
Table:	PM c std		PM c std	PM c std	PM c std	PM c std
Sort:						
Show:	<input checked="" type="checkbox"/>	<input checked="" type="checkbox"/>	<input checked="" type="checkbox"/>	<input checked="" type="checkbox"/>	<input checked="" type="checkbox"/>	<input checked="" type="checkbox"/>
Criteria:						

5.3 Oxford

The volume calculation queries were updated for Oxford data. In Oxford only samples in home outdoors were collected with PQ100 pump using 47-mm filters and nominal airflow of 16.7 Lpm. All other samples (home indoors, workplace and personal) were collected using Buck I.H. pump, 37 mm filters and nominal airflow of 4.0 Lpm. Thus the airflow calculation and selection of volume normalization for volumetric Buck I.H. air samples could not be based on the microenvironment in the same way as in the case of most other *EXPOLIS* centers.

The table [EEquipment] field [pump] was selected to indicate the type of sampling pump used. The field values are like P01 for PQ100 and B01 for Buck pumps (the number being unique piece of equipment identifier). Volumetric sampling and normalization of flows were used for pumps starting with letter "B" and gravimetric flow control with no normalization was assumed for pumps starting with "P".

Some of the queries in the EADBTOOL.mdb (as of 20.5.2002) were combined to clarify the query network structure:

PM Flows + PM Flows sdt	were combined into	PM Flows
PM Volumes + PM Volumes std	were combined into	PM Volumes

After this the functionality of the queries and the fields (variables) used in the calculations are

Query	Parameters			VBA Functions	Notes
PM Flows	nomf			nomf	Nominal flow (4 or 16.7 Lpm)
		unf		flowavgunf	Un-normalized flow (for volumetric pump)
			fn	flowavg, volf	Normalized flow (for gravimetric pump)
PM Volumes	vnom				dur x nomf
		unVol			dur x unf
			vf		dur x fn
		vntp		ntpv	dur x unf x volf(...)
PM m4	m4				
PM c std	c_vnom			concentration	
		c_unvol		concentration	
			c_vntp	concentration	
PM c	3	2	1		Selects the best available concentration (assumes missing=-9)

Equations used in the concentration calculation are

c	MEM	PEM
1	$c_ntp = m4 / (dur \times vf)$	$c_ntp = m4 / (dur \times vntp)$
2	N/A (-9)	$c_unvol = m4 / (dur \times unf)$
3	$c_vnom = m4 / (dur \times nomf)$	$c_vnom = m4 / (dur \times nomf)$

The modified PM_{2.5} CQN is described below.

5.3.1 [PM m2] (affecting [PM m4])

The field blank correction changed to use local values for the 37 mm and 47 mm filters and to take into account the fact that all other than home outdoor ("O") samples were 37 mm type.

5.3.2 PM Flows

May 2002 version of [PM Flows] query combines the functionality of [PM Flows std]. The [pump] –field from the [EEquipment] table is included for the selection of the volume normalization.

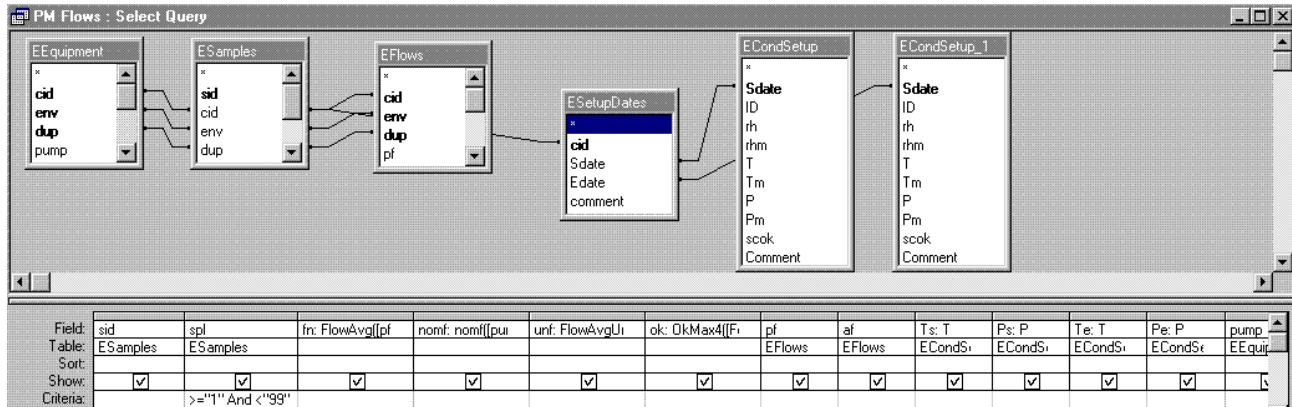

Equations:

- fn:** FlowAvg([pf],[Ts],[Ps],[af],[Te],[Pe])
- nomf:** nomf([pump])
- unf:** FlowAvgUnf([pf],[af])
- ok:** OkMax4([Fok],[eok],[ECondSetup].[scok],[ECondSetup_1].[scok])

The function **nomf** was modified to use the 1st letter of the [pump] field instead of the [env] field to determine the nominal flow. The function **FlowAvgUnf** was moved from module ExpolisPMStd to the module ExpolisNormalize (where the other functions used here were already).

```

Public Function nomf (typ)
    If Left (typ, 1) = "P" Then
        nomf = 16.7
    ElseIf Left (typ, 1) = "B" Then
        nomf = 4
    Else
        nomf = Null
    End If
End Function
    
```

MODIFIED FUNCTION

```

' OH 21.5.2002 modified for Hak Kan
' this comparison is case unensitive
    
```

5.3.3 PM Volumes

The functionality of query [PM Volumes std] was added to this query.

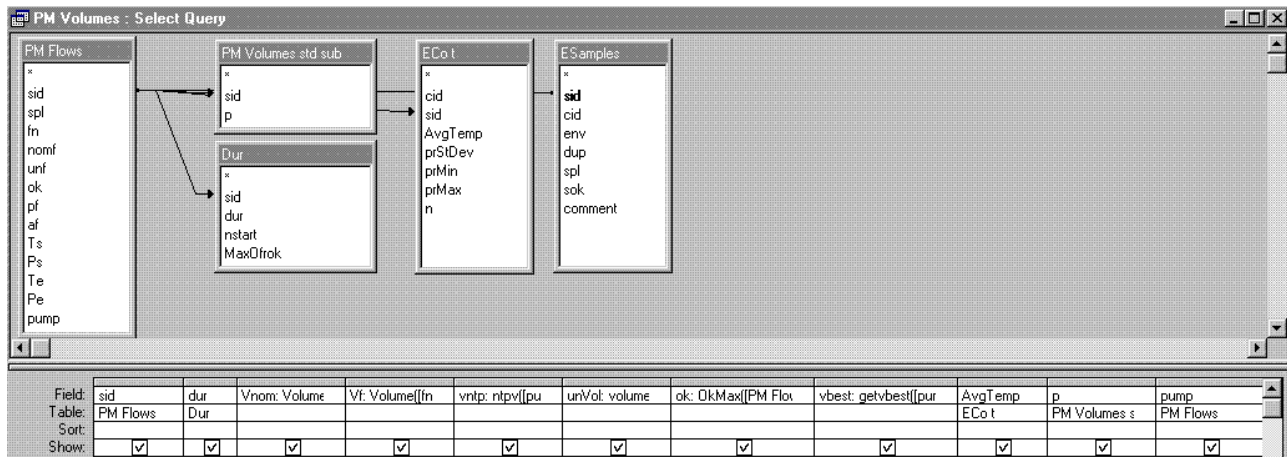

Equations:

```

Vnom:    Volume([nomf],[dur])
Vf:     Volume([fn],[dur])
vntp:    ntpv([pump],[avgtemp],[p],Volume([unf],[dur]))
unVol:   volume([unf],[dur])
ok:     OKMax([PM Flows],[ok],[MaxOfrok])
vbest:  getvbest([pump],[vntp],[vf],[unvol],[vnom])
  
```

```

Public Function volume(flow, dur) As Single                                NO MODIFICATIONS!
    If flow >= 0 And dur >= 0 Then
        volume = flow * dur * 60 / 1000 ' l/min *60 -> l/h, 1/1000 -> m3
    Else
        volume = -9
    End If
End Function
  
```

The new function **ntp** was written to replace immediate-if statements. The original functionality was changed so that instead of outputting missing code (-9) for cases where the PEM temperature data is missing (e.g. Oxford home indoor and workplace measurements) the default temperature of 20°C is used.

```

Public Function ntpv(typ As String, t, mb, v)                                NEW FUNCTION
    ' PEM volumetric sample conversion to NTP (Oxford/Hak Kan)
    ' original statement from query [PM Volume std] below:
    ' IIf( IsNull([p]) Or (IsNull([AvgTemp])),
    '     -9,
    '     Volume([unf],[dur]) * volf([AvgTemp],[p]*0.75006) )
    Dim td As Double, ntpf

    If Len(Nz(t)) = 0 Then td = 20 Else td = t ' use 20°C as default if true
    temperature data is missing
    If Len(Nz(mb)) > 0 And mb > 0 Then ntpf = volf(td, mb * 0.75006) Else ntpf
    = Null

    ' output is missing (-9) if
    ' - pump is mass flow controlled ("P")
    ' - volume is missing (-9 or Null)
    ' - ntp-factor is missing (pressure is missing (Null))
    If Left(typ,1)="B" And v>0 And ntpf>0 Then ntpv = ntpf * v Else ntpv = -9
End Function
  
```

The **getVbest** function was modified to use the 1st letter of the [pump] field, instead of the [env] field, to select the correct volume calculation result.

```

Public Function getVbest(pump As String, vnntp As Variant, vf As Variant,
unvol As Variant, vnom As Variant) As Double

If Left(pump, 1) = "B" Then ' volumetric pump (Buck IH)
  If (IsNull(vnntp) = False) And (vnntp <> -9) Then
    getVbest = vnntp
  Else
    If (IsNull(unvol) = False) And (unvol <> -9) Then
      getVbest = unvol
    Else
      If (IsNull(vnom) = False) And (vnom <> -9) Then
        getVbest = vnom
      Else
        getVbest = -9
      End If
    End If
  End If
End If

Else ' mass flow controlled pump (PQ100)
  If (IsNull(vf) = False) And (vf <> -9) Then
    getVbest = vf
  Else
    If (IsNull(vnom) = False) And (vnom <> -9) Then
      getVbest = vnom
    Else
      getVbest = -9
    End If
  End If
End If

End Function
    
```

5.3.4 PM c std

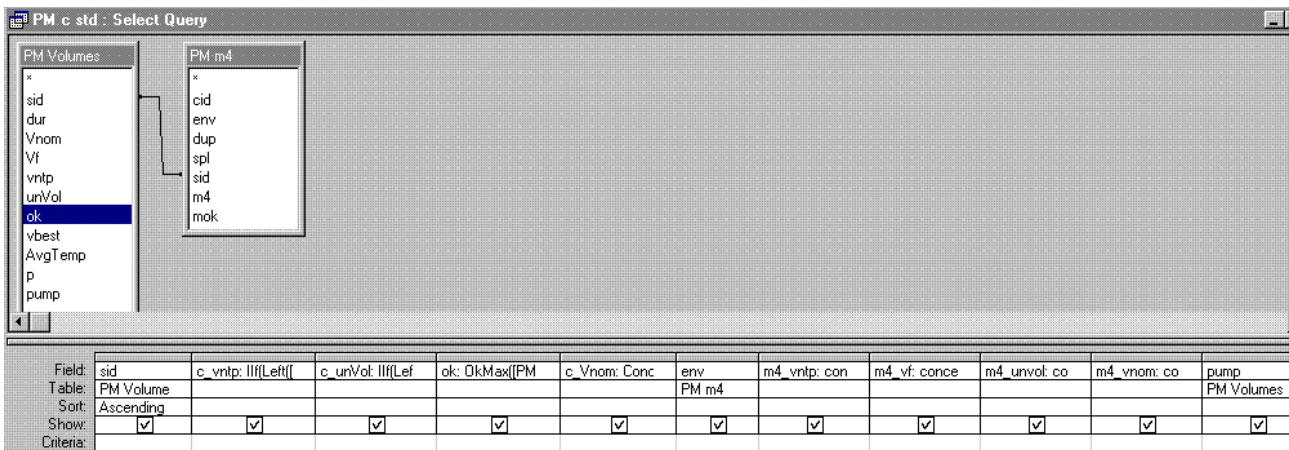

Equations:

- c_vntp:** IIf(Left([pump],1)="B",Concentration([m4],[vnntp]),Concentration([m4],[vf]))
- c_unVol:** IIf(Left([pump],1)="B",Concentration([m4],[unVol]),-9)
- ok:** OkMax([PM Volumes].[ok],[mok])
- c_Vnom:** Concentration([m4],[Vnom])
- m4_vntp:** concentration([m4],[vnntp])
- m4_vf:** concentration([m4],[vf])
- m4_unvol:** concentration([m4],[unvol])
- m4_vnom:** concentration([m4],[vnom])

5.3.5 PM c (not modified)

Field:	sid	c: If([c_vntp]<>9,[c_vntp],If([c_unVol]<>9,[c_unvol],[c_vnom]))	c_vntp	c_unVol	c_Vnom	ok
Table:	PM c std		PM c std	PM c std	PM c std	PM c std
Sort:						
Show:	<input checked="" type="checkbox"/>	<input checked="" type="checkbox"/>	<input checked="" type="checkbox"/>	<input checked="" type="checkbox"/>	<input checked="" type="checkbox"/>	<input checked="" type="checkbox"/>
Criteria:						

6.1.2 [PM Volumes SumOfMEM]

Added field VBest 30.12.1999.

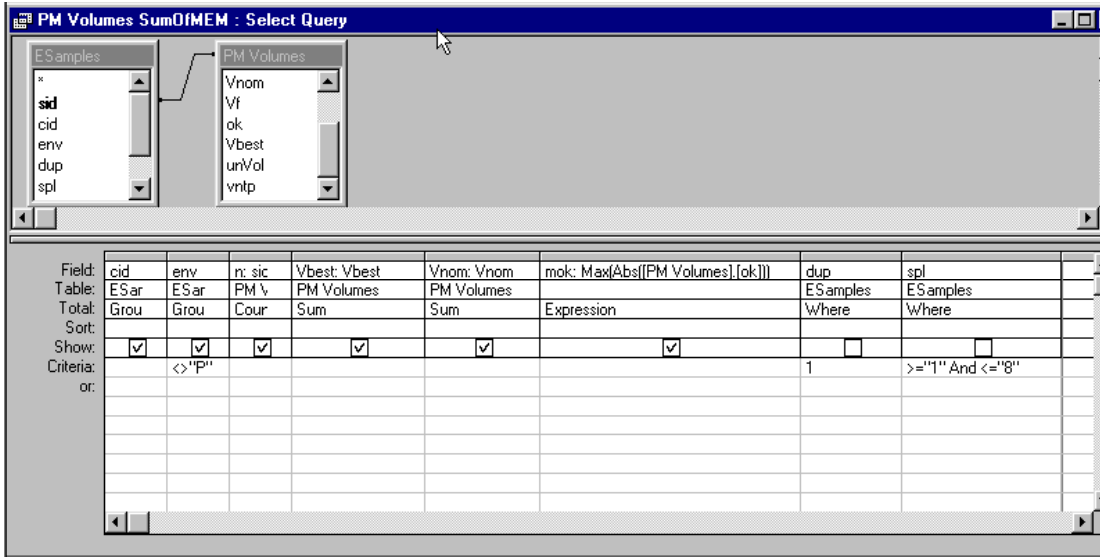

6.2 [PM c I]

This query combines the customer ID values with the home indoor concentrations calculated with [PM c].

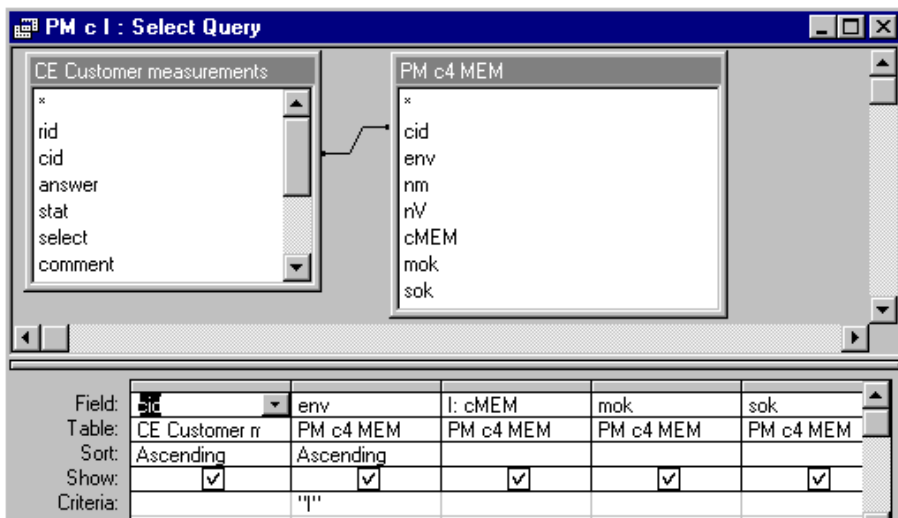

6.3 [PM c O]

This query combines the customer ID values with the home outdoor concentrations calculated with [PM c].

Field:	cid	env	O: cMEM	mok	sok
Table:	CE Customer meas.	PM c4 MEM	PM c4 MEM	PM c4 MEM	PM c4 MEM
Sort:	Ascending	Ascending			
Show:	<input checked="" type="checkbox"/>	<input checked="" type="checkbox"/>	<input checked="" type="checkbox"/>	<input checked="" type="checkbox"/>	<input checked="" type="checkbox"/>
Criteria:		"O"			

6.4 [PM c W]

This query combines the customer ID values with the workplace concentrations calculated with [PM c].

Field:	cid	env	W: cMEM	mok	sok
Table:	CE Customer measurements	PM c4 MEM	PM c4 MEM	PM c4 MEM	PM c4 MEM
Sort:	Ascending	Ascending			
Show:	<input checked="" type="checkbox"/>	<input checked="" type="checkbox"/>	<input checked="" type="checkbox"/>	<input checked="" type="checkbox"/>	<input checked="" type="checkbox"/>
Criteria:		"W"			

6.5 [PM c P1]

This query combines the customer ID values with the personal filter 1 (day filter) concentrations calculated with [PM c].

Field:	cid	sid	P1: c	ok	sok	env	dup	spl
Table:	ESamples	PM c	PM c	PM c	ESamples	ESamples	ESamples	ESamples
Sort:								
Show:	<input checked="" type="checkbox"/>	<input checked="" type="checkbox"/>	<input checked="" type="checkbox"/>	<input checked="" type="checkbox"/>	<input checked="" type="checkbox"/>	<input type="checkbox"/>	<input type="checkbox"/>	<input type="checkbox"/>
Criteria:				"1" Or "2"	Is Null Or <>3	"P"	1	"1"
or:								

6.6 [PM c P2]

This query combines the customer ID values with the personal filter 2 (night filter) concentrations calculated with [PM c].

Field:	cid	sid	P2: c	ok	sok	env	dup	spl
Table:	ESamples	PM c	PM c	PM c	ESamples	ESamples	ESamples	ESamples
Sort:								
Show:	<input checked="" type="checkbox"/>	<input checked="" type="checkbox"/>	<input checked="" type="checkbox"/>	<input checked="" type="checkbox"/>	<input checked="" type="checkbox"/>	<input type="checkbox"/>	<input type="checkbox"/>	<input type="checkbox"/>
Criteria:				"1" Or "2"	Is Null Or <>3	"P"	1	"2"
or:								

6.7 [PM c2 P48]

This query calculates the average 48 hour personal exposure by summing the m2 masses of the filters and dividing the result with sum of the sample volumes. The resulting c1 level 48 exposure is combined with the customer ID values.

Changed 30.12.1999, uses now VBest.

18.5.2000 added criterias (nm>1 and nV>1) otherwise it might be possible that there is a 48 hour value for a sample that have missing P1 or P2.

Field:	cid	nm: n	nV: n	P48: concentration[m2],[Vbest]	mok: okmaxabs[PM m2 SumOfPEMs],[mok];[PM Volumes SumOfPEMs],[mok]	sok
Table:	PM m2 S	PM m2	PM Vol			PM m2 SumOfPEMs
Sort:						
Show:	<input checked="" type="checkbox"/>	<input checked="" type="checkbox"/>	<input checked="" type="checkbox"/>	<input checked="" type="checkbox"/>	<input checked="" type="checkbox"/>	<input checked="" type="checkbox"/>
Criteria:		>1	>1		<>3	
or:						Is Null Or <>3

6.7.1 [PM m2 SumOfPEMs]

This query is used by the [PM c2 P48] query to calculate the sum of all PEM masses of each customer. These masses include buoyancy correction and field blank correction.

Field:	cid	m2	m2	m2: m2	n: sid	m2	env	dup	spl
Table:	ESamples	PM m2	PM m2	PM m2	PM m2	PM m2	ESamples	ESamples	ESamples
Total:	Group By	First	Last	Sum	Count	Where	Where	Where	Where
Sort:									
Show:	<input checked="" type="checkbox"/>	<input checked="" type="checkbox"/>	<input checked="" type="checkbox"/>	<input checked="" type="checkbox"/>	<input checked="" type="checkbox"/>	<input type="checkbox"/>	<input type="checkbox"/>	<input type="checkbox"/>	<input type="checkbox"/>
Criteria:						<>-9	"P"	1	>="1" And <"7"

6.7.2 [PM Volumes SumOfPEMs]

This query is used by the [PM c2 P48] queries to calculate the sum of all PEM volumes of each customer. Changed 30.12.1999 to use VBest.

The screenshot shows a query window with two field lists: 'ESamples' (sid, cid, env, dup, spl) and 'PM Volumes' (Vnom, Vf, ok, Vbest, unVol, vntp). Below is a query grid:

Field:	cid	n: sid	VNom: Vnom	VBest: Vbest	mok: Max(Abs([PM Volumes].[ok]))	Vbes	env	dup	spl
Table:	ESamp	PM Vol	PM Volumes	PM Volumes	Expression	PM \	ESar	ESar	ESamples
Total:	Group f	Count	Sum	Sum	Expression	Whe	Whe	Whe	Where
Sort:									
Show:	<input checked="" type="checkbox"/>	<input checked="" type="checkbox"/>	<input checked="" type="checkbox"/>	<input checked="" type="checkbox"/>	<input checked="" type="checkbox"/>	<input type="checkbox"/>	<input type="checkbox"/>	<input type="checkbox"/>	<input type="checkbox"/>
Criteria:						<>-9	"P"	1	"1" Or "2"

6.8 [PM c P1P2P48IOW]

The final endpoint of the CQN is shown below:

The screenshot shows a query window with a complex diagram involving several tables: 'CE Customer measurements', 'PM c P1', 'PM c P2', 'PM c P48', 'PM c I', 'PM c O', and 'PM c W'. Below is a query grid:

Field:	cid	P1	P2	P48	I	O	W
Table:	CE Customer measurements	PM c P1	PM c P2	PM c2 P48	PM c I	PM c O	PM c W
Sort:							
Show:	<input checked="" type="checkbox"/>	<input checked="" type="checkbox"/>	<input checked="" type="checkbox"/>	<input checked="" type="checkbox"/>	<input checked="" type="checkbox"/>	<input checked="" type="checkbox"/>	<input checked="" type="checkbox"/>
Criteria:							

7. Data checking and cleaning

Few new forms have been created to view

- all filter sample related tables affecting the concentration calculation
- all different filter mass queries, including weighing room condition table

7.1 [PM Summary Tables]

This form shows all fields from [PM filter sample] mass table and different tables affecting filter concentration calculation (excluding weighing room conditions). The record set is updatable (values can be edited and corrected using this form).

PM Summary Tables : Form
_ _ X

ESamples.cid:

env:

dup:

spt:

sok:

sid	run	Start	End	Vmem	rok	comment
400752	1	13.01.97 08:20	13.01.97 17:30		1	
400752	2	14.01.97 07:45	14.01.97 17:00		1	
400752	3	15.01.97 06:10	15.01.97 07:25		1	
*	1					

Record: of 3

PM Filter samples

sid:

Sdate:

ms:

ids:

Edate:

me:

ide:

mok:

EFlows

cid:

env:

dup:

pf:

af:

Vpf:

Vaf:

Vpem:

Fok:

Vok:

Ok:

ekok:

EEquipment

cid:

env:

dup:

pump:

set:

lath:

cyim:

charge:

EPositioning

cid:

rooms:

lroom:

lpos:

lfloor:

Opos:

Obalcony:

Wpos:

Prroom:

ESetupDates

cid:

Sdate:

Edate:

ECondSetup

Sdate:

ID:

rh:

rhm:

T:

Tm:

P:

Pm:

scok:

cyclone (2) inlet broken

Opos: pump did not start, no O-MEM measurement

Record: of 1106

7.2 [PM Summary Masses]

This form shows all fields from [PM filter sample] mass table and different mass calculation queries. The record set is not updatable (values cannot be edited in this form).

PM Summary Masses : Form

ESamples.cid: 

env: 

dup:

spl:

sok:

 Set Landscape before printing!

PM m4
cid: env: dup: spl:

WRConditions
date: rh: T: P: a: f:

PM Filter samples	PM m0	PM m1	PM m2	PM m4	WRConditions
sid: <input type="text" value="895851"/>	sid: <input type="text" value="895851"/>	sid: <input type="text" value="895851"/>	sid: <input type="text" value="895851"/>	sid: <input type="text" value="895851"/>	date: <input type="text" value="21.02.97"/>
Sdate: <input type="text" value="3.02.97 08:59"/>	Dates: <input type="text" value="13.02.97"/>	Sdate: <input type="text" value="13.02.97"/>			rh: <input type="text" value="19.4"/>
ms: <input type="text" value="128.891"/>	ms0: <input type="text" value="128.891"/>		m1: <input type="text" value="0.210"/>		T: <input type="text" value="20.7"/>
ids: <input type="text" value="vt"/>	Date: <input type="text" value="21.02.97"/>	Edate: <input type="text" value="21.02.97"/>	blank: <input type="text" value="0.0062"/>	m2: <input type="text" value="0.204"/> m4: <input type="text" value="0.204"/>	P: <input type="text" value="747.3"/>
Edate: <input type="text" value="1.02.97 12:01"/>	me0: <input type="text" value="129.1"/>	m1: <input type="text" value="0.210"/>			a: <input type="text" value="1.179"/>
me: <input type="text" value="129.1"/>		mb: <input type="text" value="0.209"/>			f: <input type="text" value="1.001"/>
ide: <input type="text" value="kk"/>					

mok: mok: mok: mok: mok:



Record: of 1325

7.3 [PM Summary Concentrations]

This form shows all fields from [PM filter sample] mass table and different concentration calculation queries. The record set is not updatable (values cannot be edited in this form).

PM Summary Concentrations : Form
[] [] [X]

ESamples.cid: <input type="text" value="1870"/> env: <input type="text" value="P"/> dup: <input type="text" value="1"/> spl: <input type="text" value="2"/> sok: <input type="text"/>	<div style="border: 1px solid gray; width: 100px; height: 100px; margin-bottom: 5px;"></div> <input type="checkbox"/> Set Landscape before printing!	<table border="1" style="width: 100%; border-collapse: collapse; text-align: center;"> <thead> <tr> <th>sid</th> <th>run</th> <th>Start</th> <th>End</th> <th>Vmem</th> <th>rok</th> <th>comment</th> </tr> </thead> <tbody> <tr> <td>400752</td> <td>1</td> <td>13.01.97 08:20</td> <td>13.01.97 17:30</td> <td></td> <td>1</td> <td></td> </tr> <tr> <td>400752</td> <td>2</td> <td>14.01.97 07:45</td> <td>14.01.97 17:00</td> <td></td> <td>1</td> <td></td> </tr> <tr> <td>400752</td> <td>3</td> <td>15.01.97 06:10</td> <td>15.01.97 07:25</td> <td></td> <td>1</td> <td></td> </tr> <tr> <td>*</td> <td>1</td> <td></td> <td></td> <td></td> <td></td> <td></td> </tr> </tbody> </table> Record: <input type="text" value="1"/> of 3	sid	run	Start	End	Vmem	rok	comment	400752	1	13.01.97 08:20	13.01.97 17:30		1		400752	2	14.01.97 07:45	14.01.97 17:00		1		400752	3	15.01.97 06:10	15.01.97 07:25		1		*	1					
sid	run	Start	End	Vmem	rok	comment																															
400752	1	13.01.97 08:20	13.01.97 17:30		1																																
400752	2	14.01.97 07:45	14.01.97 17:00		1																																
400752	3	15.01.97 06:10	15.01.97 07:25		1																																
*	1																																				

PM Filter samples	EFlows	PM Flows	PM Volumes	PM c1	PM c2	PM c
sid: <input type="text" value="400752"/>	cid: <input type="text" value="1870"/>	sid: <input type="text" value="400752"/>	sid: <input type="text" value="400752"/>	sid: <input type="text" value="400752"/>	sid: <input type="text" value="400752"/>	sid: <input type="text" value="400752"/>
Sdate: <input type="text" value="3.01.97 13:12"/>	env: <input type="text" value="P"/>	spl: <input type="text" value="2"/>	dur: <input type="text" value="19.67"/>			
ms: <input type="text" value="105.676"/>	dup: <input type="text" value="1"/>					
ids: <input type="text" value="kk"/>	pf: <input type="text" value="#Name?"/>	pf: <input type="text" value="4.004"/>				
Edate: <input type="text" value="7.01.97 09:37"/>	af: <input type="text" value="#Name?"/>	af: <input type="text" value="3.925"/>				
me: <input type="text" value="105.764"/>	Vpf: <input type="text" value="0.814"/>	fn: <input type="text" value="3.981"/>	Vf: <input type="text" value="4.698"/>			
ide: <input type="text" value="ak"/>	Vaf: <input type="text" value="0.818"/>	nomf: <input type="text" value="4.00"/>	Vnom: <input type="text" value="4.720"/>			
	Vpem: <input type="text" value="11.267"/>					
	Fok: <input type="text"/>	Vok: <input type="text"/>		c1nom: <input type="text" value="18.874"/>	c2nom: <input type="text" value="18.472"/>	c: <input type="text" value="18.47"/>
mok: <input type="text" value="1"/>	Ok: <input type="text" value="2"/>	Ok: <input type="text" value="1"/>	ok: <input type="text" value="2"/>	ok: <input type="text" value="2"/>	ok: <input type="text" value="2"/>	ok: <input type="text" value="2"/>
	cyclone (2) inlet broken		Ts: <input type="text" value="20.1"/>			
			Ps: <input type="text" value="773"/>			
			Te: <input type="text" value="20.6"/>			
			Pe: <input type="text" value="755"/>			

Record: of 1187

8. Warning about Old Queries

During the EADB development stage a number of draft queries have been developed. These include the old query [PM Concentrations] and queries based on it. The concentration calculation in these is based on the direct readings of the balance, as well as unnormalized flows/volumes, and thus the accuracy of such results is not optimal.

The user of a query should ensure that the calculations done in the query are performed using correct algorithms. Only queries that have been documented in this manual or elsewhere can be used without reverse engineering the working of the query or the query network.

There might be reasonable or justified uses for these queries and new local queries based on them. Local queries based on old EADB queries will lose their functionality when these old queries are removed. Be warned that the results of all the queries in the system have not been tested and verified to be reliable.

8.1 Queries deleted from the 11.6.1998 version

Query	Description/Why deleted
[PM m] [PM Masses]	Calculated aerosol mass from raw/uncorrected weighing results --
[PM Concentrations] [PM Concentration statistics]	Calculated concentrations from uncorrected masses and volumes --
[PM Mass statistics] [PM Mass and Concentration statistics]	Produced statistics using uncorrected weighing results --

8.2 Queries deleted from the 23.6.1999 version

Query	Description/Why deleted
[PM c1 P48] [PM c IOW] [PM c IP2] [PM c WP1] [PM c1 cid IOW P48]	c1 level concentration only this functionality is part of the [PM c P1P2P48IOW] query -- -- -- --

8.3 Queries changed in 000601 version

Query	Description / Why
[PM c4 MEM]	uses VBest
[PM Volumes]	added VBest
[PM Volumes SumOfMEM]	uses VBest
[PM Volumes SumOfPEMs]	uses VBest
[PM c2 P48]	uses VBest
[PM c]	uses cbest

Changes made should not affect any other existing queries, I hope. Old queries are still in Helsinki EADBTOOL, same name + (bkup 991230).

1.6.2000 Esa Kaarakainen

EXPOLIS LOCAL CO DATABASE

User's Manual

User's Instructions for Updating to version 9811

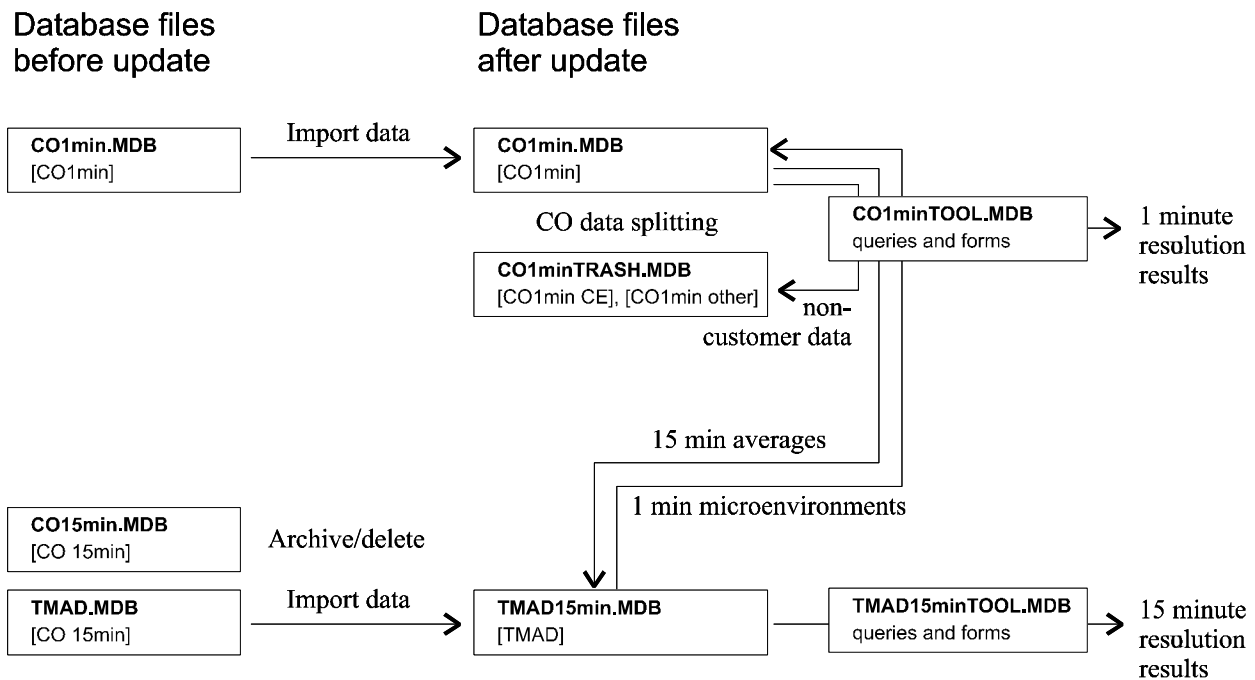

EXPOLIS

Otto Hänninen

Esa Kaarakainen

KTL Environmental Health
P.O.Box 95
FI-70701 KUOPIO
FINLAND

Email OTTO.HANNINEN@KTL.FI
Tel +358-17-201 171
GSM +358-400-673 207
Fax +358-17-201 265

KAARAKAI@HYTTI.UKU.FI
+358-17-201 347
+358-17-201 265

Contents of this document

CONTENTS OF THIS DOCUMENT	2
E-MAIL FOREWORD	3
UPDATE 9811 CONTENTS	4
SUMMARY OF CHANGES TO PREVIOUS VERSIONS	5
INSTALLING THE UPDATE FILES	6
0. DOWNLOAD OR EXTRACT THE MAIL ATTACHMENT FILES	6
1. RENAME YOUR PREVIOUS VERSION(S) OF THESE FILES IN THE \DATA DIRECTORY	6
2. COPY THE DOWNLOADED FILES TO YOUR EXPOLIS DATA DIRECTORY	6
3. OPEN ACCESS AND LOG ON AS LADMIN	6
4. OPEN THE NEW ... \DATA\CO1MINTOOL.MDB FILE	7
5. RE-LINK THE NEW TOOL DATABASE TO THE LOCAL DATA DATABASE TABLES	7
6. IMPORT OLD DATA BY RUNNING QUERY [IMPORT OLD DATA]	8
7. REPEAT THE STEPS 5 - 6, NOW FOR THE TMAD15MINTOOL.MDB FILE	9
8. CLOSE ACCESS	9
CHECKING YOUR DATA: DATA CLEANING	10
DRAFT DATA CLEANING (DC I)	10
DATABEAR CLOCK DATA CLEANING (DC II)	10
DETAILED DATA CLEANING (DC II)	10
SPLITTING THE CO DATA	11
SENDING CO DATA TO KTL	12
APPENDIXES	13
APPENDIX 1: ACCESS LINKED TABLE MANAGER ADD-ON INSTALLATION	
APPENDIX 2: LANGAN.EXE INSTRUCTION SHEET	
APPENDIX 3: 57TO58.EXE INSTRUCTION SHEET	
APPENDIX 4: EIB_COMB.EXE INSTRUCTION SHEET	
APPENDIX 5: CO DOWNLOAD COMBINE.EXE INSTRUCTION SHEET (IMPORTING CO DATA FROM .TXT FILES TO THE .MDB DATABASE)	
APPENDIX 6: LIST OF EXPOLIS DATA MANAGEMENT DOCUMENTS	

E-MAIL FOREWORD

Delivery of Expolis CO and TMAD database update version 9811

Dear Data Workgroup members

You are about to receive an major update to the Expolis CO database system. The related files are listed on next page, and the changes in functionality are listed on the next page after that.

You need to import your CO and TMAD data from the previous data database files to the updated ones. Then you need to apply the data cleaning tools in the update to check the consistency of your data.

After your data has been imported and checked, you can send it to KTL.

We will send these files via e-mail and put the files on our WWW page for downloading.

I send **this e-mail message to all team members**. **The files** will be sent only to data management work group members, if you do not inform me otherwise. Data management workgroup members are Evi Samoli, Lucy Oglesby, Celine Boudet, Paolo Carrer, Radim Sram.

Best regards

Otto Hänninen

Update 9811 contents

The Expolis CO database update 9811 consists of the following data/query/documentation/supplementary files.

Database Files	Explanation
CO1min.MDB	CO data database
CO1minTOOL.MDB	CO query database for data cleaning, calibration and 15 minute average calculation
CO1minTRASH.MDB	CO archive database for non-customer measurement data (data from download file for time when the PEM case was not with the customer and test and other measurements)
TMAD15min.MDB	TMAD data database
TMAD15minTOOL.MDB	TMAD and CO queries using 15 minute data
COUP9811.ZIP	Above files are packed together in this .zip file

Supplementary Files	Explanation
57to58.EXE	Program for correcting time field errors in EIBEARM.EXE downloaded files.
EIB_COMB.EXE	Filter program to combine EIBEARM.EXE downloads (3 or 4 files per customer in binary format) to the .TXT format
CO Download combine.EXE	Filter to combine all customer CO downloads (.TXT files) for importing to CO 1 min.MDB database

SUPP9811.ZIP Above files are packed together in this .zip file

Instructions, documentations: on www-page as files, on paper in letter

Update 9811 installation.DOC	This document in Word 7 format NOTE: all separate CO related instructions sheets are included in the Appendixes of this document.
CO User's Manual.DOC	CO database documentation in Word 7 format
DOC9811.ZIP	Above files are packed together in this .zip file
PKUNZIP.EXE	Unpacking program to unzip .ZIP files (no support for long filenames in this unzipping program; long filenames are converted to the "nnnnnn~1.EXT" style names)

Summary of changes to previous versions

The EADB updated 9811 include following changes compared to the previous versions of affected databases. The TMAD database previous version is 9803 and CO database previous version is 9806. The database file level changes are shown in the cover of this document too.

- Changes in database file structure
 - file TMAD.MDB has been renamed as TMAD15min.MDB
 - queries in previous TMAD.MDB have been moved to TMAD15min.TOOLMDB

 - contents of file CO15min.MDB has been moved to TMAD15min.MDB
 - and the file CO15min.MDB has been removed
 - queries in previous CO1min.MDB have been moved to CO1minTOOL.MDB
 - a new data file CO1min trash.MDB has been added for non-customer data

 - CO1min.MDB and CO1minTOOL.MDB
 - a new field for 1 minute resolution microenvironment coding has been added
 - Data cleaning queries and forms have been created. Especially
 - time calibration form to compare sample run timing to CO timing
 - time calibration form to compare TMAD and CO timing
 - temperature correction and [ppm] to [mg/m⁻³] conversions added to the Concentration Query Network: now all concentration output is in [mg/m⁻³]
 - time correction procedure has been added to correct the CO timing when the Databear clock has been wrong
 - several static tables have been added to speed up the database and to facilitate data cleaning
 - data splitting for customer data and non-customer (trash=archive) data has been added, as well as a tool to manage the main CO data and archived sections of CO data. This tool is called **CO Archive Manager**, or **CAM**.

 - TMAD15min.MDB and TMAD15minTOOL.MDB
 - a new table for Databear CO and temperature measurement 15 min statistics
 - a new table for PEM case filter sample run averages for PEM volume normalisation. Normalisation query will be defined in the EADBTOOL.MDB.
-

Installing the update files

0. Download or Extract the mail attachment files

- CO1min.MDB, CO1min trash.MDB, CO1minTOOL.MDB
- TMAD15min.MDB, TMAD15minTOOL.MDB

1. Rename your previous version(s) of these files in the \DATA directory

Old file	New name for the old file
CO1min.MDB	CO1min9806.MDB
CO15min.MDB	CO15min9806.MDB (this file will not be used any more)
TMAD.MDB	TMAD9803.MDB

Keep the files still in the \DATA directory. After you have updated the data from these files to the new version 9811 files you can move these old files to your archive or backup location.

2. Copy the downloaded files to your Expolis DATA directory

After this step your \DATA directory should contain files:

Old files	CO1min9806.MDB CO15min9806.MDB TMAD9803.MDB
New 9811 files	CO1min.MDB CO1min trash.MDB CO1minTOOL.MDB TMAD15min.MDB TMAD15minTOOL.MDB

3. Open Access and log on as LADMIN

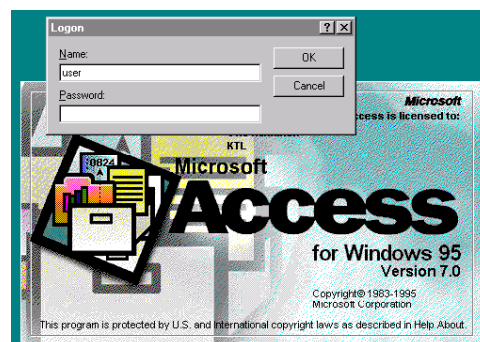

4. Open the new ...\\DATA\\CO1minTOOL.MDB file

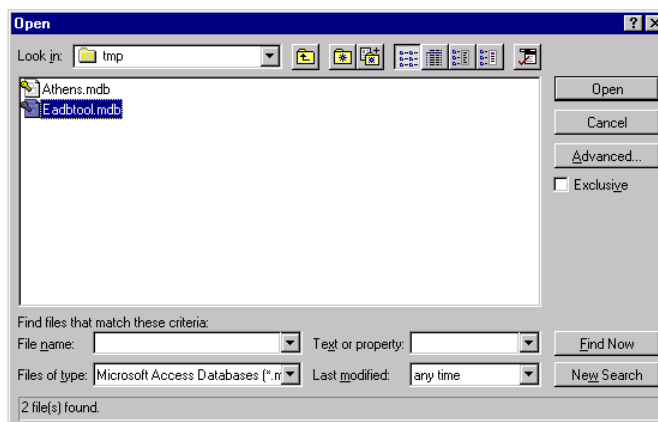

5. Re-link the new tool database to the local data database tables

- local EADB data file, e.g. ATHENS.MDB
- CO1min.MDB
- CO1min trash.MDB
- CO1min9806.MDB (link for importing old data)
- TMAD15min.MDB
- TMAD9803.MDB (link for importing old data)

In the database window you can select View – Details from the menu to see descriptive texts for each table. These texts show to which database the linked table should be linked to.

For the CO1minTOOL.MDB the table links are listed below (the data database is shown in the table description):

Name	Description	Modified	Created	Type
A1 Equipment	-> HELSINKI.MDB	23.11.1998 ...	6.11.1998 1...	Table: Link
CO15min	-> TMAD15min.MDB (Static)	27.11.1998 ...	19.11.1998 ...	Table: Link
CO calibration gas bottles	-> HELSINKI.MDB	23.11.1998 ...	3.6.1998 10...	Table: Link
CO calibrations	-> HELSINKI.MDB	27.11.1998 ...	3.6.1998 10...	Table: Link
CO cid start end	-> CO1MIN.MDB (static)	27.11.1998 ...	19.11.1998 ...	Table: Link
CO Temp Avg	-> CO1MIN.MDB (static)	27.11.1998 ...	19.11.1998 ...	Table: Link
CO Time cor	-> CO1MIN.MDB	27.11.1998 ...	27.11.1998 ...	Table: Link
CO1min	-> CO1MIN.MDB (Main data)	27.11.1998 ...	19.11.1998 ...	Table: Link
CO1minOld	-> CO1min9806.mdb (Old data)	27.11.1998 ...	24.11.1998 ...	Table: Link
CO1minTrash CE	-> CO1minTRASH.MDB (Customer non-SR data)	27.11.1998 ...	19.11.1998 ...	Table: Link
CO1minTrash Other	-> CO1minTRASH.MDB (Non-customer data)	27.11.1998 ...	19.11.1998 ...	Table: Link
DBMt CO cids all	-> CO1MIN.MDB	23.11.1998 ...	19.11.1998 ...	Table: Link
DBMt Static Queries	-> CO1MIN.MDB (StaUp)	27.11.1998 ...	19.11.1998 ...	Table: Link
DBMt Static Tables	-> CO1MIN.MDB (StaUp)	27.11.1998 ...	19.11.1998 ...	Table: Link
DC CO Peaks	-> CO1MIN.MDB (Static)	27.11.1998 ...	23.11.1998 ...	Table: Link
EContact	-> HELSINKI.MDB	25.11.1998 ...	4.6.1998 13...	Table: Link
EEquipment	-> HELSINKI.MDB	23.11.1998 ...	3.6.1998 10...	Table: Link
ERuns	-> HELSINKI.MDB	23.11.1998 ...	4.6.1998 13...	Table: Link
ESamples	-> HELSINKI.MDB	23.11.1998 ...	4.6.1998 13...	Table: Link
P Stat	-> HELSINKI.MDB	23.11.1998 ...	4.6.1998 13...	Table: Link
PEM Sampling ranges	-> CO1MIN.MDB (Static)	27.11.1998 ...	19.11.1998 ...	Table: Link
TMAD	-> TMAD15MIN.MDB	23.11.1998 ...	19.11.1998 ...	Table: Link
TMAD CID t Errv	-> TMAD15MIN.MDB (Static/TMAD clock check)	27.11.1998 ...	19.11.1998 ...	Table: Link
TMAD Cust out	-> TMAD15MIN.MDB (Static/TMAD clock check)	27.11.1998 ...	19.11.1998 ...	Table: Link

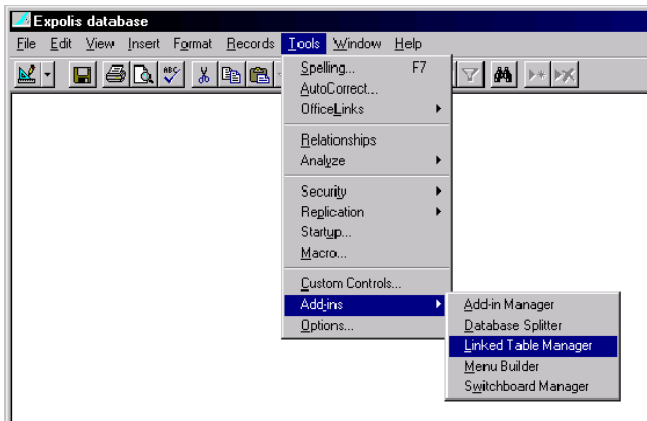

5b select all tables, insist on prompting new location of data. Press ok

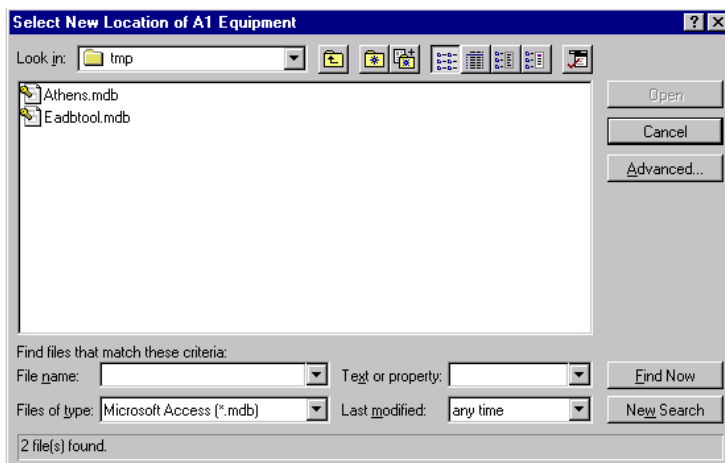
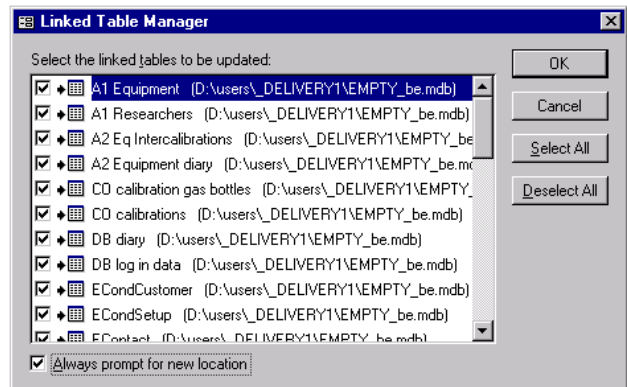

5c For each table select the corresponding local data database file from the \DATA directory

6. Import old data by running query [Import old data]

This query links to the old data database file and the new (updated) data file and copies data from the old table to the new table. Query with this same name exists in both the tool databases. To make sure that your table links have been properly updated in above step 5, open the tables before running this query. The new table should be empty and the old table should have all your data.

Database

CO1minTOOL

TMAD15minTOOL

Open linked tables:

[CO1min], [CO1minOld]

[TMAD], [TMADOld]

After running the [Import old data] query, also the new table should contain a copy of the data.

7. Repeat the steps 5 - 6, now for the TMAD15minTOOL.MDB file

Close CO1minTOOL.MDB and open the TMAD15minTOOL.MDB database. Then go back to step 5. For the TMAD15minTOOL.MDB the table links are listed below:

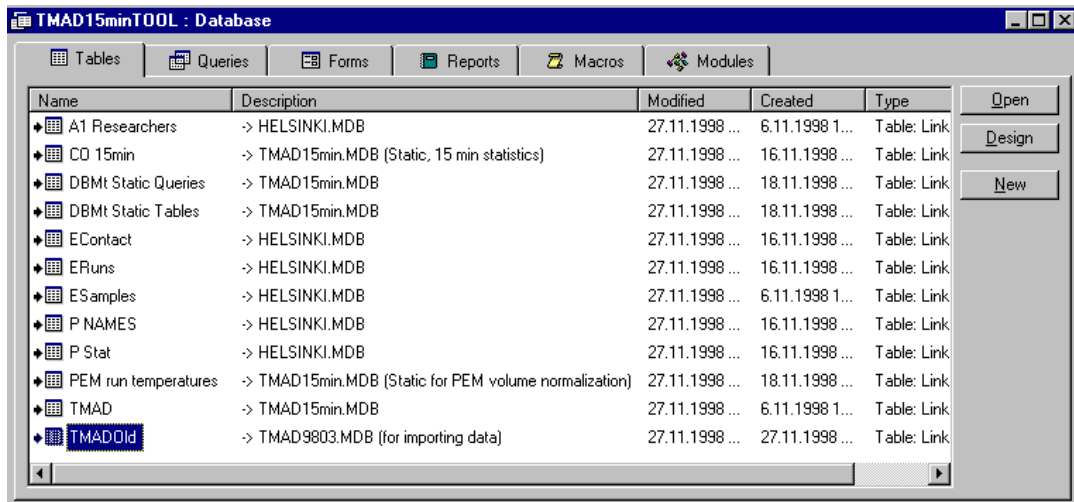

8. Close Access

Next steps include

- import data to your databases
- clean/check the data
- report data cleaning results
- prepare to send your data database files to KTL

Checking your data: Data cleaning

This update comes with tools for data cleaning. Before sending the database to KTL for to be combined to the international Expolis database, you must ensure that your data has been imported properly and is consistent with the measurements.

Data cleaning has been dedicated a separate section in the Expolis CO Database User's Manual. Data cleaning depends on some static tables, which must be updated before proceeding. All these details are discussed in the User's Manual. The most important steps in data cleaning are:

Draft data cleaning (DC I)

- 1 Ensure that the data for all you measurement customers has been imported
- 2 Ensure that you have Databear calibration coefficients in the *ATHENS.MDB* tables
- 3 Ensure that you have had no errors leading to lost channel data

This step might lead you to find some lost download files or channel files. If this is the case, import these data into the database and go back to the beginning of DC I.

Databear clock data cleaning (DC II)

- 4 Check that the Databear clock has been consistent with other Expolis measurements (runs)

Time correctness is crucial when splitting the CO database before next DC step. If the Databear clock is not correct, some real customer data will be replaced with nonsense data, and the timing of microenvironmental concentrations will be false. The timing check includes lengthy manual browsing of the data, but it must be stressed that this is very IMPORTANT!

Detailed data cleaning (DC II)

After removing the non-customer data to the CO1min trash.MDB check that there are no other minor errors in the data

- 5 Check for peaks
- 6 re-check for missing channels
- 7 list floor hits (occasions when Databear has shown 0.0 CO concentration)
- 8 check for locked values (when Databear has shown constant value for a longer time period)

Now all data cleaning steps have been done. If any errors were found, you should either correct them or remove false data. Then rerun the data cleaning from beginning to make sure that your database is clean.

Splitting the CO data

A new data file is included in the 9811 update for storing the CO data which is not part of the Expolis customer measurements. This file is called CO1minTRASH.MDB, and it contains two data tables, to which non-customer data is moved.

Data tables in the CO1minTRASH.MDB are

Table	Contents
CO1min CE	Data from customer files before and after the case was not with the customer
CO1min other	All other data: test measurements, microenvironmental measurements etc.

Dividing the data from the CO1min.MDB into these two other archive type of tables is called splitting the CO data. Because splitting the customer data into period when the case was in customer measurement and to the periods before and after that is based on the date and time field in the download file, the timing of the Databear clock must be checked before running the splitting queries. (see data cleaning step 4: timing)

A separate tool called **CO Archive Manager** or **CAM** was written to help to move CO data sections between the CO1min data table and the two archive tables. For example in cases when an timing error in the Databear unit is found after the splitting, the whole customer or other measurement should be moved to the CO1min data table for running the time correction query, and then the split should be run again for this customer.

Splitting the CO data is described in more detail in Expolis CO Local Database's User's Manual. Also CAM is described there.

Sending CO data to KTL

After you have carefully checked the CO database and corrected all found errors and mistakes, and removed all suspicious data that cannot be confirmed or corrected, the data files can be sent to KTL.

The Access databases should be repaired and compressed with Access built in tools before sending. These tools are available in Access Tool menu when no database file is open. To repair and compress a database file, follow these steps

- 0 Make a backup of the database file
- 1 Open Access with no database files open in it.
- 2 From Tools –menu select Repair
- 3 Select the file to be repaired. Press Ok to start
- 4 Wait until the repair has finished

- 5 From Tools –menu select Compress
- 6 Select the file to be repaired. Press Ok.
- 7 Give name for the compressed database. You can use the same name, but be carefull not to overwrite any other valid database file. Press ok.
- 8 Wait until the compress has finished

Now the structure of the database file has been checked and all unnecessary space has been removed from the database file. The Access databases are very tightly packed, so no noticeable amount of extra space can be saved with PKZIP or other compression utilities.

CO data files to be sent to KTL are

CO1min.MDB

TMAD15min.MDB (containing also TMAD data besides 15 min CO statistics)

These files can be sent to KTL using e.g.

- e-mail
 - writable 650 MB CD-ROM diskettes
 - 100 MB Zip diskettes (Manufacturer IOMEGA)
 - 1 GB Jazz diskettes (Manufacturer IOMEGA)
-

Appendixes

Appendix 1: Access Linked Table Manager Add-on Installation

Expolis databases are Microsoft Access 95 (version 7.0) databases. Linked tables in the databases are managed using Access Add-on product, **Linked table manager**, which comes with the Office/Access 95 CD-ROM, but is not part of the default installation. Thus this feature must be manually installed according to these instruction.

Appendix 2: LANGAN.EXE Instruction sheet

A special Expolis download program **LANGAN.EXE** was created for downloading CO data from the Databear continuous portable CO monitor. This program features combined download of all channels to a single .TXT file and checking of Expolis specific hardware settings in the monitor. This instruction sheet describes the use of this download program.

Appendix 3: 57to58.EXE Instruction sheet

The manufacturer provided general purpose download program, **EIBEARM.EXE**, creates a separate ASCII file for each downloaded channel. Due to a undocumented feature in this download program, the date/time field of the separate channel files contain different value in the second field. These must be corrected before combining the separate channel files to one common customer .TXT file.

Appendix 4: EIB_COMB.EXE Instruction sheet

The manufacturer provided general purpose download program, **EIBEARM.EXE**, creates a separate ASCII file for each downloaded channel. The separate channel files are combined to one common customer .TXT file with **EIB_COMB.EXE**.

Appendix 5: CO Download combine.EXE Instruction sheet (Importing CO data from .TXT files to the .MDB database)

Before importing the CO download .TXT files to Access, the customer id number must be added to the beginning of each data line. This is done with **CO Download combine.EXE**. This program also copies all .TXT files together for faster import to Access.

Appendix 6: List of Expolis Data Management Documents

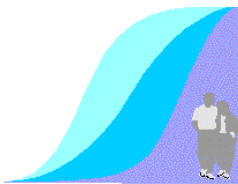

EXPOLIS

Exposure
Distributions
of Adult Urban
Populations

KTL ENVIRONMENTAL HEALTH

Otto Hänninen

P.O.Box 95
FI-70701 KUOPIO
FINLAND

International tel. +358-17-201 171
International fax +358-17-201 265
E-mail/internet OTTO.HANNINEN@KTL.FI

INSTRUCTION SHEET

ACCESS LINKED TABLE MANAGER

Data Management

1 Page

30. November 1998

Subj. INSTALLING THE ACCESS ADD-ON: Linked table manager
Ref.

Most of the tables in the TOOL databases are linked to tables in data databases. To manage these links, you need to have an optional feature of the Access 95 to be installed. This sheet describes how to install the feature. You need to have the Access 95 CD-ROM at hand.

1. Start Office 95 installation (setup.exe) from the CD-ROM or from the network

- note that the Expolis database **MUST** be used only with Access version 7 (Office 95 version).
- Access 8 (Office 97) can convert the existing file to it's new format, but then the file cannot be converted back.

2. Select Microsoft Access and Press Change Option... button

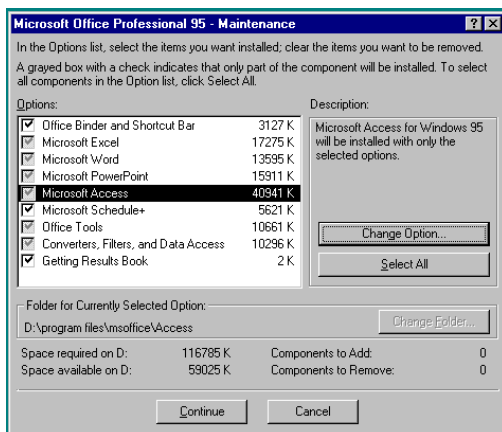

3. Select Developer tools and press Ok buttons until installation is complete

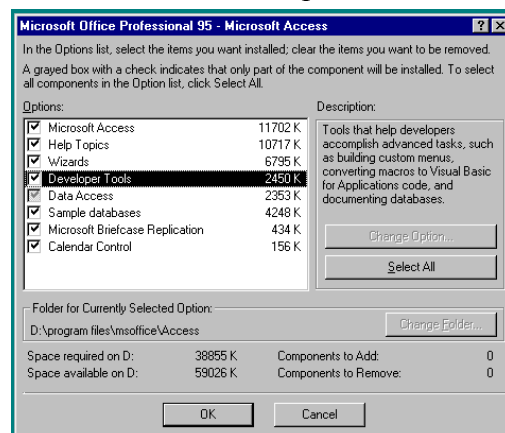

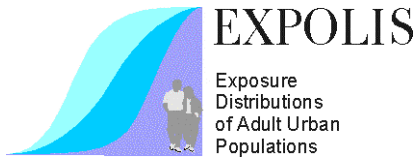

KTL ENVIRONMENTAL HEALTH

Otto Hänninen

Mannerheimintie 166
FI-00300 HELSINKI
FINLAND

International tel. +358-9-5885 182
International fax +358-9-4744 786
E-mail/internet OTTO.HANNINEN@KTL.FI

LANGAN.EXE INSTRUCTIONS

1 Page

16. January 1997

OH

Subj. How to use the Expolis communications program for the Databear

Ref.

LANGAN.EXE is an Expolis specific simple to use tool to check and program Databear CO monitor and to download the measurement results.

The main features (compared to EIBEARM.EXE) are:

- a Windows program, running under all Windows versions
- makes the SOP specified Expolis specific checks automatically
- finds the Databear from any COM port automatically
- data download from all channels goes to one file, which can be named by the customer id

LANGAN.EXE is very easy to use. The output of EIBEARM.EXE, having all channels in different files, must be later separately combined to one file/customer. Thus it is advisable to use LANGAN.EXE in all Expolis measurements.

The Databear settings cannot be changed to non-Expolis values with LANGAN.EXE. Thus in these cases EIBEARM.EXE must be used.

Short instructions follow. See the CO SOP and Databear manual for more details.

1 Start LANGAN.EXE program file

if using the larger external temperature range (Helsinki), use command line parameter /e
eg. LANGAN.EXE /E

in Windows 95 or Windows NT4 create a shortcut to the program file with the proper command line definition, as well as proper working directory. Output files go to the working directory, so it should be the data archive for the CO-files.

2 LANGAN.EXE searches for Databear

Databear must be connected with the cable to one of the serial ports of the PC (COM port).

LANGAN.EXE searches all ports visible to Windows that are not used currently by another program (searched ports appear on the screen as numbers in parentheses).

3 Checking Databear settings

When Databear connection is found, LANGAN.EXE reads all the Databear settings relevant in Expolis measurements. These settings are printed on the screen, and values that are not correct (for Expolis), are marked with '*'. A dot in place of the '*' means that the value is ok.

- * Value is not correct for Expolis measurements
- Value is ok

4 Suggested corrections

After printing the settings, LANGAN.EXE prints out suggested corrections to the settings. If this output section is empty, then all seems to be ok.

Part of the corrections, like changing batteries, must be done manually.

Part of the corrections can be done by changing the programmed Databear settings.

5 Changing Databear programmed settings

If there were suggested corrections(previous step), LANGAN.EXE asks Yes/No questions to change Databear programmed settings.

Group one: values that do not clear Databear memory, but change the downloaded values

These changes can be done (with consideration) even after measurement (before download).

- reprogram the Databear clock according to the PC (affects only the last set)
- change channel specific settings like offset and slope (affects all sets for this channel)

Group two: values that clear Databear memory

These changes must be done before next measurement (after download).

- change the Databear channels in use (channel map)
- change the Databear sampling period

The default is always No (no action, no change), so pressing ENTER guides you through the questions.

Selecting Y+ENTER programs the change to the Databear memory.

6 Downloading data

If no changes were made to the Databear settings (as after the measurement), LANGAN.EXE asks for the customer id as the filename.

- Give no name to skip the data download.
- Give the filename (customer id) to download.

7 Resetting Databear memory

After the download is complete, LANGAN.EXE shows a summary of the data for all channels. If all values seem to be correct, you can reset the Databear memory.

8. Next Databear

In the end of this procedure, LANGAN.EXE waits for ENTER to go to beginning, or you can quit the program.

Example output of the LANGAN.EXE program

```
LANGAN.EXE          PC Clock is 15.01.97 15:20:17
                   © Otto Hänninen  11/1996
```

```
Databear Mesurer Communication program for Expolis
```

```
-----
CTRL-C or File-Exit quit, ARROW KEYS scroll the window up & down.
-----
```

```
Using External temperature sensor range -40..88°C
-----
```

```
Searching for Databear... (1) Databear connected to port COM1
```

```
Checks: * indicates value with error
```

```
-----
Serial nr 1605      PC clock    15.01.97 15:20:23
User ref  NewBear   Last sample 15.01.97 15:19:03 .
-----
```

```
Channels          [ ] [1] [2] [3] [4] .
Sampling           60   s   .
Ext. batt          5.4   V   .
Int. batt           4.8   V   .
-----
```

```
-----
Set  Samples  Duration  First Sample      Last Sample
  1      7680  05  8:00   10.01.97 07:19:03  15.01.97 15:19:03
  2         0  00  0:00
  3         0  00  0:00
  4         0  00  0:00
-----
```

```
-----
Ch  Offset    Slope  Value  Sensor      Header
  1  0.000    0.500   1.0   CO        ppm   CiTiceL # 178167
  2 -17.778    0.278  22.3  cTemp     °C    Cell Temperature
  3  0.000    0.050   0.9   CO*10    ppm   High Resolution CiTiceL
  4 -40.000    0.500  87.5* extTemp °C    External Temperature
-----
```

```
Suggested corrections:
```

```
Check why channels 2 and 4 show different temperature.
```

```
Enter Customer id to download data (or ENTER to skip): CUST_ID
```

```
Downloading ch4: 7686 B Done.
```

```
Writing to CUST_ID.TXT...
```

```
Channel  Count Average Minimum Maximum
CO128   1   7680    1.4    0.0   113.5
CO12.8  3   7680    1.2    0.0    12.8
Temp i  2   7680   17.4   -4.4   23.9
Temp e  4   7680   87.3  -27.5   87.5
```

```
Reset Databear memory?      ALL DATA WILL BE CLEARED  [N|y]
```

```
Press CTRL-C or ALT-F4 to quit, ENTER to repeat
```

**EXPOLIS**Exposure
Distributions
of Adult Urban
Populations**KTL ENVIRONMENTAL HEALTH**Mannerheimintie 166
FI-00300 HELSINKI
FINLAND

Otto Hänninen

Esa Kaarakainen

International tel. +358-9-5885 182

International fax +358-9-4744 786

E-mail/internet OTTO.HANNINEN@KTL.FI

EXPOLIS**58TO57.EXE INSTRUCTIONS**

Data Management

2 Pages

58TO57.EXE.doc

17. July 1998 / eKa

Subj. How to use the 58TO57 to correct measurement times in EIBEARM download files
Ref.

58TO57 is a Windows program to correct measurement times in the CO data files downloaded with EIBEARM.EXE. With 58TO57 you can change seconds of measurement time on download files.

The main feature is:

- change the measurement seconds into desired value

There might be some errors in download times between different channels on the EIBEARM download files. If seconds are different on other channels than channel 1, EIBCOM does not read the channel values right. The incorrect files must be found and corrected with 58TO57 program. After correction files must be combined with EIBCOM.EXE and CO Download Combine.EXE. After that correct data must be imported to the CO1min.mdb database. Short instructions follow

1 Find the customer download files which have seconds error

The CO1min database contains two queries [CE Stat T] and [CE Stat CO] which can be used to find the customers who have errors on download files. [CE Stat T] query counts statistics on temperature channels and [CE Stat CO] counts statistics on CO channels.

The seconds error can be found by looking such customers who have all values (average, min, max and stdev) all zero. Zero values does not necessarily mean that there is a seconds error. This must be checked from the original download files. The Expolis Access database contains query named [CE EIBEARM files] from which the download file names for each customer can be found.

2 Select the EIBEARM.EXE download files for conversion

Create a subdirectory for the correction and conversion batches. Name the directory EIB2TXTn, where n is 1-digit (or letter) batch identifier (eg. 1, 2, ..., 9, A, B, ...).

Copy all four download files for each customers, who have errors on seconds, into the subdirectory. All files must be copied because these files must be combined and imported into the CO1min.mdb database.

Rename all original download files with extension .old. (eg. 961113a1.732 -> 961113a1.732.old).

Copy or move 58TO57.EXE, EIB_COMB.EXE and CO Download Combine.EXE into the created subdirectory.

3 Edit the FILELIST.TXT and run 58TO57.EXE

58TO57.EXE reads file names and the seconds to change from a text file named FILELIST.TXT which must be located in same directory. You can edit the FILELIST.TXT - file by using NOTEPAD for instance. FILELIST.TXT must contain three columns which indicate the filename to be converted and seconds from which to change and seconds to which they will be changed, eg.

Filename	from	to
961113a1.732	:55	:57
961101a4.732	:45	:44
961101a3.732	:45	:44

Run the 58TO57.EXE (eg. Using Explorer).

Output of 58TO57.EXE tells which files were read and how many changes were made, eg.

```
File 961113a1.732: 3026 changes made.
File 961101a4.732: 3016 changes made.
File 961101a3.732: 3016 changes made.
program finished
```

58TO57.EXE renames the original files replacing letter a with @-sign, eg. 961113a1.732
-> 961113@1.732.

4 Create .TXT file for each customer

Use EIB_COMB.EXE to combine four download file into a one single text-file. Closer instructions how to use EIB_COMB.EXE are in EXPOLIS Data Management document IMPORTING CO DATA.

EIBFILES.TXT file must be edited manually.

5 Combine all .TXT data files into one file for importing

Use CO Download Combine.EXE to combine all customer data files into a one single import file. Closer instructions how to use CO Download Combine.EXE are in EXPOLIS Data Management document IMPORTING CO DATA.

6 Import new data into the CO1min.MDB

Before importing delete those customers old data from the [CO1min] table, whose new corrected data will be imported. You can delete data for instance by opening the [CO1min] - table, finding the first cid to be removed and choosing *filter by selection* and after that selecting all customers data and delete it. Other way is to make a delete query.

Import the CO1min.out -file into the [CO1min] table. Closer instructions how to import data into the CO1min.MDB are in IMPORTING CO DATA document.



KTL ENVIRONMENTAL HEALTH

Otto Hänninen

Mannerheimintie 166
 FI-00300 HELSINKI
 FINLAND

International tel. +358-9-5885 182
 International fax +358-9-4744 786
 E-mail/internet OTTO.HANNINEN@KTL.FI

EIB_COMB.EXE INSTRUCTIONS

2 Pages

27. January 1997

OH

Subj. How to use the EIB_COMB to combine/convert EIBEARM download files

Ref.

EIB_COMB.EXE is a Windows program to convert the CO data files downloaded with EIBEARM.EXE to easier form for further processing.

The main features are:

- combine 4 data channels into 1 file
- name the output according to the customer (not download date&equipment nr)

The LANGAN.EXE download program, replacing EIBEARM.EXE, produces 1 single file per customer. EIB_COMB.EXE is used to convert the already done EIBEARM.EXE downloads to the same format. Short instructions follow

1 Create customer download date & equipment list in Access database

The Expolis Access database contains query named [CE EIBEARM files] to prepare a customer list with estimated download dates and Databear serial numbers. This list can be prepared also manually as a text file. This file must be named EIBFILES.TXT.

Each line in the EIBFILES.TXT has 3 columns separated by tabs:

customer ID date of download 3 last digits of the Databear serial nr

NOTE: this procedure is based on assumption that the downloads were done using the default file name suggested by EIBEARM.EXE.

2 Select the EIBEARM.EXE download files for conversion

Create a subdirectory for the conversion batch. Name the directory EIB2TXTn, where n is 1-digit (or letter) batch identifier (eg. 1, 2, ... , 9, A, B, ...)

Move all files to be converted from the download directory to this conversion batch directory

eg. from \DATA\CO\ to \DATA\CO\EIB2TXT1

Place the EIBFILES.TXT file into the same directory.

3 Start EIB_COMB.EXE

Using command line, start EIB_COMB.EXE, giving the batch directory as a command line parameter.

Eg. EIB_COMB G:\DATA\CO\EIB2TXT1

The conversion starts. It might take a while, if you have data for several customers.

4 Further processing of converted download files

Create charts from the data using LANGAN.XLS.

EIB_COMB.EXE example output

```
-----
EIB_COMB.CPP      © Otto Hänninen 1/1997
```

A filter program to combine Expolis CO measurement results from multiple input files to 1 file per customer

Program reads EIBFILES.TXT in format

```
customer id      end_date_of_last_run      databear_serial_nr
```

and searches for the corresponding data files. When found, combines them into the Expolis CO-datafile format, having the data from all 4 channels in the same file in format:

```
date_time      CH1      CH3      CH2      CH4
```

```
-----
Reading .\EIBFILES.TXT
```

```
00091  970117.730
```

NOTE: Existing file is now overwritten: .\00091.TXT

```
.\970117A1.730  17.01.1997  18.04.09  86372 Bytes
```

```
.\970117A2.730  17.01.1997  18.04.09  86372 Bytes
```

```
.\970117A3.730  17.01.1997  18.04.09  86372 Bytes
```

```
.\970117A4.730  17.01.1997  18.04.10  86372 Bytes
```

```
-----
Serial nr 1730      PC clock      28.01.97 10:57:54
User ref  T15Bear      Last sample 17.01.97 18:00:13 *
```

```
-----
Channels      [ ] [1] [2] [3] [4] .
```

```
Sampling      60      s      .
```

```
Ext. batt      0.0      V      *
```

```
Int. batt      0.0      V      *
```

```
-----
Set  Samples  Duration  First Sample  Last Sample
  1      2969  02 1:28  15.01.97 16:31  17.01.97 17:59
  2          0  00 0:00
  3          0  00 0:00
  4          0  00 0:00
```

```
-----
Ch  Offset  Slope  Value  Sensor      Header
  1  0.000  0.500  0.0*  CO          CiTiceL
  2 -17.777  0.278  0.0*  CTemp       Cell
  3  0.000  0.050  0.0*  CO(*10)ppm High
  4 -40.000* 0.500*  0.0*  ExtTemp°C   External
```

```
_mcseries::printsummary
```

Channel	Count	Average	Minimum	Maximum	Range
Ch1	2969	1.7	0.5	14.5	14.0
Ch3	2969	1.4	0.5	12.8	12.3
Ch2	2969	22.8	14.2	24.8	10.6
Ch4	2969	21.1	-35.0	23.0	58.0

EIBFILES.TXT example listing

```
Cid      yymmdd  snr
91       970117  730
65       961203  730
94       961112  609
118      960823  609
125      961101  730
204      961115  732
```



KTL ENVIRONMENTAL HEALTH

Otto Hänninen

Esa Kaarakainen

International tel. +358-17-201 171

International fax +358-17-201 265

E-mail/internet

P.O.Box 95

FI-70701 KUOPIO

FINLAND

OTTO.HANNINEN@KTL.FI

kaarakai@hytti.uku.fi

EXPOLIS**IMPORTING CO DATA**

Data Management

5 Pages

CO data import.doc

24. November 1998 / eKa

Subj. Importing data to the CO 1min database, version 9811

Ref.

This instruction sheet describes how to import CO download files into the CO 1min.MDB database.

Four main steps:

1. Create .TXT files for each customer
2. Collect the .TXT files and combine them into one file for importing
3. Import combined data into the CO1min.mdb database

1. Create .TXT file for each customer.

LANGAN.EXE Expolis download program creates these .TXT files directly.

If EIBEARM.EXE was used to download the data from Databear, combine the 4 ASCII download files of each customer to one .TXT file

This is done using EIBCOMB.EXE according to separate instructions (see EIB_COMB.EXE Instruction sheet)

2. Collect the .TXT files and combine them into one file for importing

Move/copy all .TXT files to be imported to Access (customer files, microenvironmental measurement files, duplicates, NDIR comparisons etc.) into one directory, eg.

G:\DATA\CO\DOWNLOAD : all CO .TXT files here!

Copy or move the program file “**CO Download Combine.EXE**” into the same directory and run it (e.g. Using Explorer).

CO Download combine.exe:

CO Download file combine.exe is a program to combine CO data files to one single data file. Program reads every data line from input files and writes lines with customer id number (cid) in the output file. Name of the output file is *CO1min.out*. Cid is read from the name of the input file. Each line of output file contains six columns: cid, date, and four data channels.

Program writes information and error messages of the combining process into a log file named *CO1min.log*. Log file consists name of input files (without extensions), number of lines that were not read and number of data lines per input file.

Restrictions:

- The program file (**CO Download combine.exe**) and data files (*.txt) must be located in same directory.
- CO data files must have extension .txt and in the LANGAN.EXE download format
- If file named *CO1min.out* exist, the existing file will be overwritten.
- All cids to import must be in integer format, i.e download filenames may not contain letters. Possible duplicates must have negative value. Rename download textfiles before importing data into the CO1min database.

3. Import combined data into the CO1min.mdb database

3.1 Open CO1min.mdb in Access 7.

3.2 Select *File - Get External data - Import* from menu.

2.3 Select *Files of type: text files*

2.4 Select file *CO1min.out* to import. If the file does not appear in list, write *.out in the *File name: -box*.

2. 5 The file will be imported using *File Import Wizard*.

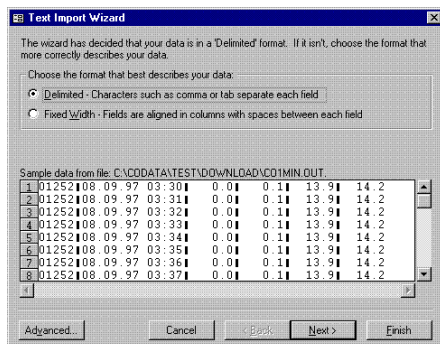
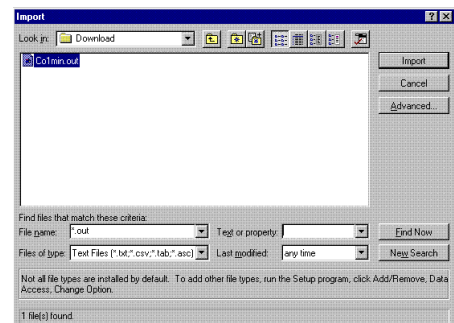

Fields in CO1min.out -file are separated by Tab.

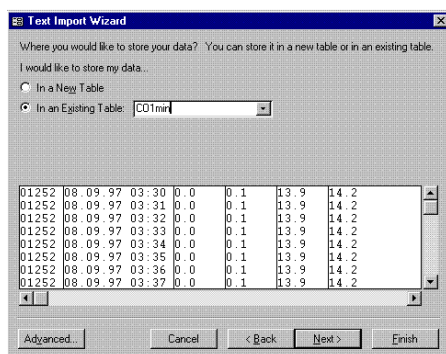
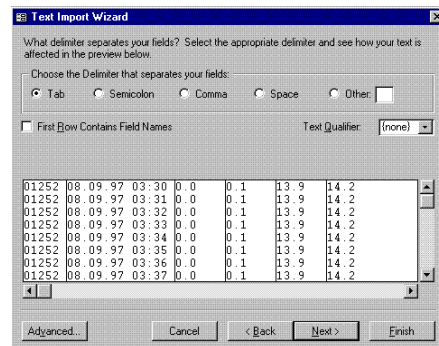

Import data into the table **CO1min**.

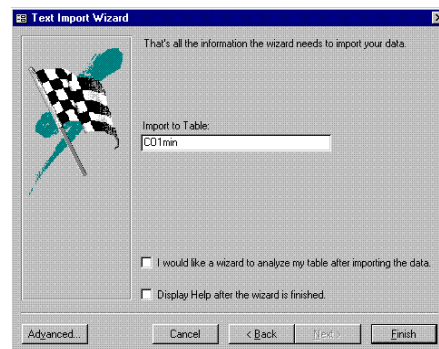

Click *Finish* button to start importing. Data importing may take a while depending on the size of imported file.

Major documents:

- Hänninen O (1996): **Expolis Data Specification**. Project document.
- Hänninen O (1996): **Expolis Data Entry**. Project document.
- Hänninen O, Koistinen K (1997): **Expolis CQN-PM2.5: How to calculate PM2.5 concentrations from the Expolis database**. Project document.
- Hänninen O, Jurvelin J, Kaarakainen E (1998): **Expolis CQN-VOC: How to calculate VOC concentrations from the Expolis database**. Project document.
- Hänninen O, Kumpulainen K (1998): **Expolis CQN-NO2: How to calculate NO2 concentrations from the Expolis database**. Project document.
- Hänninen O, Kaarakainen E (1998): **Expolis CQN-CO: How to calculate CO concentrations from the Expolis database**. Project document.
- Hänninen O, Keski-Karhu J (1998): **The FIXED and MET databases**. Project document.
- Hänninen O, Kaarakainen E (1998): **Data checking and cleaning of the CO 1 minute data**. Project document.
- Hänninen O, Kaarakainen E (1998): **Expolis Local CO Database, User's Instructions for updating to version 9811**. Project document.
- Hänninen O, Kaarakainen E (1998): **Expolis Local CO Database, User's Manual**. Project document.

Instructions sheets:

- Hänninen O (1996): **Creating a private copy of the Expolis database datafile**. Project document.
- Hänninen O (1996): **Drafting Expolis Data Management**. Project document.
- Hänninen O (1996): **EADB Installation Instructions**. Project document.
- Hänninen O (1996): **Joining the Access workgroup file to gain permissions to use the Expolis database**. Project document.
- Hänninen O (1996): **LANGAN.EXE Instructions. How to download Databear data directly in Expolis format using the LANGAN.EXE download program**. Project document.
- Hänninen O (1996): **LANGAN.XLS Instructions. How to import the CO data to LANGAN.XLS format**. Project document.
- Hänninen O (1996): **Mettler Instructions. Instructions to connect the Mettler MT5 balance to the PC**. Project document.
- Hänninen O (1996): **Moving data from Mettler Excel sheets to the Expolis Database**. Project document.
- Hänninen O (1996): **PQ100 Fake time.XLS Instructions**. Project document.
- Hänninen O (1996): **PQWLOAD.EXE Instructions. How to use Expolis download program for the PQ-100 pump**. Project document.
- Hänninen O (1996): **Using Explorer. Instructions how to use Microsoft Windows 95/NT Explorer**. Project document.
- Hänninen O (1997): **COMTEST.EXE Instructions. How to test the COM ports of a PC using COMTEST.EXE program**. Project document.
- Hänninen O (1997): **EIB_COMB.EXE Instructions. How to combine Databear download files from the EIBEARM.EXE to EXPOLIS format**. Project document.
- Hänninen O (1997): **Expolis .EXE news files**. Project document.
- Hänninen O (1997): **Importing LANGAN2 diaries to TMAD database**. Project document.
- Hänninen O (1997): **Installing the TMAD database**. Project document.
- Hänninen O (1997): **LANGAN2.XLS Instructions. How to import the CO data to LANGAN2.XLS format**. Project document.
- Hänninen O (1997): **QWin Instructions. How to use Microsoft Quick Windows programs**. Project document.
- Hänninen O (1997): **Taking personal backups**. Project document.
- Hänninen O, Kaarakainen E (1998): **58to57.EXE Instructions. How to correct mismatches in the second field in the Databear download files**. Project document.
- Kaarakainen E, Hänninen O (1998): **Static Table Update system (StaUp) instruction sheet**. Project document.
- Kaarakainen E, Hänninen O (1998): **CO Archive Manager (CAM) instruction sheet**. Project document.
- Kaarakainen E, Hänninen O (1998): **Importing CO data (CO download combine.EXE) Instruction sheet**. Project document.
- Keski-Karhu J, Hänninen O (1998): **CE Distance Queries. How to calculate distances from subject's home and workplace to the fixed ambient air quality monitoring stations and to select the closest stations for each subject**. Project document.

EXPOLIS LOCAL CO DATABASE

User's Manual

User's Instructions for Updating to version 9811

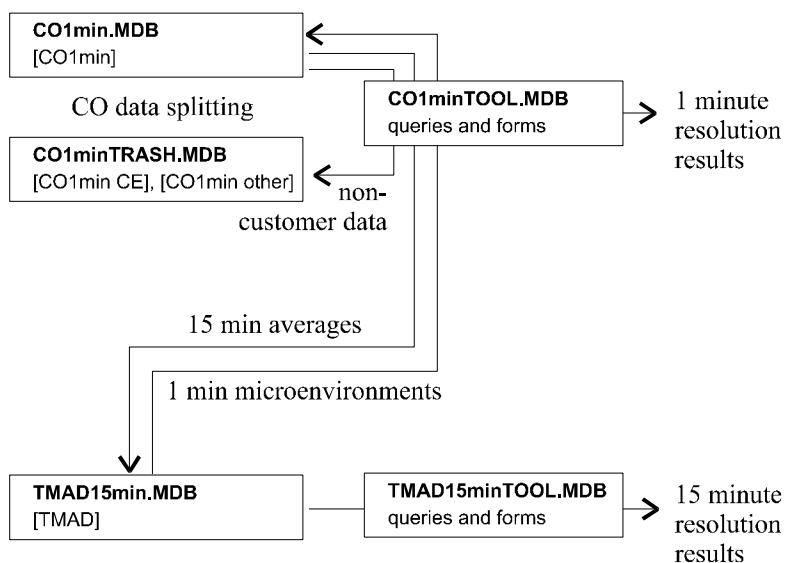

Expolis

KTL Environmental Health
P.O.Box 95
FI-70701 KUOPIO
FINLAND

Otto Hänninen

Email OTTO.HANNINEN@KTL.FI
Tel +358-17-201 171
GSM +358-400-673 207
Fax +358-17-201 265

Esa Kaarakainen

Email kaarakai@hytti.uku.fi
Tel +358-17-201 347

Contents

1. INTRODUCTION	5
PART I: STRUCTURE OF THE CO DATABASE	6
2. THE VARIABLES OF THE CQN - CO	6
2.1 Use of 'missing value' and 'non-applicable' codes in the CO database	7
2.2 Coding CO Duplicate Measurements	7
3. THE CO DATABASES	7
3.1 CO 1min.MDB database	8
3.2 CO1minTRASH.MDB database	8
3.3 CO1minTOOL.MDB database	9
3.3.1 Checking table links [DBMq Linked tables]	10
3.3.2 Queries in CO 1minTOOL.MDB database	10
3.4 CO data in TMAD15min.mdb	11
3.4.1 Tables in TMAD15minTOOL.MDB	11
3.4.2 Tables in TMAD15min.MDB	11
3.4.3 CO Queries in TMAD15min.MDB database	12
PART II: PREPARING CO DATA	13
4. CREATING PRIMARY STATIC TABLES	13
4.1 Running StaUp in the CO1minTOOL.MDB	13
4.2 Summary of Queries in the CO StaUp	15
5. CO DATA CLEANING	16
5.1 DC I: Draft Data Cleaning	17
5.1.1 Step 1: List Missing Customers	17
5.1.2 Step 2: Databear calibration check: [DC CO calibrations]	18
5.1.3 Step 3a: Lost channels: [DC Missing channels 1]	18
5.1.4 Step 3b: Lost channels: [DC Missing channels 2]	19
5.1.5 Step 3c: Channel statistics: [CE Stat CO], [CE Stat T]	19
5.2 DC II: Databear timing	20
5.2.1 Step 4: Calendar errors [DC Calendar timing]	20
5.2.2 Step 5: Databear to PC clock mismatches	20
5.2.3 Step 6: Use Databear Temperature Data for Time Calibration	21
5.3 DC III: Detailed Data Cleaning	22
5.3.1 Step 7: Recheck for missing channels with [CE Stat T] and [CE Stat CO]	22
5.3.2 Step 8: List Unexpected Peak Values in the Data	23
5.3.3 Step 9: List CO Floor Hits [DC CO Floor hits]	24
5.3.4 Step 10: List Channels with Locked Value Periods	25
5.3.5 Step 11: Missing first minutes [DC CO First 3 minutes]	25
5.3.6 Comparing TMAD data range to CO data range: [DC Range TMAD]	26
6. SPLITTING CO DATA AND MANAGING THE CO ARCHIVE	27
6.1 [Split customers only] macro	27
6.2 Discarding customer data	27
7. CREATING FINAL STATIC TABLES AFTER DATA CLEANING	28
7.1 Calculating 15-Minute Averages	28
7.2 Creating 1-Minute Microenvironments	28
7.3 PEM Run average temperatures	29
7.4 Creating other static tables	29

PART III: CO CONCENTRATION QUERIES	30
8. 1-MINUTE CO CONCENTRATION CALCULATION	30
8.1 [CO Sampling range]	30
8.2 [Co cal]	31
8.3 [CO Cal mon]	31
8.4 [CO 1min sub]	31
8.5 [CO 1min cal]	32
8.6 [UpD CO 15min Table]	32
9. CO CONCENTRATION AGGREGATE QUERIES IN THE TMAD 15 MINUTE DATABASE	34
9.1 [CO 15min customers]	34
9.2 [CO48h]	35
9.3 [CO 1h running] running 1 hour average calculation	35
9.4 [CO 1h max] maximum running 1 hour average for each customer	36
9.5 [CO 8h running] running 8 hour average calculation	36
9.6 [CO 8h max] maximum running 8 hour average for each customer	37
APPENDIXES	38
Appendix 1: CO Time Calibration	38
Appendix 2: CO Archive Manager (CAM)	38
Appendix 3: Static Table Update system (STAUP)	38
HOW TO USE [CO TIME CALIBRATION] FORM	39
TABLES, QUERIES, MODULES AND FORMS NEEDED FOR CO TIME CALIBRATION	40
[CO Time calibration] form	40
[CO Time calibration sub1] form	40
[CO Time calibration sub2] form	41
[CO Time calibration sub3] form	41
[CO Time calibration Graph] form	41
[CO Time cor] table	41
[CO sampling range] query	41
[DBMq Procs] module	41
WHAT IS CAM	42
USING [CAM] FORM (I.E. CAMMING)	42
TABLES, MODULES AND FORMS NEEDED FOR CAM	43
[CAM] form and [CAM sub CO1min] form	43
[DBMmo Procs] module	43
[DBMt CO cids all] table	43
[DBMq Cids CO1minTrash Other] query	44
[DBMq Cids CO1minTrash CE] query	44
[DBMq Cids CO1min] query	44
WHAT ARE <i>STATIC TABLES</i>?	45
USING [STATIC TABLE UPDATE FORM]	45
TABLES, MODULES AND FORMS NEEDED FOR UPDATING STATIC TABLES	47
[Static table update form] form	47
[StaUp procs] module	47
[DBMmo Procs] module	47

[DBMt Static tables] table	48
[DBMt Static queries] table	48
[DBMq StaUp table update] query	49
[DBMq StaUp table update Sub] query	49

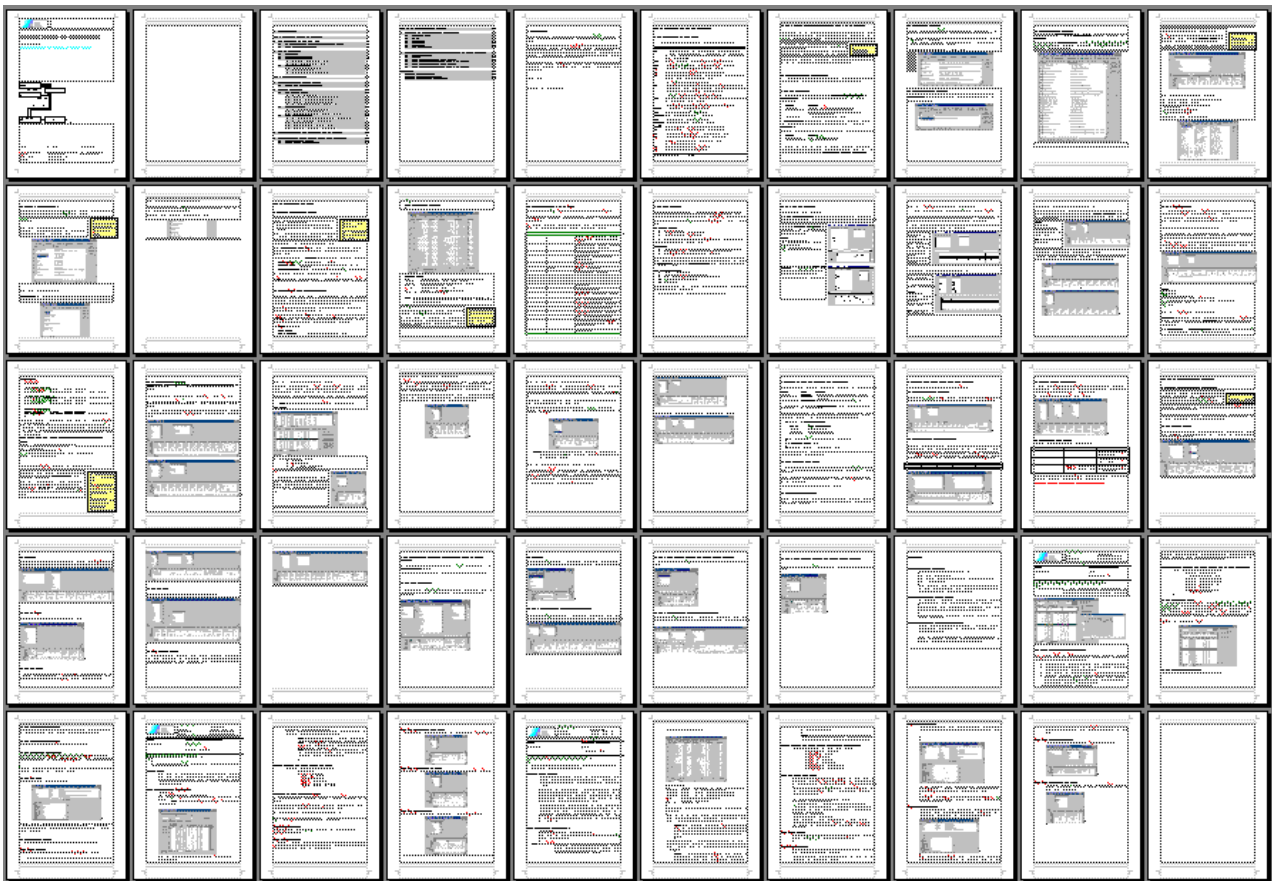

1. Introduction

CO measurement is the only air pollutant concentration measurement in the Expolis study which provides detailed time series data. The CO concentrations are continuously logged in 1-minute intervals during the 48 hour measurement period.

Data collection by a computer avoids many human errors, like mistyping numbers, but it also introduces new types errors. A simple example of a new type of error is false Databear clock setting. In this case data is collected as expected, it can be downloaded normally, and if the clock error is small enough, the customer measurement period can be extracted from the download data time series. But the timing of the data is false comparing to e.g. the time activity diary. Concentrations for different microenvironments are not correct, and if the timing error is, say, larger than a few hours, even the customer's average CO concentration will be miscalculated.

The Expolis SOP procedures try to minimize erroneous situations. The practical Helsinki data shows though that some measurements contain errors despite of the SOPs. The CO database aims to provide tools for storing the CO data in a usable form and to check the data so that at least major errors will be removed from the data before it will be used in further analysis.

30.11.1998 Kuopio

Otto Hänninen and Esa Kaarakainen

PART I: STRUCTURE OF THE CO DATABASE

2. The Variables of the CQN - CO

The key variables are presented below. The structures of each query are presented in later chapters.

Variable	Explanation
Date	In raw 1-minute data this is the minute value from the download file (with seconds truncated). In 15-minute data the date is the beginning of the averaging 15 minutes period (like in TMAD). In 1 hour and 8 hour running averages the date is the time of last 15 minutes period included in the running averaging period.
CO128	Raw [ppm] concentration 0.0 ... 128.0 in 0.5 ppm resolution (Databear channel 1).
CO13	Raw [ppm] concentration 0.0 ... 12.8 in 0.1 ppm resolution (Databear channel 3).
IntT	Raw temperature value [°C] (Databear internal temperature channel 2)
ExtT	Raw temperature value [°C] (Databear external temperature channel 4)
CO1	Combined CO concentration [ppm] of channels CO128 and CO13. This values is calculated in the [CO 1min sub] query with following immediate if -clause: CO1: IIf ([co13] =12.8 , [co128] , [co13])
CO	Calibrated, temperature corrected and [ppm] to [mg/m ³] (20°C, 760 mmHg) converted 1 minute CO concentration. CO is calculated using CO1 with the monthly average calibration factors in [CO 1min cal] query using following equation (COTCor is a Visual Basic function) CO: 1.164 * CoTCor ([CO1] ; [zmon] ; [IntT]) * [fmon]
Temp	Combined temperature values from both temperature channels, calculated from [CO1min] in [CO1min sub] query with following immediate if -clause: Temp: IIf ([ExtT] <> -99 ; [ExtT] ; IIf ([IntT] = -99 ; -99 ; [IntT]))
CO 15min	15 minute calibrated average concentration [mg/m ³].
CO1h	Running 1 hour average [mg/m ³] in 15 minute steps
CO1hmax^{*)}	Highest running 1 hour average [mg/m ³] for each customer
CO8h	Running 8 hour average [mg/m ³] in 15 minute steps
CO8hmax^{*)}	Highest running 8 hour average [mg/m ³] for each customer
CO48h^{*)}	Customer sampling range average [mg/m ³] of 15 min CO concentrations
Zero	Zero display [ppm] of the Databear CO Cell during a calibration event.
Cal	Calibration display [ppm] of the Databear CO Cell during a calibration event.
Conc	Calibration gas concentration [ppm] for each bottle used in calibrations.
f	Calibration factor calculated in [CO cal] query with following equation: f: [conc] / ([cal] - [zero])
fmon	Monthly average of the factor f for each Databear unit
zmon	Monthly average of the zero for each Databear unit

^{*)} These parameters are reported in the EU report.

2.1 Use of 'missing value' and 'non-applicable' codes in the CO database

In CO database the -9 and -8 values used for missing and non-applicable values in the EADB could be legal values for the temperature. Also it was considered that separate non-applicable code would not be necessary in CO data – this would apply in situations when the channel in question was not downloaded or measured at all. But these cases will be self evident also when coded with missing code.

The missing code was selected to be -99 for both CO and temperature channels in the raw data tables. This value should be entered into the place of any non-legal values in the raw data table [CO1min].

MISSING CODE:

The missing code in the CO database is -99.

The concentration query network will output Null value for any minutes having any of the CQN source parameters Null or missing. Thus e.g. in the 15 minute average tables missing values are presented as missing records and/or Null values in the fields.

The aggregate functions in the 15 minutes database do not filter missing values from their source data. Thus any missing codes used in the 15 minutes database would erroneously reflect to the output variables.

2.2 Coding CO Duplicate Measurements

The CO duplicate measurements should be coded using negative CID value. Thus the duplicate CO measurement for customer 12345 would be -12345. The corresponding download file would be named -12345.TXT

3. The CO databases

The actual CO measurement results are stored in three databases: **CO1min.MDB**, **CO1minTRASH.MDB** and **TMAD15min.MDB**. The relationships between these databases are shown in the cover of this document and are summarized here:

Database	Contents
CO1min.MDB	1 minute raw data [ppm] for customers (main data file)
CO1minTRAHS.MDB	1 minute raw data [ppm] for non-customers (archive file) – customer data before and after the case is taken to/from customer – tests and other measurements
TMAD15min.MDB	15 minutes average calibrated [mg/m ³] data

The **CO1minTRAHS.MDB** is an archive file. All CO data that is not actively used is moved there. A separate tool, CO Archive Manager (CAM) is available for moving data sections between the archive and the main database **CO1min.MDB**.

The queries built in the previous version of the database files have been moved to separate tool databases. These are

Database	Contents
CO1minTOOL.MDB	Queries processing 1-minute data
TMAD15minTOOL.MDB	Queries processing 15 minute data

The tool databases link to several tables in the local EADB data database (e.g. ATHENS.MDB) and TMAD15min.MDB. When installing the CO database, these links must be updated in both of the tool files to point correct data database files. This is described in detail in **User's Instructions for Updating to Version 9811**.

3.1 CO 1min.MDB database

CO1min.MDB is the main database for 1 minute raw CO data. Data in this database is used in calculating 15 minute statistics in TMAD15min.MDB and then longer time averages from there on. Non-customer data, that is

- data from customer download files that was recorded before the case was taken to the customer or after the case was taken away from the customer or
- data from non-customer downloads (tests, microenvironmental measurements) are moved to an archive file CO1minTRASH.MDB for any needed later reference.

Tables in the CO1min.MDB database are shown in the picture on right.

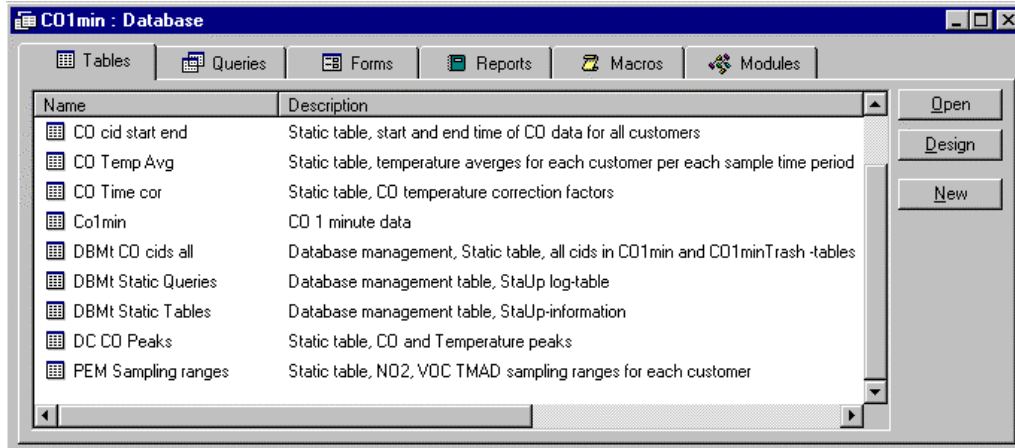

3.2 CO1minTRASH.MDB database

After the data cleaning customer's non-measurement period data and non-customer data are moved from to the CO1minTRASH.MDB database. This database contains two tables for storing the above mentioned data types.

Tables in CO1minTrash.mdb:

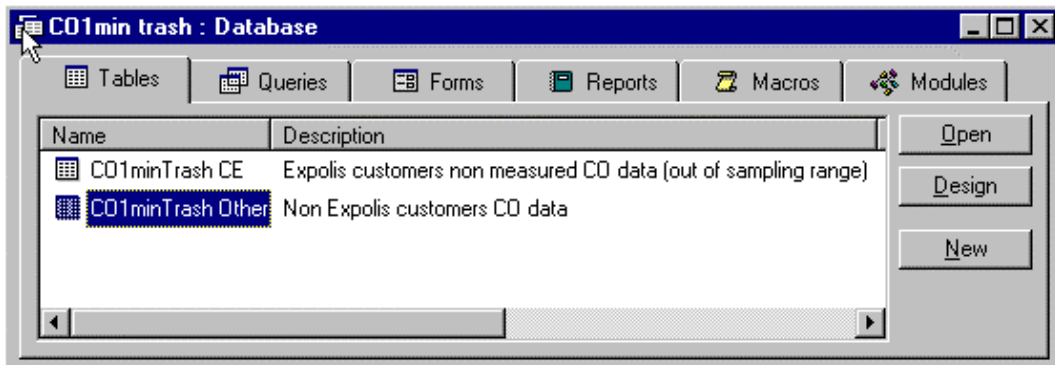

3.3 CO1minTOOL.MDB database

Interface for all CO-data is **CO1minTOOL.MDB** database. This database contains no actual data tables. All tables are links to data databases, including the CO databases, **TMAD15min.MDB** database or local Expolis database, e.g. **ATHENS.MDB**.

Next picture shows table links in **CO1minTOOL.MDB** database. The text in the *Description* –column shows where the table should be linked to. Note that this text does not show where the table really is linked to. Use Linked Table Manager to view and change link destinations.

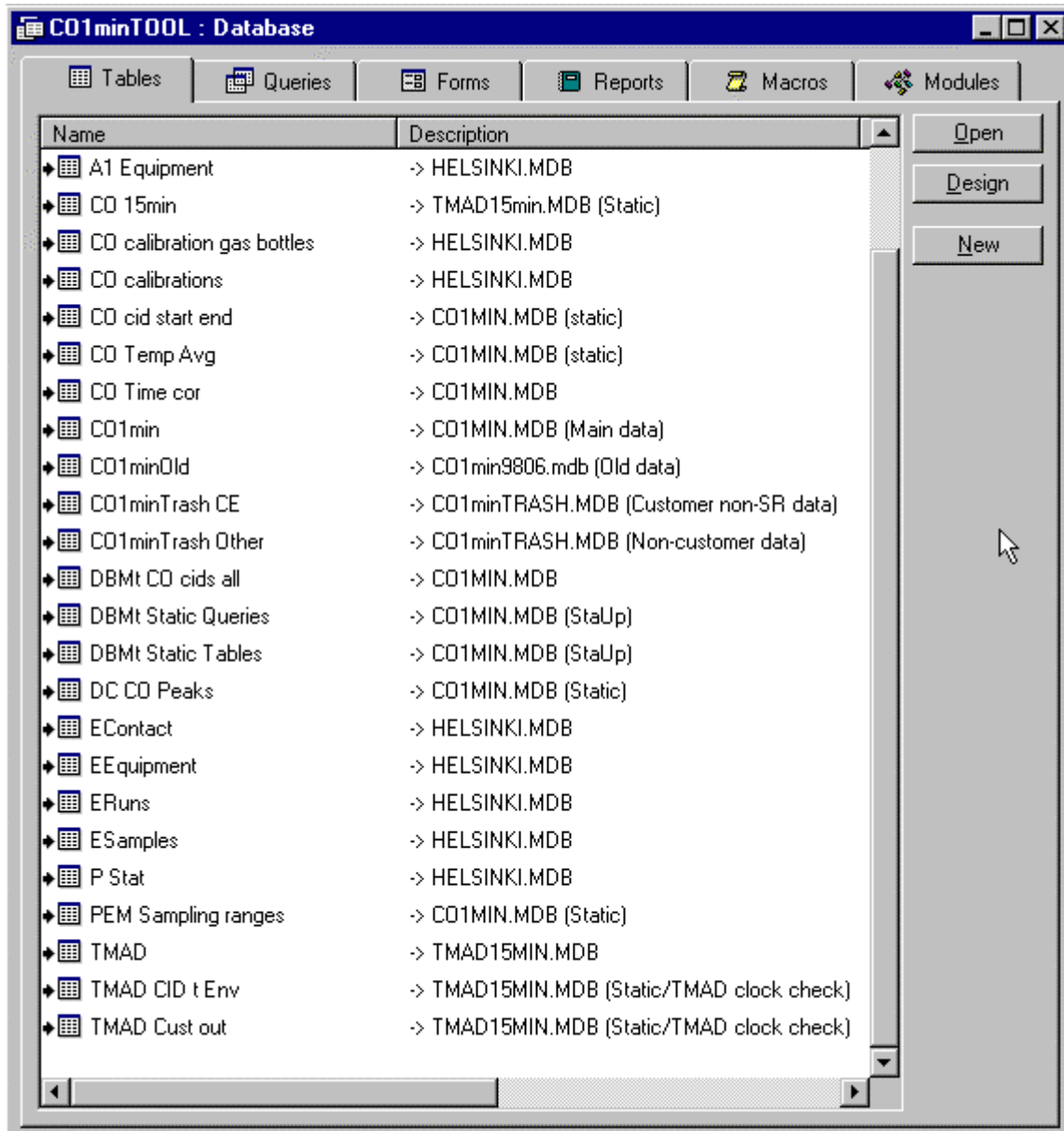

3.3.1 Checking table links [DBMq Linked tables]

Query [DBMq Linked tables] lists all linked tables, source databases and source tables. The output of this query is similar to the **Linked Table Manager** dialog view. The output does not show, if the destination table really exists.

This query can be used for checking database links. If a query or a table does not function properly, it might be because one or more table links are not correct.

NOTE:

It is on the User's responsibility to make sure that the links point to correct versions of data databases.

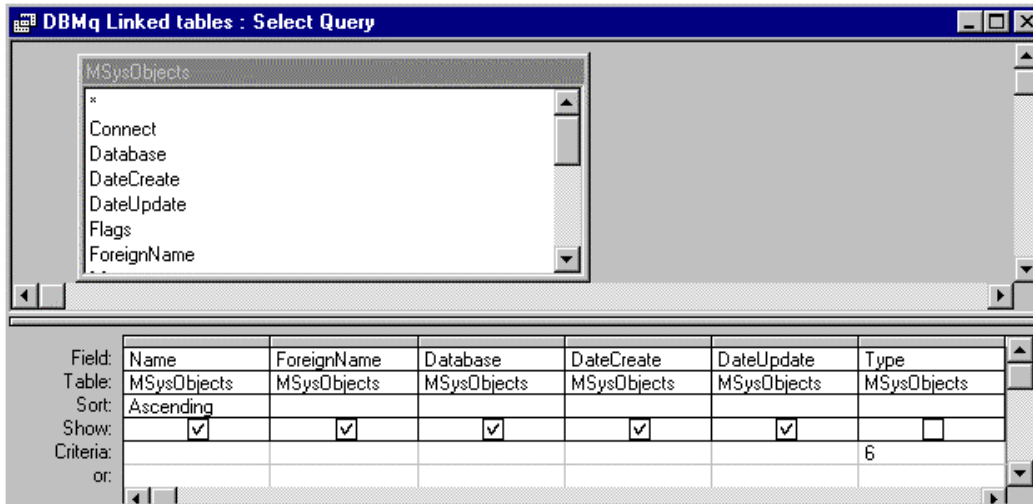

3.3.2 Queries in CO 1minTOOL.MDB database

Queries in the CO 1minTOOL.MDB database belong to one of five groups:

- data cleaning after importing raw data (DC)
- the CO 1-minute CQN and 15 minute average calculation
- sub-queries (Sub)
- database management queries (DBMq) or
- static table update queries (UpD).

Next Picture shows all queries in CO1minTOOL.MDB:

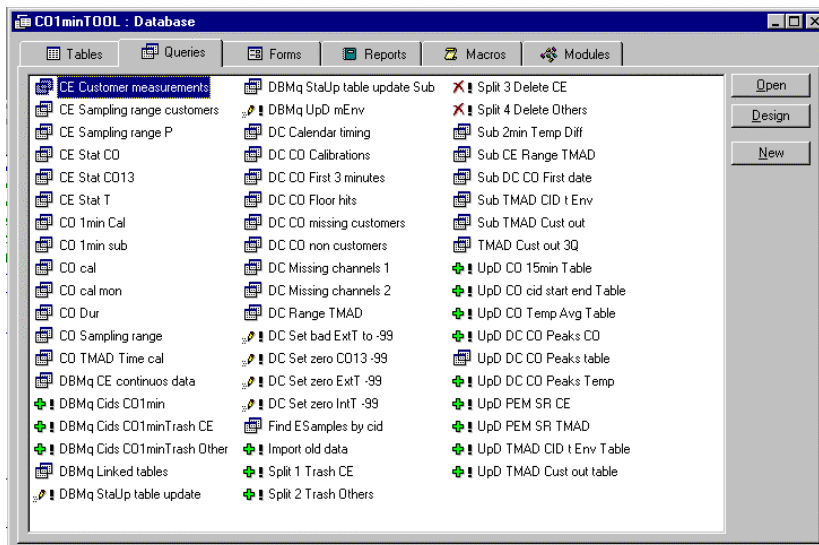

3.4 CO data in TMAD15min.mdb

After data cleaning and splitting the CO data the calibrated 15 minutes CO concentration statistics are inserted into the TMAD15min.mdb database, the [CO15min] table. The 15 minute data are in [mg/m³].

All longer period data, like 1 hour, 8 hour and 48 hour averages are calculated using the 15 minute data.

NOTE:

CO results calculated by the previous version of the database and reported to EU in summer 1998 were in [ppm]

3.4.1 Tables in TMAD15minTOOL.MDB

Next picture lists all tables in CO15minTOOL database. This is a tool database and it contains no actual tables, all tables are linked from other databases.

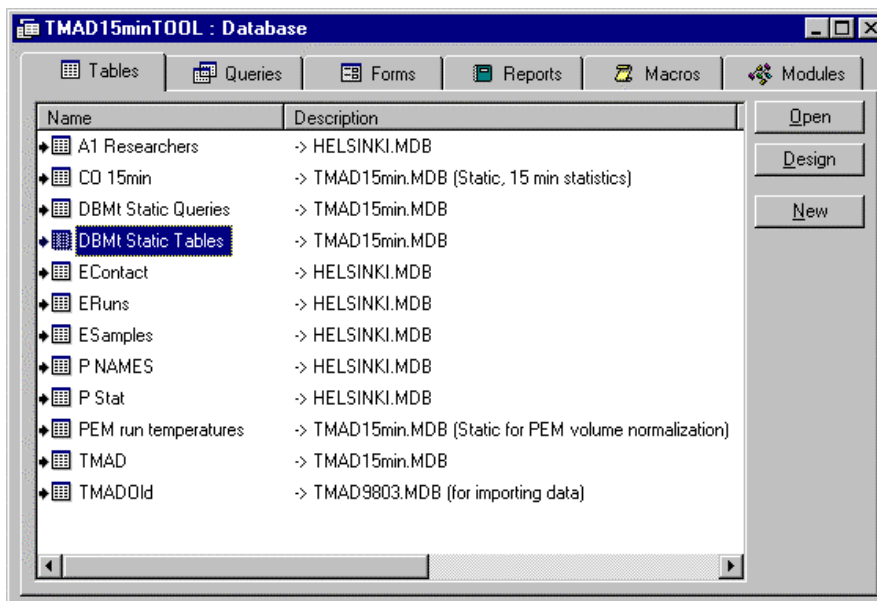

3.4.2 Tables in TMAD15min.MDB

TMAD15min.MDB is data database. It contains only tables. All queries and forms are in TMAD15minTOOL.MDB.

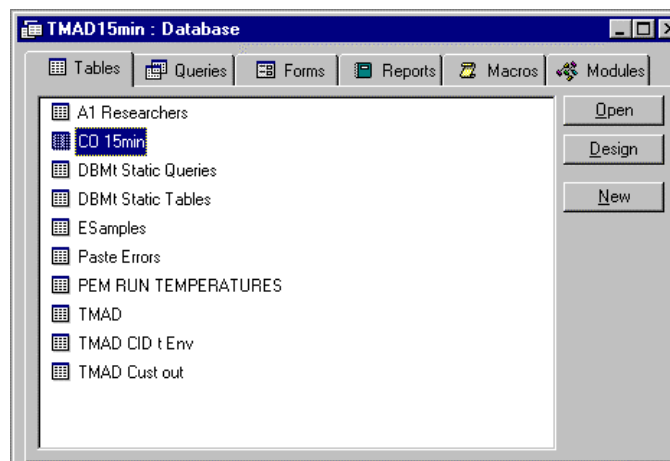

3.4.3 CO Queries in TMAD15min.MDB database

CO queries in the TMAD15 min database calculate customer data for the exposure customers. These include customer 15 minutes concentrations, running 1 hour and 8 hour averages and maximums of both of these, as well as 48 hour average CO exposure concentration for each customer.

The Date field in these data is the end time of corresponding averaging period.

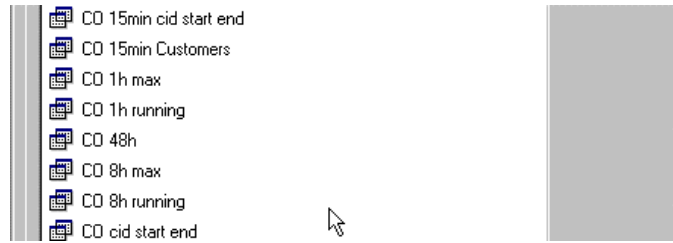

PART II: PREPARING CO DATA

4. Creating primary static tables

Earlier in the **Expolis Access Database (EADB)** system only the raw data items were stored in tables. All calculated values were dynamically calculated from these data tables. This system ensures that

- all calculation are performed in the same way (that is, correctly)
- all corrections to the data entry are reflected to all values calculated from the database

Now with the CO and ambient data some data tables in the Expolis database grow so big that computer performance becomes a limiting factor and the dynamic calculate-always-from-raw-data-items –approach is not practical. In these cases the calculated values must be stored in a result table in the database. As the values in these tables are stored and the data does not change when the source data are edited, the tables are called *static*.

NOTE: new type of tables is introduced to the Expolis database system

Calculated values are stored in tables for computer performance reasons. These tables are called *Static*.

A special **Static Table Update System (StaUp)** was developed for updating and managing the data in these static tables. Database users should be aware, that data in these tables do not reflect the latest corrections to the basic measurement data.

After the importing the raw data into the **CO1min.MDB**, three primary static tables must be updated. These tables are:

[CO cid start end]	start and end time of CO data for each cid
[TMAD Cid t Env]	TMAD microenvironments as text format for each 15 minutes period from TMAD.MDB
[PEM Sampling ranges]	measurement time ranges for each cid from local data.MDB (e.g. ATHENS.MDB)

These tables are needed in several queries and are created for speeding up performance.

Use **StaUp** system for inserting data into these tables. Select all tree tables, [CO cid start and], [TMAD Cid t Env] and [PEM Sampling ranges] for update. There is no need to update other tables at this point – deselect all other tables.

4.1 Running StaUp in the CO1minTOOL.MDB

A new data structure and set of tools were developed for managing tables that contain calculated values ('static tables'). Running a set of predefined queries creates the data in these tables. These queries pull the values from defined source tables and perform necessary calculations to produce the result records. Later if the source tables are edited, e.g. in data cleaning procedures, the target tables must be updated to reflect the changes in the source tables.

Some of the StaUp queries are long lasting. You can use duration field to determine whether you should run those queries overnight. Duration field stores the length of last run.

A separate more detailed documentation "StaUp documentation" is available for the data manager to manage and use the **StaUp** system. Here only a short summary is given to show how to run **StaUp** and thus keeping the target tables up-to-date. **StaUp** keeps also a record of the run times of different queries. Some of these are quite lengthy and should be run overnight. You can consider the previous run times when thinking of updating a static table.

To run **StaUp** do the following:

- 1 Open Access
- 2 Log on as LADMIN (NOTE: You need to have rights to delete data)

3 Open the tool database

4 Open [Static table update form] form

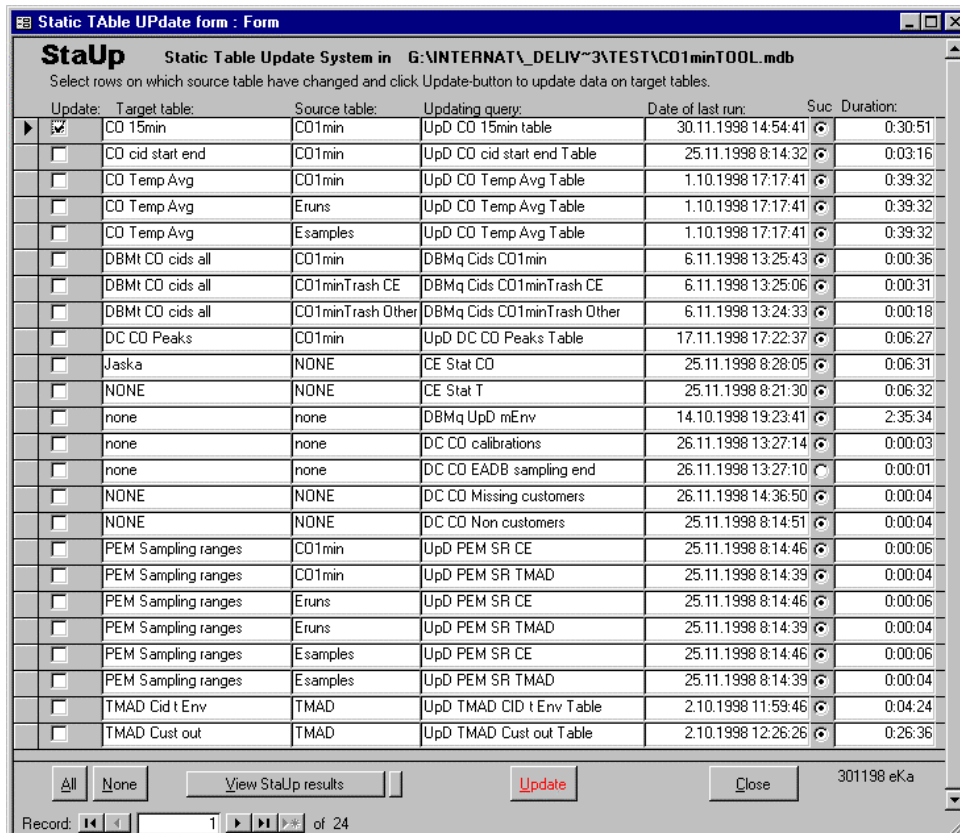

Fields of the form:

- Update = select this to delete all data from target table and execute the append query
- Target table = name of the target table which will be cleared and rebuilt
- Source table = name of the source table from which the data will be calculated
- Append query = name of the query which will be run
- Last run = time when the append query was last run
- Suc = indicator if the last run was completed successfully
- Length of run = Duration of last run [hh:mm:ss]

NOTE! Duration field may display peculiar values. Reason for this might be the Regional Settings of your computer. The form was designed using Finnish settings. At least with English (US) settings duration field did not display values right.

5 Select the targets you want to build or update

When the Update-button is clicked contents of all checked target tables are deleted and the queries listed in the append query column are executed.

When you check an Update box on one row, all rows having the same target table are checked, because the target is first fully cleared and multiple queries probably need to be run to re-built the target. If this is not what you intend to do, you can de-check unwanted rows.

NOTE: When a query fails, the table [DBMt Static queries] contains error information.

Find the reason why the query was not successful, fix the error and run the update query again.

4.2 Summary of Queries in the CO StaUp

The next table summarizes the queries included in the CO database Static Table Update System (StaUp).

The queries calculate values that are stored in static tables. Values in these tables do not change 'automatically' – if data cleaning changes old data in the database or new data is imported, the static tables must be manually updated, preferable using the StaUp.

StaUp automatically clears all selected target tables when user requests an update. The queries themselves do not empty the target tables; thus a query when run over existing data, will fail, if the table is not first cleared.

Target	Query	Comment
CO 15min	UpD CO 15min table	Calculate 15 minute statistics into the [CO 15min] table. This query should be run once after data cleaning is finished and the database has been splitted
CO cid start end	UpD CO cid start end Table	Update [CO cid start end] table. This table is used to speed up some queries and must be updated after importing new data into the database
CO Temp Avg	UpD CO Temp Avg Table	Calculate PEM sampling run temperature averages for volume normalization.
DBMt CO cids all	DBMq Cids CO1min	Insert all cids from [CO1min] into [DBMt CO cids all] table]. This table is used by the CO Archive Manager (CAM)
-“-	DBMq Cids CO1minTrash CE	Insert all cids from [CO1minTrash CE] into [DBMt CO cids all] table]
-“-	DBMq Cids CO1minTrash Other	Insert all cids from [CO1minTrash Others] into [DBMt CO cids all] table]
DC CO Peaks	UpD DC CO Peaks Table	Update [DC CO Peaks] table. Contents of this table are needed for finding CO peaks.
NONE	CE Stat CO	DC query: summary statistics.
NONE	CE Stat T	DC query: summary statistics.
NONE	DBMq UpD mEnv	Updates mEnv-field in CO1min table using TMAD '1-cross' rows.
PEM Sampling ranges		This table is used to store filter+VOC, NO2, TMAD and CO sampling ranges.
	UpD PEM SR CE	Update [PEM Sampling ranges] table for personal microenvironment measurement time ranges.
-“-	UpD PEM SR TMAD	Update [PEM Sampling ranges] table for Time Activity diary measurement time ranges.
-“-	UpD PEM SR CE	Update [PEM Sampling ranges] table for personal microenvironment measurement time ranges.
-“-	UpD PEM SR TMAD	Update [PEM Sampling ranges] table for Time Activity diary measurement time ranges.
-“-	UpD PEM SR CE	Update [PEM Sampling ranges] table for personal microenvironment measurement time ranges.
-“-	UpD PEM SR TMAD	Update [PEM Sampling ranges] table for Time Activity diary measurement time ranges.
TMAD Cid t Env	UpD TMAD CID t Env Table	This table is used for storing TMAD microenvironment as text. Used for calculating TMAD time ranges and by TMAD - Databear clock comparison form.
TMAD Cust out	UpD TMAD Cust out Table	This table is used by TMAD - Databear clock comparison form

5. CO Data Cleaning

After importing 1 minute raw download data into the CO 1 min database, the first thing to do is to check that all measured customers did come into the CO database, that they have data for all Databear channels and that the corresponding calibrations have been entered to the EADB. This first stage of datacleaning is called Draft data cleaning.

The aim of DC I: Draft Data Cleaning is to ensure, that the following datacleaning stages are performed on all available data.

DC I: Draft Data cleaning

- 1 List missing customers
- 2 List Databears with missing monthly calibrations
- 3 List customers with missing Databear channels

The second thing to do in data cleaning is to check the timing of Databear data. Timing must be checked before the download data is split into customer and non-customer data.

DC II: Timing

- 4 List customers with calendar level timing errors (some or no CO data in PEM sampling range)
- 5 List customers with Databear to PC clock mismatch (Langan.EXE downloads only)
- 6 Check Databear timing using temperature channel data (CO tcal form)

A time correction procedure can be run after checking for timing errors, if the timing error can be tracked in previous steps 5-6. After the timing of all downloaded data has been checked and corrected, the CO database is split into the main data in **CO1min.MDB** and the archive data in **CO1minTRASH.MDB**. The final detailed data cleaning can be done only after splitting the data.

DC III: Detailed Data Cleaning

- 7 Re-check for missing channels
- 8 List and correct unexpected peak values in the data
- 9 List CO floor hits (Databear has possibly lost below zero CO data)
- 10 List channels with locked-value periods
- 11 Other checks

Any data found non-reliable in any step of the data cleaning must be removed from the main CO database. This can be done e.g. using the CO Archive Manager (CAM).

The following sections describe the data cleaning stages I-III and steps 1-10 in more detail.

5.1 DC I: Draft Data Cleaning

5.1.1 Step 1: List Missing Customers

The query [CE Customer Measurements] should be edited in each center to output all Expolis exposure customers (nominal count being 50, true count in Helsinki 201). This query must be edited to function correctly before proceeding.

The query [DC CO Missing Customers] lists all EADB customers, using [CE Customer Measurements] query, which do not have CO data at all in the 1 min database. The download files of these customers were not included when importing the CO data.

Actions:

- 1 Print the output of this query.
- 2 Try to find the download files of these customers
- 3 Import the found files
- 4 Explain why data is missing for the rest
- 5 Rerun this query, if some customers were found

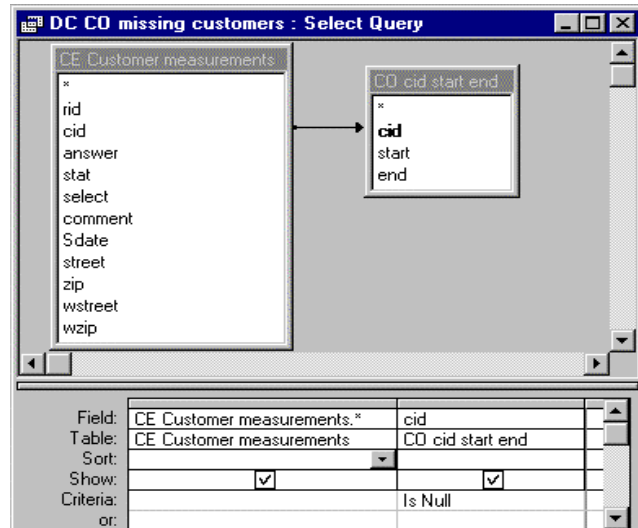

For data management purposes, the query [DC CO Non-Customers] lists all measurements which are not Expolis customers. These are e.g. duplicates, test measurements, pilots or microenvironmental measurements.

Print also the output of this query for later reference.

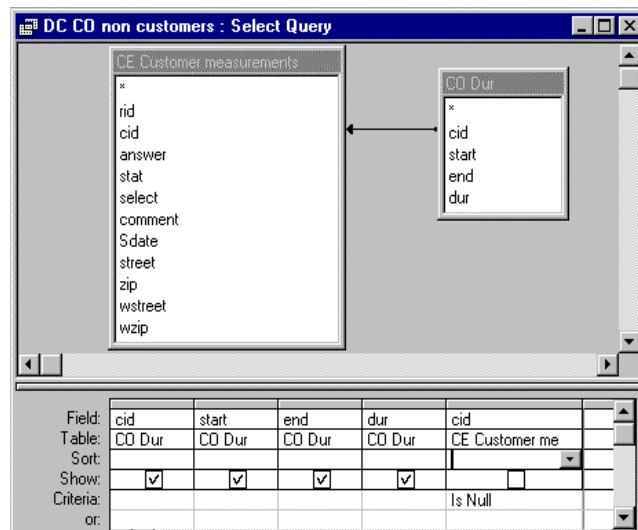

5.1.2 Step 2: Databear calibration check: [DC CO calibrations]

The CO CQN uses monthly average calibration terms for CO standard gas and zero levels of each Databear unit.

It is on the responsibility of each center to check if the monthly average calibration terms are applicable for their data. If substantial jumps have occurred between successive calibrations, or the calibration of the unit has been manually adjusted, the monthly average calibration terms might not be appropriate for some measurements.

The query [DC CO calibrations] lists CO measurements for which corresponding monthly calibration factor averages cannot be calculated because of missing calibration entries in the EADB:

Actions

- 1 Print the output
- 2 Check if you can find calibration values for the missing months
- 3 If, enter them in the EADB
- 4 Use the previous and following month values to interpolate the missing values if no true data is available
- 5 or discard the measurement (remove the data to the archive)

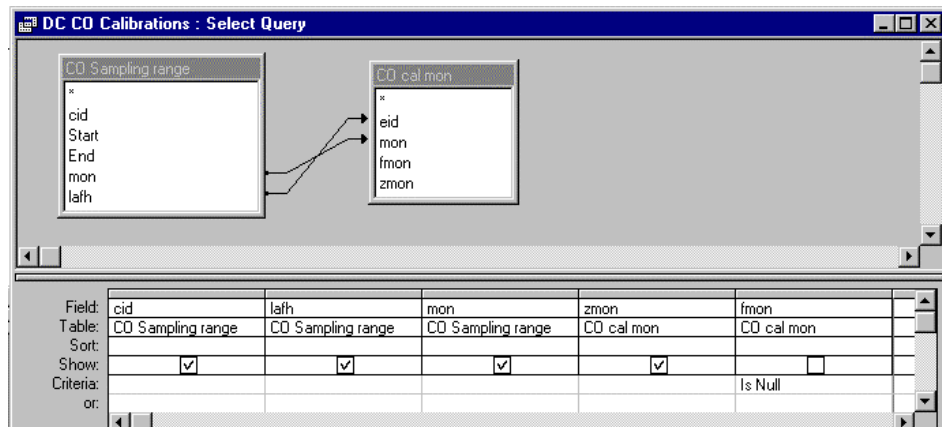

5.1.3 Step 3a: Lost channels: [DC Missing channels 1]

The LANGAN.EXE download files have 0-values in fields indicating missing channel.

The values of these cases must be replaced with missing code -99.

Actions

- 1 Print the output
- 2 Check if you can find any of the missing download data
- 3 if, import it
- 4 if no, replace values with -99
- 5 rerun this query

NOTE! The execution of this query may take a while.

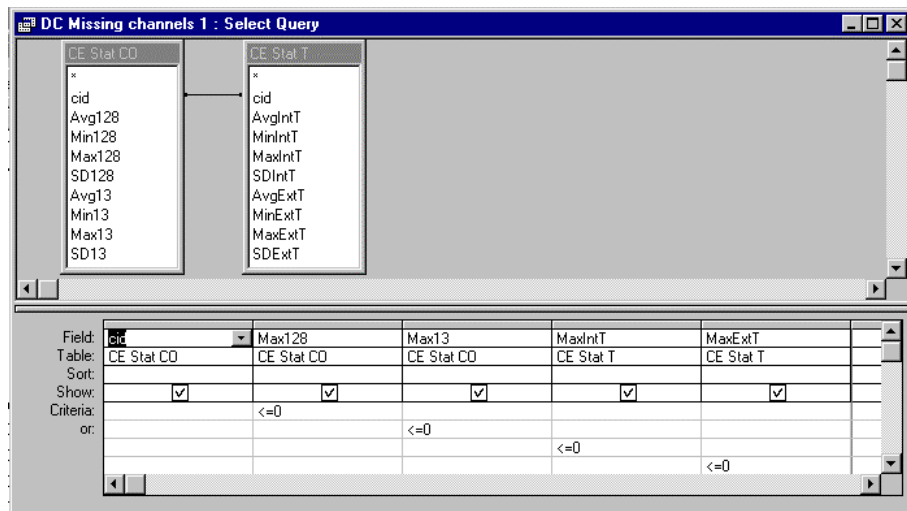

5.2 DC II: Databear timing

The CO SOP tries to minimize situations where the Databear clock would be falsely set. The LANGAN.EXE download program also compares the Databear clock to the PC clock and indicates any mismatches.

In practice though, the Helsinki data shows that despite of the SOPs, some timing errors are present in the download data. This section describes tools that can be used to find suspicious CO timing in the database.

5.2.1 Step 4: Calendar errors [DC Calendar timing]

The first step in checking the CO timing is done using [DC Calendar timing] query. This query lists customers for which the CO download data misses some data in the beginning or at the end of the customer measurement (the period when the PEM case was with the customer according to the sample runs in the EADB).

The [cov] field shows in days for how long period during the PEM measurement there seems to be CO data available. Because the Databear has been by the customer as long as any PEM sampling took place, all these cases indicate some kind of error either in the Databear timing, or in the downloading.

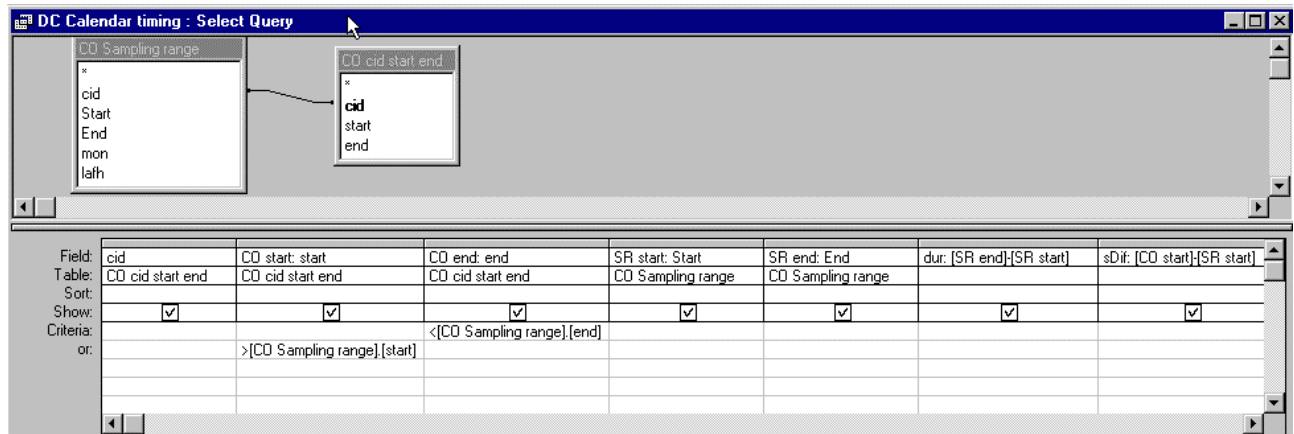

Actions:

- 1 Print the output
- 2 Explain the errors
- 3 Import any missing but available data
- 4 Enter timing correction factors in table [CO time cor] if possible
- 5 Run the time corrections using [CO time calibration] form (explained in the Appendixes)
- 6 Remove all non-correctable erroneous data
- 7 Rerun this query

5.2.2 Step 5: Databear to PC clock mismatches

If LANGAN.EXE download program was used, it is possible to list timing mismatches between the Databear clock and the download PC clock from the download files. The **TIME_ERR.BAT** batch program reads the downloaded .TXT files and outputs 2-3 lines per each file indicating the type of download program originally used and if any timing mismatch exists.

Copy the **TIME_ERR.BAT** to the **DATA\CO\DOWNLOAD** directory where you have collected all the "12345".TXT files for importing them into Access. Run the batch there by double clicking it in Explorer.

The following listing shows the three types of output cases that can be found the **TIME_ERR.TXT** file created by the **TIME_ERR.BAT**:

```

Time_err.bat

----- 00001.TXT
Serial nr 1609      PC clock    19.02.97 08:59:48
User ref  NewBear   Last sample 19.02.97 08:59:44  ·(No error in timing)

----- 00014.TXT
00014960821.609  Combining following EIBEARM files : (EIBEARM.EXE used:)
Serial nr 1609      PC clock    27.05.97 08:45:45
User ref  T15Bear   Last sample 21.08.96 10:22:32 * (cannot tell about timing)

----- 00273.TXT
Serial nr 1605      PC clock    25.07.97 16:00:23
User ref  NewBear   Last sample 23.07.97 14:59:04 * (2-day error in timing)

```

- (1) The first case (0001) has no '*' after the Last sample time. This means that during the download, the Databear and the PC clocks were in same time
- (2) The second case (00014) has the '*' indicating the time mismatch, but the first line says: "Combining...". This means that this .TXT file was created from the EIBEARM.EXE download files, and the PC clock shows the PC time when the files were combined. THIS CANNOT TELL US ANYTHING ABOUT THE POSSIBLE TIMING MISMATCH DURING THE DOWNLOAD. EIBEARM.EXE download cases should be checked with two other timing check tools.
- (3) **The third case (00273) shows a sample of LANGAN.EXE download with 2-day timing error**

Actions

- 1 Go through the TIME_ERR.TXT file and pick up cases like (3) above
- 2 Use [CO time calibration] form, described in the Appendixes to see whether you can come up with a time correction factor for these customers
- 3 if you can, enter the factors into table [CO time cor]
- 4 Run the time corrections using [CO time calibration] form (explained in the Appendixes)
- 5 Remove all non-correctable erroneous data

5.2.3 Step 6: Use Databear Temperature Data for Time Calibration

Steps 4-5 indicated cases where some timing error in the downloaded data is evident. A form was developed to check these and other cases for timing errors and for correcting for them. This form is called [CO time calibration], and it is described in detail in the Appendix.

This form shows the PEM sampling ranges in the upper part of the screen and the corresponding raw CO and temperature data in the lower part of the screen. In between can be seen the [CO time cor] table. The possible time correction to be added to the Databear download timings [in minutes] can be entered into this table. Pressing the Correct Current Customer –button adds the correction factor the the timings.

NOTE

The time correction should be run into the whole downloaded data.

Later when the CO database has been splitted into main and archive databases, the archive section should be first moved to the main database.

After running the time correction, the archive section can be moved back to the archive database.

5.3.2 Step 8: List Unexpected Peak Values in the Data

In case of errors in electrical connections inside the Databear, some times the Databear channel values hit the ceiling or the floor of the channel range. Typically these can have only 1-minute duration, but of course some times it is possible to have a longer period of such data. These data values should be replaced with missing code –99.

A query and form based tool was developed for finding this kind of situations. Form [Peaks] lists these peaks. CO peak limit (sudden change) is 10 and temperature peak is 5. Static table [DC CO Peaks] is used for storing these peak values.

NOTE! Table [DC CO Peaks] must be updated using StaUp before you can use this form.

[Peaks] form:

Record: 49 of 395

cid	COdate	CO128	CO13	IntT	ExtT	mEnv
273	18.7.1997 14:02:00	2	2.1	26.4	27.8	
273	18.7.1997 14:03:00	2	2.1	26.4	27.8	
273	18.7.1997 14:04:00	2	2.1	26.4	27.8	
273	18.7.1997 14:05:00	2	2.1	26.4	27.8	
273	18.7.1997 14:06:00	2	2.1	26.4	27.8	
273	18.7.1997 14:07:00	127.5	12.8	53.1	53.1	
273	18.7.1997 14:08:00	127.5	12.8	53.1	53.1	
273	18.7.1997 14:09:00	127.5	12.8	53.1	53.1	
273	18.7.1997 14:10:00	127.5	12.8	53.1	53.1	
273	18.7.1997 14:11:00	127.5	12.8	53.1	53.1	
273	18.7.1997 14:54:00	2	2	26.1	27.3	
273	18.7.1997 14:55:00	127.5	12.8	53.1	53.1	

Record: 586 of 7680

Record: 1 of 1

Peaks

Short instructions:

0. Execute query [UpD DC CO Peaks table] if needed
1. Select peak from upper grid, lower grid displays CO1min data for that time.
2. Replace incorrect value in lower grid with error code -99 and enter values to OK- and rid-fields in upper grid.

Peaks –form needs following database objects:

- [Peaks] form,
- [Peaks subform1],
- [UpD DC CO Peaks table] query and
- [DC CO Peaks] table (static).

[UpD DC CO Peaks table] query:

This query updates [DC CO Peaks] table. Actual update is done by using function *FindPeaks* from module [CO module]. Peaks are stored in a static table because of execution time of this query is long and the [Peaks] form would be unpleasant to use. *FindPeaks* function stores the peak values straight into the [DC CO Peaks] table. This query is done only for the reason that [DC CO Peaks] table can be updated using StaUp.

Field: cid
Table: CO cid start end
Sort:
Show:
Criteria: FindPeaks()
or:

5.3.3 Step 9: List CO Floor Hits [DC CO Floor hits]

The Databear is not capable of showing negative values for the CO channels 1 and 3. If the zero level is adjusted too close to zero, the Databear might roam downwards or the temperature response of the CO sensor in colder conditions might lead the sensor to show negative voltages. As the Databear cannot store negative values, these situations are shown as zero concentrations. If both of the CO channels show zero, then the true concentration display might be also below zero, and thus the result might not be quite precise.

This query lists measurements that include CO floor hits. If considered necessary, the CO time series close to the floor hits might be looked at manually. If the data shows that the floor hit is 'deep', the measurement might be discarded. At least the output of this query should be printed and included in the CO data cleaning documents.

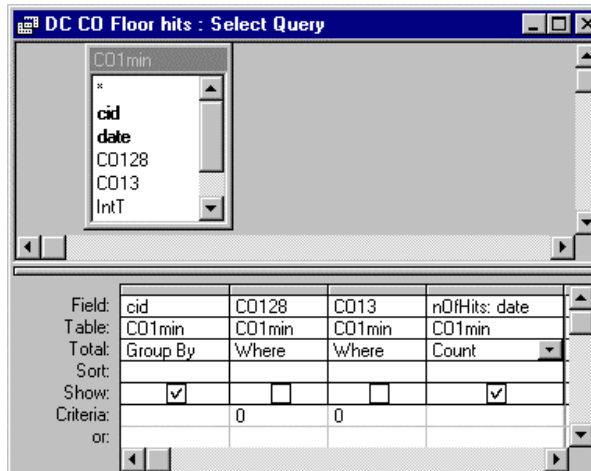

5.3.4 Step 10: List Channels with Locked Value Periods

Electrical failures in the Databear might lead to situations where one or more Databear channels show floor/ceiling/other locked value for a period of time. These can be inspected using the 15 minutes statistics stored in the TMAD15min.MDB in [CO 15min] table. Looking at running 1-hour minimums and maximums, if these are equal, it indicates a potential locked value problem. All locked values (min = max) are not necessarily problem values, eg. in the night.

Because this query is based on 15 minutes data, this query is located in the TMAD15minTOOL.MDB, and the 15 minutes statistics calculation query must be run before this query.

The locked value periods should be replaced in the 1-minute data with -99 missing value code, or the whole measurement should be discarded. If some data is edited or discarded in this data cleaning step, the 15 minute data must be recalculated using StaUp.

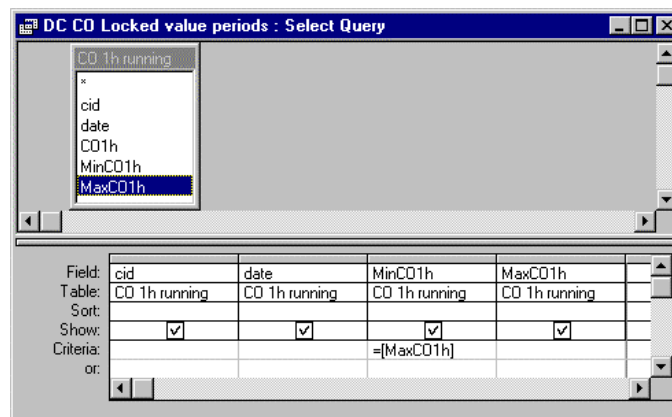

NOTE! 15 minutes values must be updated before running this query. Use StaUp to calculate 15 minutes values as described in chapter 7.1. After that you can open TMAD15minTOOL.MDB and run query [DC CO Locked value periods]

5.3.5 Step 11: Missing first minutes [DC CO First 3 minutes]

In some cases the CO data in Databear channel 1 starts 1-2 minutes earlier than data in the other channels. This is an undocumented error in the Databear. In this case the channels 2-4 might have 0-values for the first 1 – 2 minutes in the raw data. If the channel statistics show zero minimums for some of the channels 2-4, it might be caused by this type of error in Databear timing, and it could be corrected by entering missing values for the zero channels or by removing the first couple of minutes altogether from the database. This problem should not occur after the split is done.

This query lists approximately first 3 minutes data for all cids in [CO1min] table.

DC CO First 3 minutes : Select Query

Field:	cid	date	CO128	CO13	IntT	ExtT	
Table:	CO1min	CO1min	CO1min	CO1min	CO1min	CO1min	
Sort:	Ascending	Descending					
Show:	<input checked="" type="checkbox"/>	<input checked="" type="checkbox"/>	<input checked="" type="checkbox"/>	<input checked="" type="checkbox"/>	<input checked="" type="checkbox"/>	<input checked="" type="checkbox"/>	<input type="checkbox"/>
Criteria:		>=[firstofdate] And <=[firstofdate]+(2.5/24/60)					
or:							

5.3.6 Comparing TMAD data range to CO data range: [DC Range TMAD]

DC Range TMAD : Select Query

Field:	cid	CO Dk	Comment	Start	End	CO Start: start	CO End: end	spl
Table:	PEM Sampling ra	PEM Sampling ra	PEM Sampling ra	PEM Sampling ra	PEM Sampling ra	CO cid start end	CO cid start end	PEM Sampling ra
Sort:	Ascending							
Show:	<input checked="" type="checkbox"/>	<input checked="" type="checkbox"/>	<input checked="" type="checkbox"/>	<input checked="" type="checkbox"/>	<input checked="" type="checkbox"/>	<input checked="" type="checkbox"/>	<input checked="" type="checkbox"/>	<input checked="" type="checkbox"/>
Criteria:								"TMAD"
or:								

6. Splitting CO Data and Managing the CO Archive

After the timing of the CO data has been checked and any found errors corrected, the CO data is split into three sections:

Database	Table	Contents
CO1min.MDB	[CO1min]	Main CO database, all relevant and used, corrected CO data
CO1minTRASH.MDB	[CO1minCE]	Data from customer downloads, before and after the PEM case was with the customer
CO1minTRASH.MDB	[CO1min other]	Non-Expolis-Customer downloads, e.g. tests, pilots etc.

The database split is done by running the macro [Split whole database]. Select the Macro –tab from the database window. Then select the macro and double click it.

The splitting of customer data is based on the PEM sampling run times in the EADB as well as the CO data timing; thus these timings should be correct before running the database splitter. The table links to the three tables listed above should be checked to be properly set before running the database splitter. Step by step instructions:

1 check the table links in CO1minTOOL.MDB

Table link	Should point to database
[CO1min]	DATA\CO1min.MDB
[CO1minCE]	DATA\CO1minTRASH.MDB
[CO1min other]	DATA\CO1minTRASH.MDB

2 the data cleaning stages I and II described in previous chapter must be completed

3 run the [Split whole database] macro

4 continue with data cleaning stage III described in previous chapter

After splitting the database, CO data sections can be moved between the main and archive database with the CO Archive Manager (CAM) described in detail in the Appendixes.

6.1 [Split customers only] macro

The [Split whole database] macro splits both Expolis customer data and non-customers. All non customers are totally moved to the archive. Later, if some test measurements are specially wanted to be in the main database, the whole split cannot be run.

In case that some customer data is edited in time cleaning process, the [Split customers only] macro can be run to archive non-sampling range customer CO data. This macro will not touch any test or non-Expolis-customer data and thus it can be rerun when needed.

Non-Expolis-customer data archiving must be manually managed with CAM.

6.2 Discarding customer data

If a customer measurement is found to be erroneous and researchers decide to discard it, the customer's data should be moved to the CO1minTRASH.MDB archive file. This can be easiest done with CO Archive Manager, CAM. See the Appendix for detailed instructions.

7. Creating Final Static Tables after Data Cleaning

After data cleaning, the final static tables are created/updated with StaUp.

7.1 Calculating 15-Minute Averages

After the data is cleaned and splitted into archive and main data sections, the 15 minutes averages are calculated into the TMAD15min.MDB database using query [UpD CO 15min Table]. This query can be executed using StaUp.

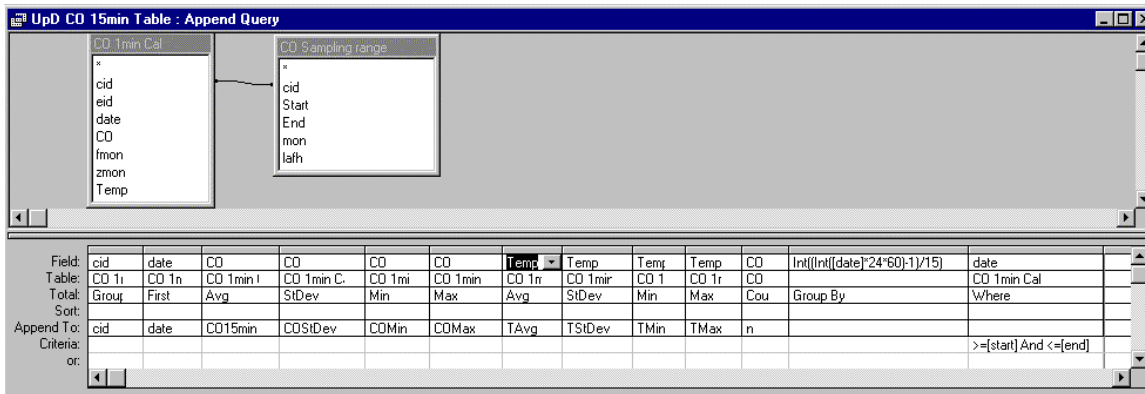

7.2 Creating 1-Minute Microenvironments

Also, for TMAD lines with only one check mark, 1-minute microenvironmental code is inserted in the [CO1min] table. For TMAD lines, where more than one microenvironment has been visited during the same 15 minutes, the 1-minute microenvironment codes are 102, 103 or 104. The code is 111 when there is more than 4 microenvironments during same 15 minutes period. These can be edited later manually. Return value of function *mEnv* in [CO module] is inserted into the field mEnv. When using StaUp, field *Target* must be NONE. This query is a real update query. It only updates corresponding field, other fields in [CO1min] stay untouched at this stage. Following table lists mEnv codes:

walk = 1	moto = 2	car = 3	bus = 4	train = 5	hi = 6
ho = 7	wi = 8	wo = 9	oi = 10	oo = 11	
two mE's = 102	three mE's = 103	four mE's = 104	more than 4 mE's = 111	missing mE = 0	

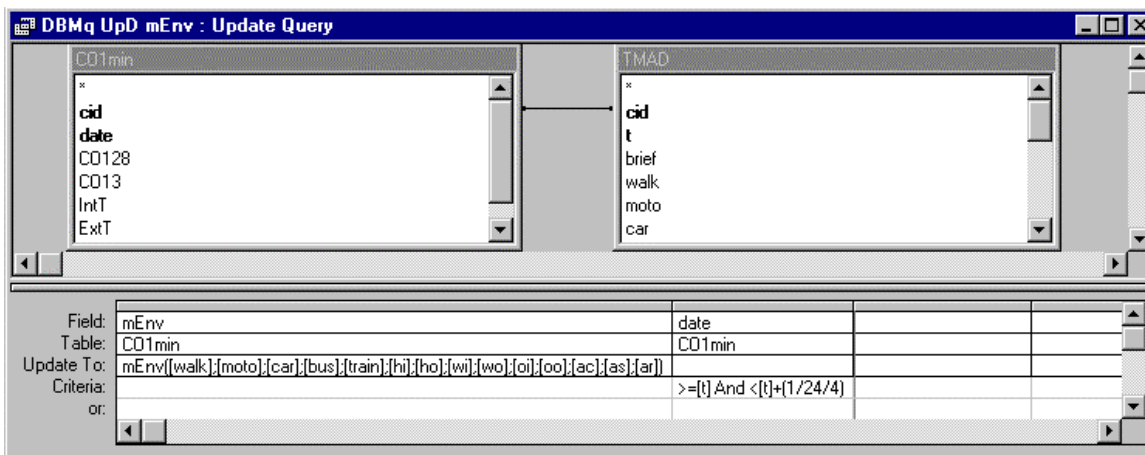

7.3 PEM Run average temperatures

The static table [CO Temp Avg] is used to store the Databear temperature averages for PEM filter sample sampling ranges. These are later used by the EADBTOOL.MDB to normalize the volumetric air sample into standard temperature and pressure. The pressure averages are taken from the FIXEDRUNS.MDB.

Table [CO Temp Avg] is updated by query [UpD CO Temp Avg table]

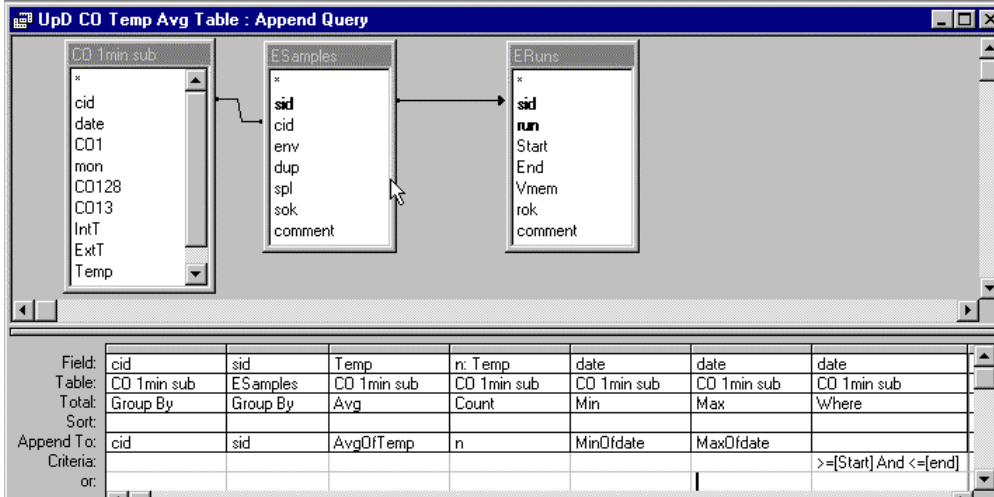

7.4 Creating other static tables

Next table lists some undocumented static tables in CO1min database.

Table:	Update query:	Description:
[TMAD CID t Env]	[UpD TMAD CID t Env table]	Used for TMAD/CO time comparison. [CO TMAD Tcal form] needs this table.
[TMAD Cust out]	[UpD TMAD Cust out table]	Used for TMAD/CO time comparison. [CO TMAD Tcal form] needs this table.
[DBMt CO cids all]	[DBMq Cids CO1min], [DBMq Cids CO1minTrashCE] and [DBMq Cids CO1minTrash Other]	Used for TMAD/CO time comparison. [CO TMAD Tcal form] needs this table. When updating run all these update queries.

CO1minTOOL-database contains form [CO TMAD Tcal]. This form can be used for comparing CO data to TMAD. CO temperatures are compared to time when customer has gone out according the TMAD.

TÄHÄN KUVA FORMISTA KUNHAN STATIC TABLEKSIT ON PÄIVITETTY

PART III: CO CONCENTRATION QUERIES

8. 1-Minute CO Concentration Calculation

This section describes all the queries used in the CQN to calculate calibrated CO concentrations. The downloaded CO values are calibrated using calibration and zero factors from the EADB. Then these calibrated ppm-readings are temperature corrected and converted to mg/m³ (in 20°C, 760 mmHg).

NOTE
Concentrations are in [mg/m³]

The calibration calculation uses monthly average of temperature corrected calibration factors. These are calculated from the CO calibration table in the EADB. It should be checked that the calibration terms for each Databear unit show a time variation suitable for using monthly averages.

The names of the queries are presented in brackets, following the Access convention. Each description includes the print of the query design view from Access. The top part of these prints lists the source tables/queries and the fields in these. The lower part lists the output fields, calculations and record selection criteria.

8.1 [CO Sampling range]

This query shows the sampling range for each customer from the [PEM Sampling ranges]. [PEM Sampling ranges] table is a static table, which must be updated in case data changes during the data cleaning. Closer instructions how to update static tables are in StaUp-instructions.

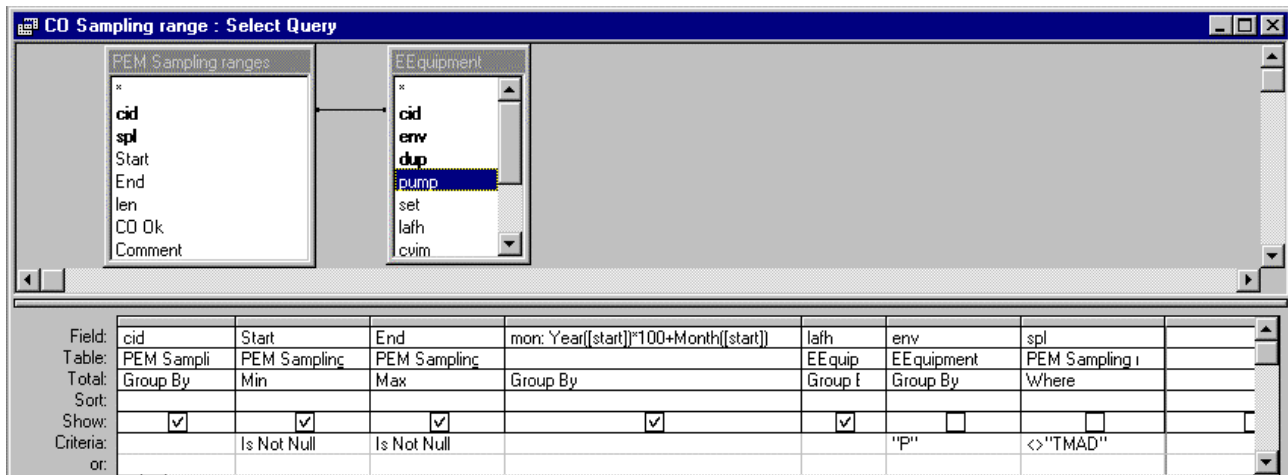

8.2 [Co cal]

This query calculates the calibration factors f for each calibration event in the EADB. Function CoTCor in [CO module] is used for calculating factor f. Tables [CO calibration gas bottles] and [CO calibrations] are linked from the EADB.

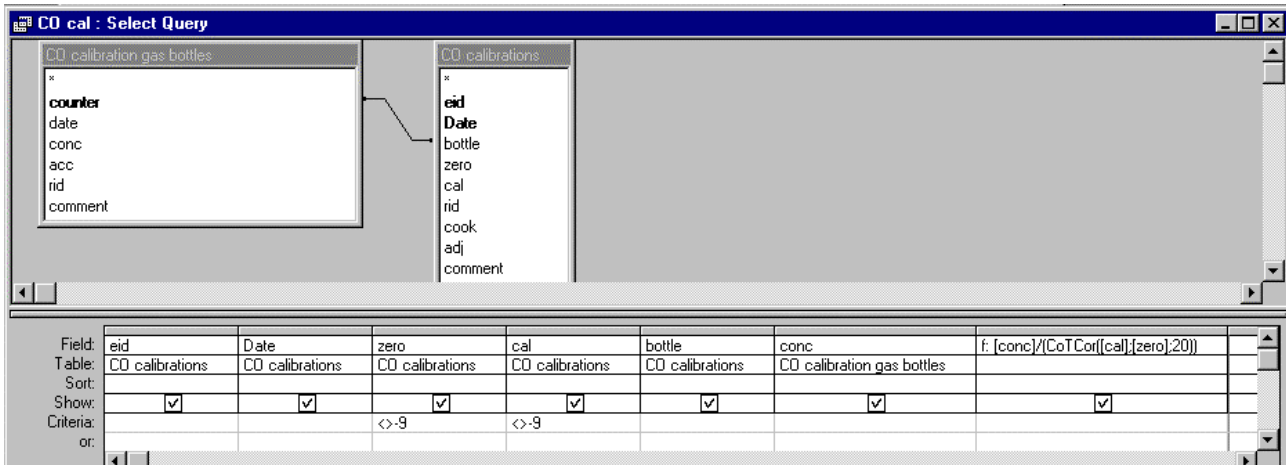

8.3 [CO Cal mon]

This query calculates the monthly averages for calibration factors f and zero.

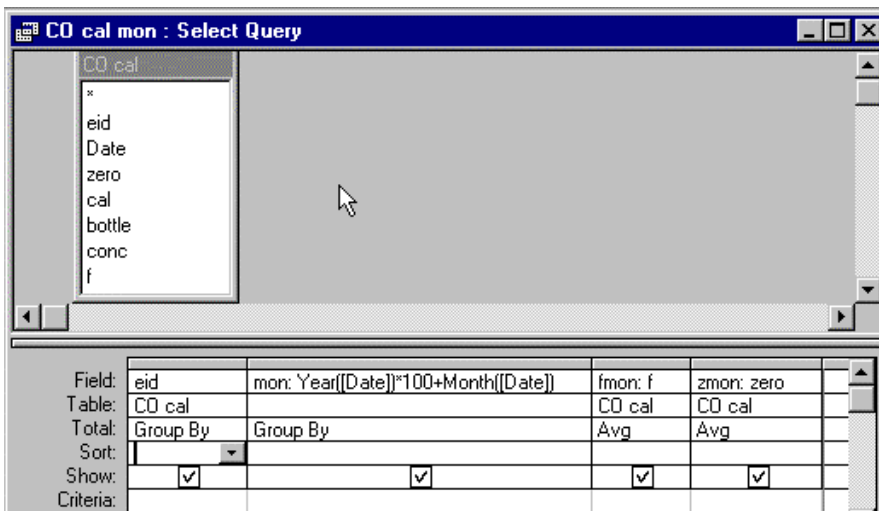

8.4 [CO 1min sub]

This query calculates the CO1 combined CO concentration, Temp combined temperature and selects the starting month of each customer sampling for linking to the [CO cal mon] query. [CO cid start end] is a static table, which must be updated if data changes during the data cleaning. [EEquipment] table is linked from EADB-database.

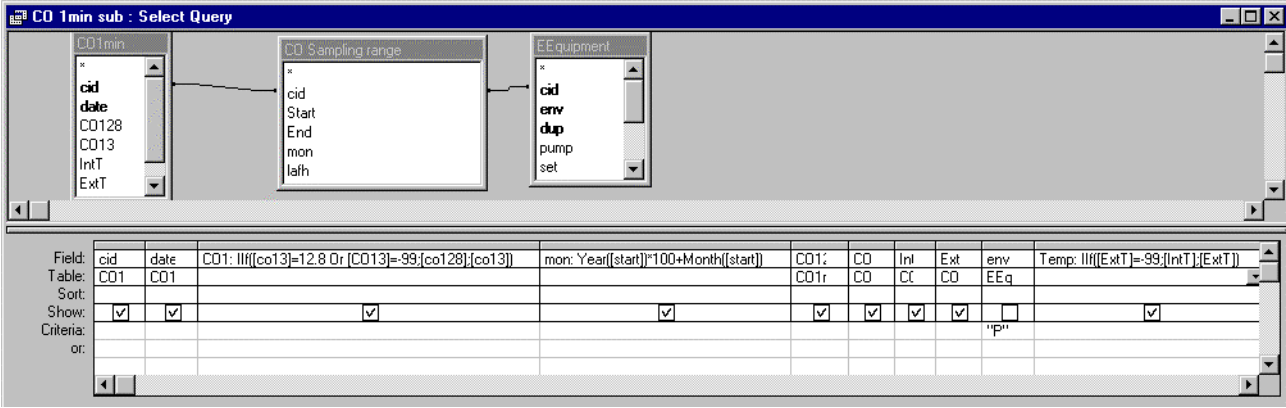

8.5 [CO 1min cal]

This query calculates the temperature corrected and calibrated CO 1 min concentration.

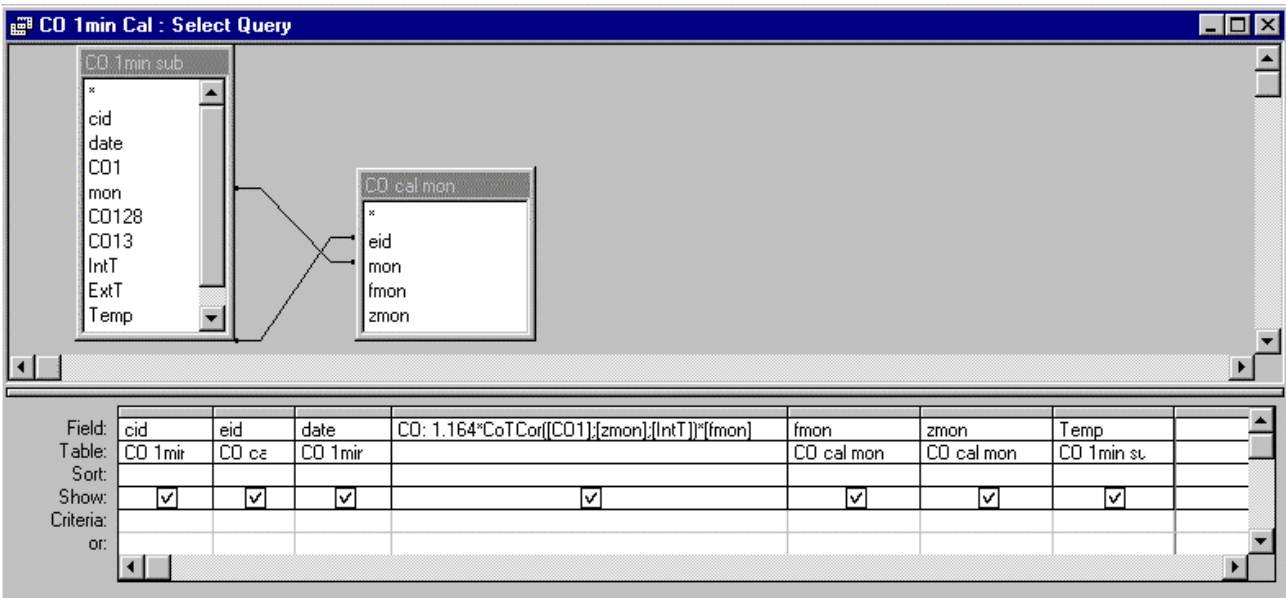

8.6 [UpD CO 15min Table]

This query calculates the 15 minutes average, standard deviation, minimum and maximum for CO and temperature. This query is an append query which appends results into the [CO 15 min] table. [CO15 min] table is a linked table which is located in TMAD15min.MDB database. Results of append query can be viewed without actual append by opening the query in design view and after that viewing query in datasheet view.

9. CO Concentration Aggregate Queries in the TMAD 15 minute database

These queries are used to create the EU report CO parameters from the 15 minute data. All of these queries are in the **TMAD15minTOOL.MDB** database.

Time label shown for each concentration is the end point of the corresponding averaging/measuring window.

9.1 [CO 15min customers]

This query selects the 15 min CO concentrations for exposure customers. More precisely the average time range is set to the EADB [CE Sampling range]. The output is created for only exposure customers from [CE Customer measurements].

Field:	Table:	Sort:	Show:	Criteria:
cid	CO 15min		<input checked="" type="checkbox"/>	
date	CO 15min		<input checked="" type="checkbox"/>	>[[minofstart]] And <=[maxofend]
n	CO 15min		<input checked="" type="checkbox"/>	>11
CO15min	CO 15min		<input checked="" type="checkbox"/>	

9.2 [CO48h]

This query calculates the 48 hour CO average for each customer. More precisely the average time range is set to the EADB [CE Sampling range]. The output is created for only exposure customers from [CE Customer measurements].

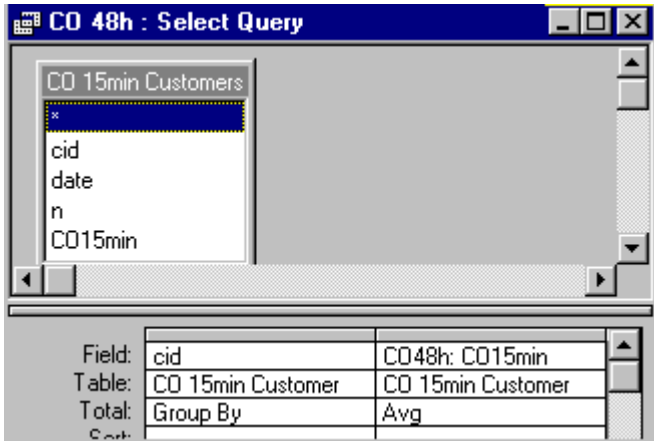

9.3 [CO 1h running] running 1 hour average calculation

This query calculates the 1 hour running CO average for each customer. More precisely the average time range is set to the EADB [CE Sampling range]. The output is created for only exposure customers from [CE Customer measurements].

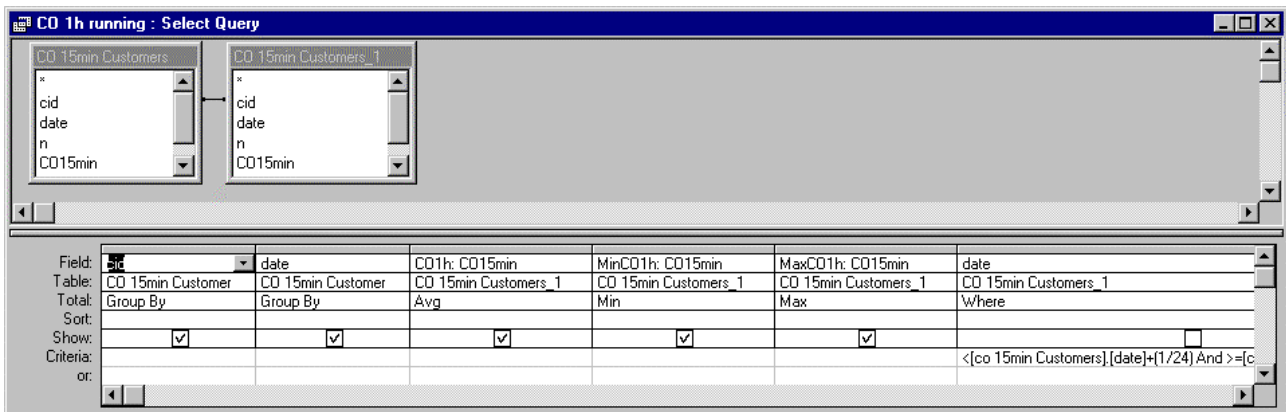

9.4 [CO 1h max] maximum running 1 hour average for each customer

This query calculates the highest running 1 hour concentration for each customer. This parameter is reported in the EU report.

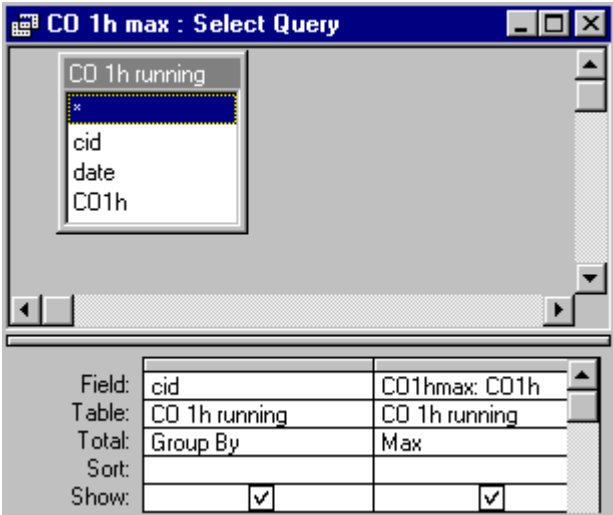

9.5 [CO 8h running] running 8 hour average calculation

This query calculates the 8 hour running CO average for each customer. More precisely the average time range is set to the EADB [CE Sampling range]. The output is created for only exposure customers from [CE Customer measurements].

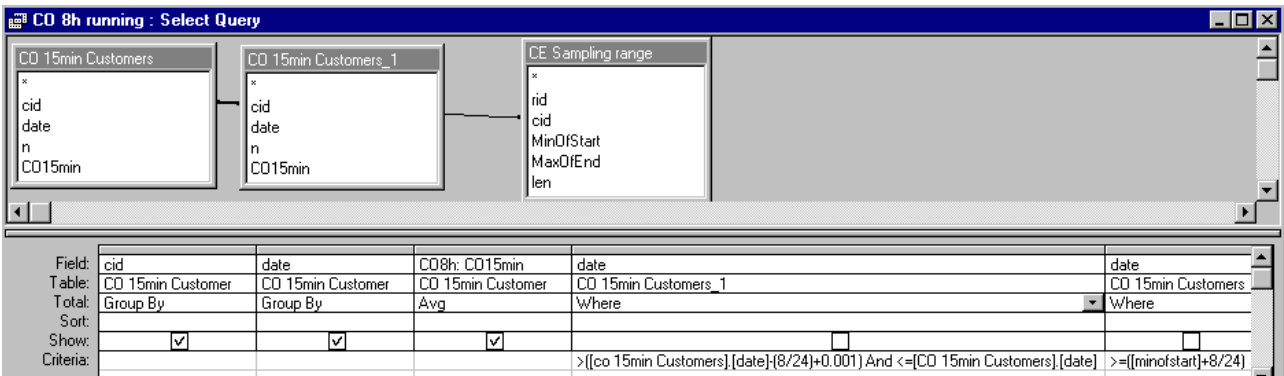

9.6 [CO 8h max] maximum running 8 hour average for each customer

This query calculates the highest running 1 hour concentration for each customer. This parameter is reported in the EU report.

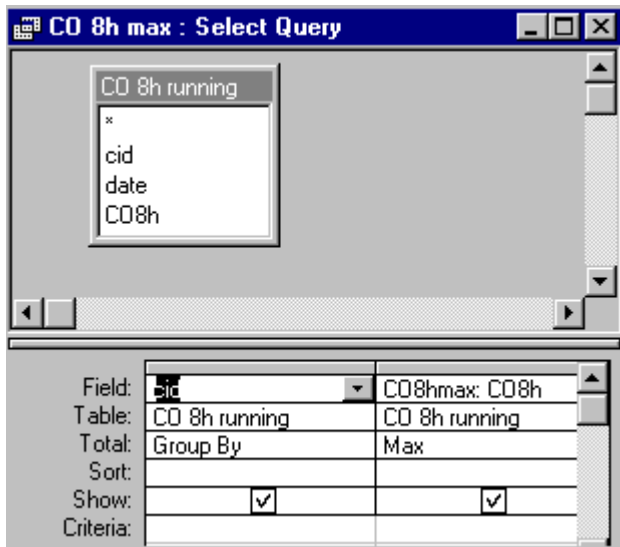

Appendixes

Appendix 1: CO Time Calibration

This form-based tool shows three views to customers' data

- 1 PEM sampling range from EADB
- 2 View to [CO time cor] table, where the Databear time correction factors are entered
- 3 View to Databear raw data

You can determine if the Databear clock was right looking at the temperature values when PEM sampling started and ended. If time mismatch exists, you can enter the value in minutes to the [CO time cor] table and run the correction to the CO data.

Appendix 2: CO Archive Manager (CAM)

After ensuring that a) all data is in and b) the Databear timing is correct, the CO data is divided into main data to be used later and two archive sections. These archive sections are

- 1 customer's non-PEM sampling range data (before and after the PEM case was with customer
- 2 non-Expolis-customer data (tests, microenvironmental measurements etc.

To view and move the data in these three tables a form based tool was developed. This tool is described in this appendix.

Appendix 3: Static Table Update system (STAUP)

The Expolis databases include many tables where the values are calculated from the primary raw measured values. Data in these static tables must be updated, if any of the source data changes in the data cleaning.

As some of the static table update queries are quite lengthy to run, a form based tool was developed to manage running multiple queries in a batch e.g. during the night time. This tool is called StaUp, and the structure of the tool is described in this appendix.

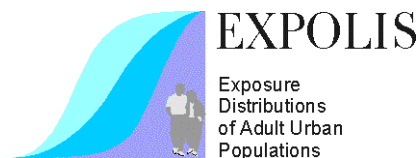

KTL ENVIRONMENTAL HEALTH

P.O.Box 95
FI-70701 KUOPIO
FINLAND

Otto Hänninen
Esa Kaarakainen
International tel. +358-17-201 171
International fax +358-17-201 265
E-mail/internet Otto.Hanninen@KTL.FI

kaarakai@hytti.uku.fi

EXPOLIS**CO Time calibration document**

Data Management

50 Pages

3. December 1998 / eKa

Subj. Technical documentation of CO Time calibration system in CO1minTOOL.MDB.

Ref.

CO Time calibration can be done by using [CO Time calibration]. This form displays PEM measurement time ranges for each customer, CO data for that selected customer and possible correction factor. Time correction can be done for selected customer. This document does not describe why the time correction should be done, it only describes how it can be done.

CO Time Calibration : Form

cid	sStart	sEnd	lafh
1	17.2.1997 8:40:00	19.2.1997 8:32:00	LD4
2	25.6.1997 8:27:00	27.6.1997 6:55:00	FD2

Record: 4 of 838

cid	Cor	rid	Comment	done	Changes
1	0	ff	sdfsdf	<input checked="" type="checkbox"/>	
*	0			<input type="checkbox"/>	

Correct current customer

cid	COdate	CO128	CO13	IntT	ExtT	mEnv
1	17.2.1997 8:33:00	1.5	1	14.7	11	
1	17.2.1997 8:34:00	1	0.9	14.7	12.5	
1	17.2.1997 8:35:00	1	0.8	14.5	13.5	
1	17.2.1997 8:36:00	1	0.8	14.5	14.5	
1	17.2.1997 8:37:00	1	0.9	14.5	14.5	
1	17.2.1997 8:38:00	1	0.9	14.5	15	
1	17.2.1997 8:39:00	1	0.9	14.5	15	
1	17.2.1997 8:40:00	1	0.9	14.5	15.5	
1	17.2.1997 8:41:00	1	0.8	14.5	15.5	
1	17.2.1997 8:42:00	1	0.8	14.7	16	
1	17.2.1997 8:43:00	1	0.8	14.7	16	
1	17.2.1997 8:44:00	1	0.8	14.7	16.5	
1	17.2.1997 8:45:00	1	0.8	14.7	16.5	
1	17.2.1997 8:46:00	1	0.8	15	17	
1	17.2.1997 8:47:00	1	0.8	15	17	
1	17.2.1997 8:48:00	1	0.8	15	17.5	
1	17.2.1997 8:49:00	1	0.8	15	17.5	
1	17.2.1997 8:50:00	1	0.8	15.3	18	

Record: 4782 of 7680

CO Time Calibration Graph : Form

Find Database data for Customer measurement start/end:

Start End

Current selection: Start

Record: 1 of 1

How to use [CO Time calibration] form

This form displays three subforms: Upper subform (grid) displays PEM measurement time ranges for all customers, lower subform displays CO data for selected customer (i.e. selected from upper grid) and middle grid displays time calibration information for selected customer. Short instructions:

1. Select whether you want to view measurement start or end time. Press corresponding button.
2. Select desired customer from upper grid. When record changes in upper grid, the lower grid will find same customer CO data for currently selected time.
3. Examine temperature values for start or end times and decide if you need to do time correction.
4. If needed enter calibration time correction in minutes to *Cor*-field in middle grid. Add also *comment* and your initials (field *rid*). Field *Done* is true if correction is already made. If you want to redo time calibration set *Done* -field to false. Possible calibration history is in field *Change*. Do not edit *Change* field, it is updated automatically.
5. Press "Correct current customer" to do time correction.

CO data can be viewed as graph by pressing hidden button between Start and End buttons. The graph needs anyway that Ms Graph 97 is installed. The CO data displayed by graph is approximately +/- 2 hours from selected time in [CO time calibration] form (i.e. upper grid, start or end).

Tables, queries, modules and forms needed for CO Time calibration

CO time correction needs following database objects:

- [CO Time Calibration] form,
- [CO Time Calibration sub1] form,
- [CO Time Calibration sub2] form,
- [CO Time Calibration sub3] form,
- [CO Time Calibration Graph] form,
- [CO Time cor] table,
- [CO sampling range] query and
- [DBMmo Procs] module

[CO Time calibration] form

This is the main form that displays all subforms as table view. Time correction can be done by pressing corresponding button. Time correction procedure creates a recordset which contains currently selected customer's all records in [CO1min] table. The order of recordset depends on whether the correction cor is negative or positive. New time will be updated to all records in that recordset one by one and the update procedure is done using VisualBasic function not a SQL-update clause. That is why the procedure may be long lasting. After the update *Done*- and *Changes*-fields in [CO Time cor] table will be updated.

Subforms are linked to hidden text box: CidBox.

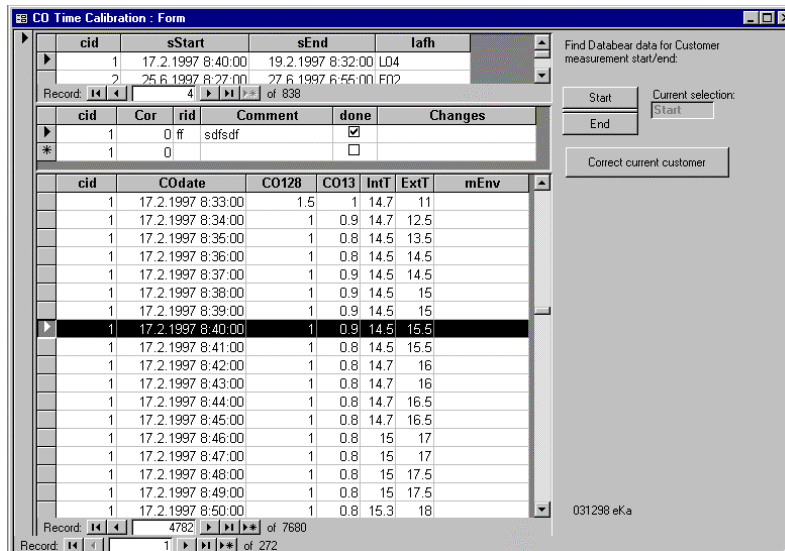

[CO Time calibration sub1] form

This form displays CO data for current customer from [CO1min] table.

[CO Time calibration sub2] form

This form displays results of [CO sampling ranges] query. When user selects (changes a record) from this form, corresponding time (start or end) is find into the [CO Time Correction sub1] form.

[CO Time calibration sub3] form

This form displays records from [CO time cor] table for selected customer.

[CO Time calibration Graph] form

This form displays +/- 2 hours CO data for PEM sampling range start or end time of currently selected customer. The graph on form is MsGraph 97 object and it probably needs MsGraph 97. This is not tested on such computer that does have earlier version of MsGraph. MsGraph can be installed with Microsoft Office 97.

A SQL-select clause which selects needed records from CO1min-table, is created after the graph-button is pressed. That SQL-string will be set for graph's data source.

[CO Time cor] table

This table contains information about possible time corrections.

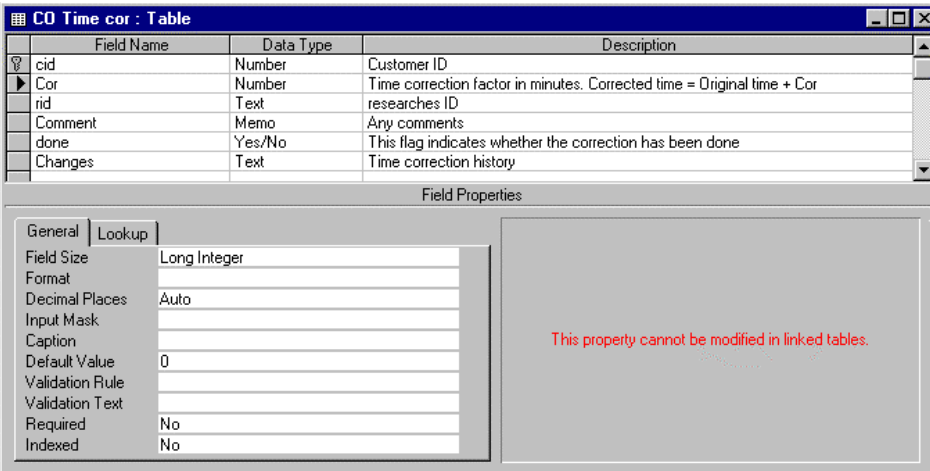

Field Name	Data Type	Description
cid	Number	Customer ID
Cor	Number	Time correction factor in minutes. Corrected time = Original time + Cor
rid	Text	researches ID
Comment	Memo	Any comments
done	Yes/No	This flag indicates whether the correction has been done
Changes	Text	Time correction history

Field Properties	
Field Size	Long Integer
Format	
Decimal Places	Auto
Input Mask	
Caption	
Default Value	0
Validation Rule	
Validation Text	
Required	No
Indexed	No

This property cannot be modified in linked tables.

Fields *done* and *Changes* are updated automatically if Time correction procedure succeeds. *Done* field is set to True and time correction factor is added to *Changes*-string. *Changes* field can be used to backtrack previous corrections. Do not edit *Changes*-field, otherwise you may loose whole history on what time correction has been done.

[CO sampling range] query

This query gets PEM sampling ranges for all customers. Query is described in CO User's manual.

[DBMq Procs] module

CO Time calibration –procedure needs some functions e.g. *DateToSqlDate* from this module.

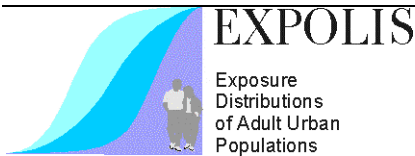

KTL ENVIRONMENTAL HEALTH

P.O.Box 95
FI-70701 KUOPIO
FINLAND

Otto Hänninen
Esa Kaarakainen
International tel. +358-17-201 171
International fax +358-17-201 265
E-mail/internet Otto.Hanninen@KTL.FI

kaarakai@hytti.uku.fi

EXPOLIS**CO1min Archive Manager Instructions**

Data Management

50 Pages

8. December 1998 / eKa

Subj. Documentation of CAM, Co1min Archive Manager system.

Ref.

This booklet describes how to use CO 1 minute archive manager. This is also a brief documentation about the needed tables, queries, forms and modules.

What is CAM

Expolis CO data is stored in three tables: *[CO1min]* and *[CO1minTrash CE]* and *[CO1minTrash Other]*. *[CO1min]* table contains only Expolis customers measured data, customers CO data that is not on measurement time range is in *[Co1minTrash CE]* table. Other CO data (i.e. non-Expolis customers, samples, duplicates...) is stored in *[CO1minTrash Other]* table. CAM form is created for moving data between these three tables.

Using [CAM] form (i.e. CAMming)

- 1 Open Access
- 2 Log on as ladmin (You need to have rights to delete data).
- 3 Make sure that table *[DBMt CO cids all]* has been updated. Use StaUp system to update that tables if needed.

NOTE: CAM does not display all cids if the table *[DBMt CO cids all]* is not updated.

- 4 Open *[CAM]* form

cid	date	co128	CO13	IntT	ExtT	mEnv
1	15.2.1997 18:10:00	2.5	2	18.6	20.5	
1	15.2.1997 18:11:00	2.5	2	18.6	20.5	
1	15.2.1997 18:12:00	2.5	2	18.6	20.5	
1	15.2.1997 18:13:00	2.5	2	18.6	20.5	
1	15.2.1997 18:14:00	2.5	1.9	18.6	20.5	
1	15.2.1997 18:15:00	2	1.9	18.6	20.5	
1	15.2.1997 18:16:00	2	1.9	18.6	20.5	
1	15.2.1997 18:17:00	2	1.9	18.6	20.5	
1	15.2.1997 18:18:00	2	1.9	18.6	20.5	
1	15.2.1997 18:19:00	2	1.9	18.6	20.5	
1	15.2.1997 18:20:00	2	1.9	18.6	20.5	
1	15.2.1997 18:21:00	2	1.8	18.6	20.5	
1	15.2.1997 18:22:00	2	1.8	18.6	20.5	

- 5 Select search conditions. You can search for certain customer using cid and date limits.

- 6 Press Search button

- 7 Select table from which you want to move records.
- 8 Press Cut-button to mark all records in current table.
- 9 Select table into which you want to move records and press Paste -button. The pasting process starts. The process may take a while if number of selected records is great.

NOTE: Cut and paste procedures in CAM do not use Windows clipboard to move records. Paste is done record by record and that is why it may be a bit long lasting.

NOTE: By pressing Ctrl+Break you can stop the Paste process. In that case the cursors stays as hourglass. You can change cursor back to normal by doing the CAM for empty recordset. (Anyway, it is a feature, not a bug:).

NOTE: With *Undo*-button you can unselect current selection, but you can not undo the paste. If you are unsure what you are doing or something went wrong, make sure you remember search conditions so you can do reverse CAM.

Tables, modules and forms needed for CAM

Co1min Archive Manager needs following database objects:

- [CAM] form,
- [CAM sub CO1min] form,
- [DBMmo Procs] module,
- [DBMt CO cids all] table,
- [DBMq Cids CO1min] query,
- [DBMq Cids CO1minTrash CE] query and
- [DBMq Cids CO1minTrash Other] query.

[CAM] form and [CAM sub CO1min] form

This is the main form of CAM. Form contain one subform, [CAM sub CO1min]. This subform displays those records, which apply to search conditions from currently selected table. Most of the functions and procedures are in form's own module.

When *Search*-button is pressed, three recordsets (one for each table: [CO1min], [CO1min Trash CE] and [CO1min Trash Others]) will be created according the search conditions (cid, star date and end date).

Table selection buttons change the record source property of [CAM sub CO1min] form.

Cut-button marks the current record set and *Paste*-button pastes the selected record set into current table. *Undo*-button unmark the selected recordset. After *Paste*-button is pressed there is no option to undo.

[DBMmo Procs] module

This module contains some common functions which are used by many forms. CAM uses at least function *DateToSqlDate* from this module.

[DBMt CO cids all] table

This table contains all customer IDs, cid's, in tables [CO1min], [CO1min Trash CE] and [CO1min Trash Others]. This table must be updated by using following queries before you use CAM. This table is source table of [CAM] form. Use *StaUp* to update this table: select all queries whose target is this table.

[DBMq Cids CO1minTrash Other] query

This query finds all cids from [CO1minTrash Other] table and inserts them into the static table [DBMt CO cids all].

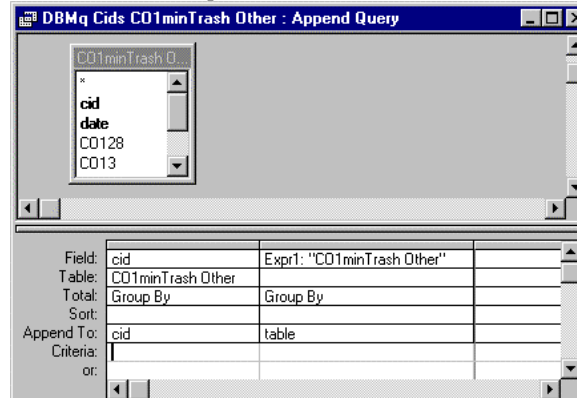

[DBMq Cids CO1minTrash CE] query

This query finds all cids from [CO1minTrash CE] table and inserts them into the static table [DBMt CO cids all].

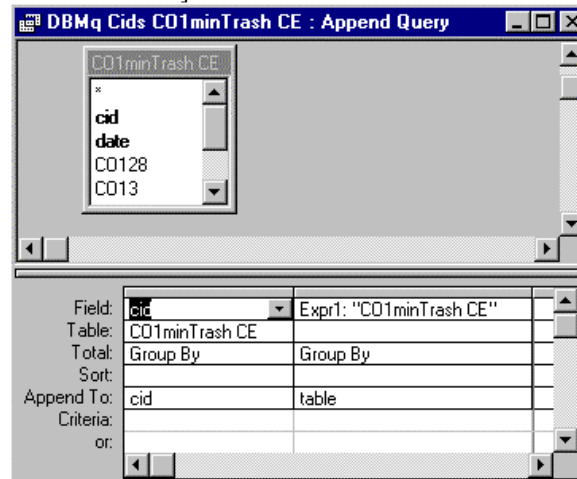

[DBMq Cids CO1min] query

This query finds all cids from [CO1min] table and inserts them into the static table [DBMt CO cids all].

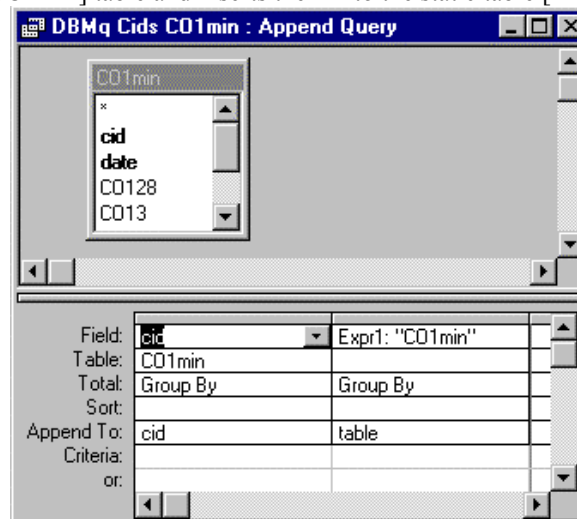

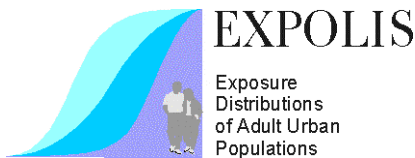

KTL ENVIRONMENTAL HEALTH

P.O.Box 95
FI-70701 KUOPIO
FINLAND

Otto Hänninen
Esa Kaarakainen
International tel. +358-17-201 171
International fax +358-17-201 265
E-mail/internet Otto.Hanninen@KTL.FI
kaarakai@hytti.uku.fi

EXPOLIS

Data Management

StaUp system documentation

50 Pages

7. December 1998 / eKa

Subj. Documentation of StaUp, Static Table Update system, version 301198.

Ref.

This booklet describes what are static tables and how to update them. This is also documentation about the needed tables, queries, forms and modules.

What are *Static tables*?

The term “Static table” means normal Access table which is created from original raw data tables using append or make-table queries. Static tables are created for various purposes, e.g. they may contain some calculated data or they are created for speeding up the execution time of queries.

Basically the use of the static tables is against the principles of Expolis database management where is said that all data is stored in its raw format and the concentrations and other calculations are done by using dynamic queries. But the data amounts are so large that in some cases we must use static tables. For instance the running times of some queries decreases markedly when some sub-queries are changed to tables.

Static tables must be updated if the original data changes, e.g. during the data cleaning process. The update can be done by using [*Static table update form*] -form. You can select the queries you want and run them all at same time. If queries are long lasting you can run them at night. The form automatically executes each selected query and it does not ask any confirmations or show error messages. In case of an error the error message will be written into the [*DBMf Static queries*] -table, execution of the current query will fail and next query will be executed.

Using [*Static table update form*]

- 1 Open Access
- 2 Log on as ladmin (You need to have rights to delete data).
- 3 Open database which contains [*Update Static tables*] form (eg. CO1minTOOL.MDB). using *File/Open database...* -dialog.

NOTE: This way MsAccess changes the default directory to the directory where the database file is. Do not open database any other way (e.g. double-clicking the icon of database file in Windows Explorer or using the recent file list). Some update queries assume to find other database files from same directory as current database. When the default directory is something else, the execution of those queries will fail.

4 Open [Static table update form] form

Update	Target table	Source table	Updating query	Date of last run	Suc	Duration
<input checked="" type="checkbox"/>	CO 15min	CO1min	UpD CO 15min table	30.11.1998 14:54:41	<input checked="" type="checkbox"/>	0:30:51
<input type="checkbox"/>	CO cid start end	CO1min	UpD CO cid start end Table	25.11.1998 8:14:32	<input checked="" type="checkbox"/>	0:03:16
<input type="checkbox"/>	CO Temp Avg	CO1min	UpD CO Temp Avg Table	1.10.1998 17:17:41	<input checked="" type="checkbox"/>	0:39:32
<input type="checkbox"/>	CO Temp Avg	Eruns	UpD CO Temp Avg Table	1.10.1998 17:17:41	<input checked="" type="checkbox"/>	0:39:32
<input type="checkbox"/>	CO Temp Avg	Esamples	UpD CO Temp Avg Table	1.10.1998 17:17:41	<input checked="" type="checkbox"/>	0:39:32
<input type="checkbox"/>	DBMt CO cids all	CO1min	DBMq Cids CO1min	6.11.1998 13:25:43	<input checked="" type="checkbox"/>	0:00:36
<input type="checkbox"/>	DBMt CO cids all	CO1minTrash CE	DBMq Cids CO1minTrash CE	6.11.1998 13:25:06	<input checked="" type="checkbox"/>	0:00:31
<input type="checkbox"/>	DBMt CO cids all	CO1minTrash Other	DBMq Cids CO1minTrash Other	6.11.1998 13:24:33	<input checked="" type="checkbox"/>	0:00:18
<input type="checkbox"/>	DC CO Peaks	CO1min	UpD DC CO Peaks Table	17.11.1998 17:22:37	<input checked="" type="checkbox"/>	0:06:27
<input type="checkbox"/>	NONE	NONE	CE Stat CO	25.11.1998 8:28:05	<input checked="" type="checkbox"/>	0:06:31
<input type="checkbox"/>	NONE	NONE	CE Stat T	25.11.1998 8:21:30	<input checked="" type="checkbox"/>	0:06:32
<input type="checkbox"/>	NONE	TMAD	DBMq UpD mEnv	14.10.1998 19:23:41	<input checked="" type="checkbox"/>	2:35:34
<input type="checkbox"/>	PEM Sampling ranges	CO1min	UpD PEM SR CE	25.11.1998 8:14:46	<input checked="" type="checkbox"/>	0:00:06
<input type="checkbox"/>	PEM Sampling ranges	CO1min	UpD PEM SR TMAD	25.11.1998 8:14:39	<input checked="" type="checkbox"/>	0:00:04
<input type="checkbox"/>	PEM Sampling ranges	Eruns	UpD PEM SR CE	25.11.1998 8:14:46	<input checked="" type="checkbox"/>	0:00:06
<input type="checkbox"/>	PEM Sampling ranges	Eruns	UpD PEM SR TMAD	25.11.1998 8:14:39	<input checked="" type="checkbox"/>	0:00:04
<input type="checkbox"/>	PEM Sampling ranges	Esamples	UpD PEM SR CE	25.11.1998 8:14:46	<input checked="" type="checkbox"/>	0:00:06
<input type="checkbox"/>	PEM Sampling ranges	Esamples	UpD PEM SR TMAD	25.11.1998 8:14:39	<input checked="" type="checkbox"/>	0:00:04
<input type="checkbox"/>	TMAD Cid t Env	TMAD	UpD TMAD Cid t Env Table	2.10.1998 11:59:46	<input checked="" type="checkbox"/>	0:04:24
<input type="checkbox"/>	TMAD Cust out	TMAD	UpD TMAD Cust out Table	2.10.1998 12:26:26	<input checked="" type="checkbox"/>	0:26:36

Fields of the form:

- Update = select this to delete data from target table and execute append query
- Target table = name of the target table which will be updated
- Source table = name of the source table from which the data will be get
- Append query = name of the query which appends data into the target table
- Last run = time when the append query was last run
- Suc = was the last run successful
- Length of run = length of last run

5 Select the rows on which the source table data has changed and press Update-button to start the process.

You can select which tables you want to update. If Update-checkbox is checked and Update-button is pressed, contents of target table will be deleted and selected query/queries will be executed so that new data will be inserted into the target table.

NOTE: You can run also normal select-queries with StaUp. Insert new record into [DBMt Static tables] –table in which field *Target* is “NONE” and if needed *Source* –field may also be “NONE”. Field *Query* contains the name of the query you wish to run. Make sure that field *Source* is none, otherwise all data in that table will be lost.

This form automatically selects all rows on which the target table is same as you checked. This is done because at first all records from the target table will be deleted and after that new data will be inserted into the target table. All queries that insert data into the target table must be executed.

NOTE: If the previous run was unsuccessful (*Suc* is not checked) it is possible that target table does not contain any data at all. [DBMt Static queries] table contain information about the queries executed. Field *ErrDsc* contains error description if

the run was unsuccessful. Find the reason why query was not executed, fix the error and run the update query again.

NOTE: Duration field may display peculiar values. Reason for this might be the Regional Settings of your computer. The form was designed using Finnish settings. At least with English (US) settings duration field did not display values right.

Tables, modules and forms needed for updating static tables

Automatic static table updating needs following database objects:

- [Static table Update form] form,
- [DBMmo Procs] module,
- [StaUp Procs] module,
- [DBMt Static tables] table,
- [DBMt Static queries] table,
- [DBMq StaUp table update] query and
- [DBMq StaUp table update sub] query

[Static table update form] form

This form is used for selecting the update queries to run. Form uses several functions and procedures from modules [StaUp Procs] and [DBMmo Procs]. There are also some functions and procedures in form's own module. Form displays contents of [DBMt Static tables] table.

Fields *Target table*, *Source table* and *Updating query* are straight from [DBMt Static tables] table. Fields *Date of last run*, *Suc* and *Duration* are updated each time the form is opened or Update-button is pressed.

After the update button is pressed three main tasks are executed:

1 Delete all data from selected target tables

- all selected target tables will be deleted before any append queries are executed
- if the user does not have rights to delete data an error message will be displayed and the updating process stops, this error should never exist because only the administrators have rights to open and run this form

2 Execute selected append queries

- all selected append queries will be executed
- queries will be grouped by the name so that each query will be executed only once
- order of the queries depends of the priority (Qprio -field in [DBMt Static tables] table)

3 For each append query information about the run will be written into the [DBMt Static queries] table.

[StaUp procs] module

This module contains functions and procedures needed in StaUp system. Each function and procedure have comments which (should) tells what is the purpose of it.

[DBMmo Procs] module

This module contains several database management functions and procedures. Many forms or queries use functions and procedures in this module.

If this module is changed, it must be copied into all databases that contain this module. Database list is in the declarations part of the module.

[DBMt Static tables] table

This table contains information about the static tables and queries that append data into static tables. All table and query names must right spelled otherwise the automatic update fails.

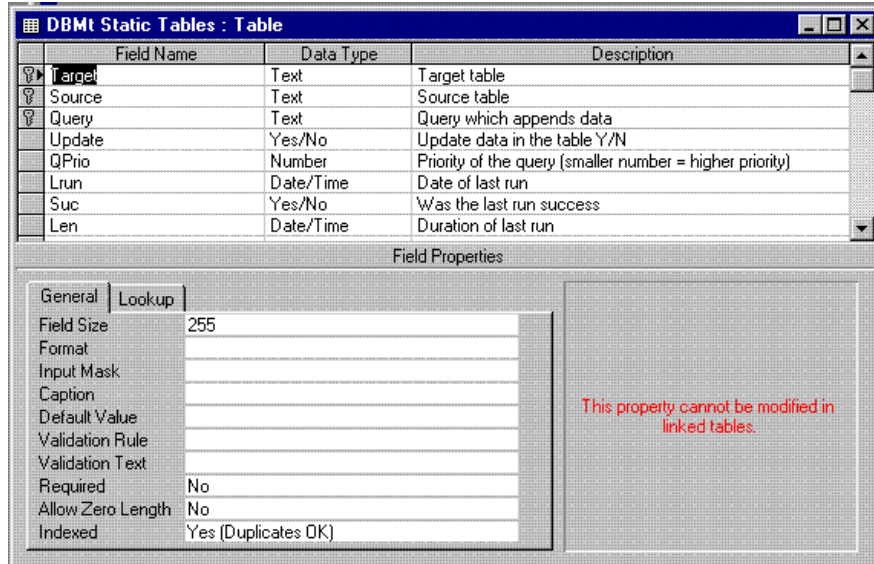

Same query name may be in this table many times depending on how many source tables it uses. Qprio (priority of the query) must be exactly same for each row where the query name is same. Field *Qprio* tells in which order queries must be and execution order.

Fields *Lrun*, *Suc* and *Len* contain last run information of each query. These fields are updated automatically each time the StaUp form is opened or the update is done. [DBMt StaUp table update] query updates these fields.

[DBMt Static queries] table

This table contains information about the runs of the append queries. Table works as a log, it is updated each time any of the append queries is executed from the [DBMf Update static tables] form. Each line contains query name, time when it was executed, suc is true if execution was successful, length of run and possible error message.

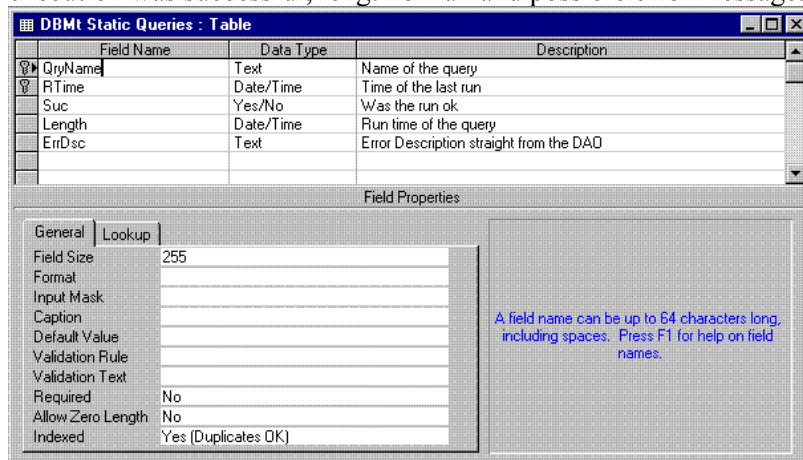

ErrDsc is the error message that MsAccess creates if an error occurs during the update. The error message will not be displayed on screen, it will only be written into this field. Closer

description about current error can be found from MsAccess help topics using keywords trappable errors or under topic Error object -> Number property -> Trappable Data Access Errors.

[DBMq StaUp table update] query

This query updates last run information into the [DBMt static tables] table.

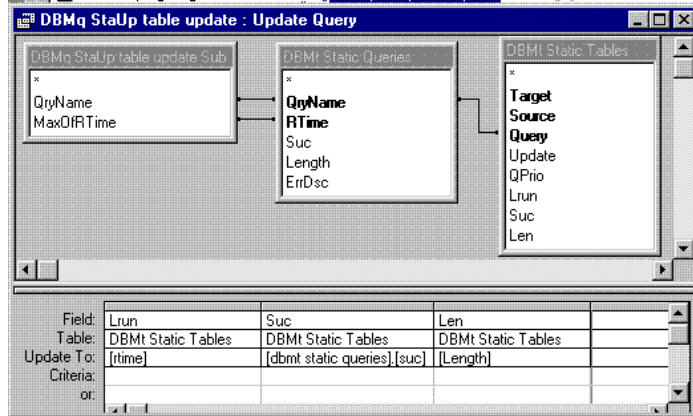

[DBMq StaUp table update Sub] query

This sub-query is used for getting the last run time for each query in [DBMt Static queries] table. The reason why there is two queries for updating last run information is that you can not use *Totals* in update-query.

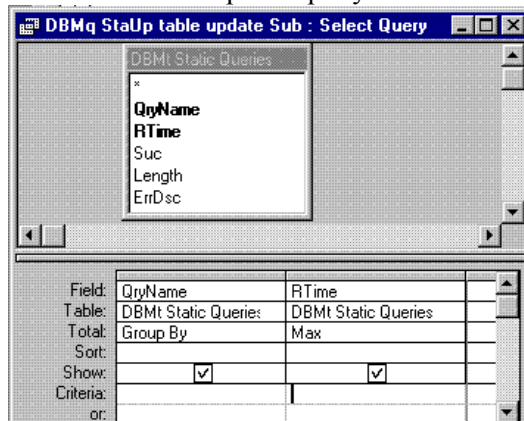

Documentation of the
Concentration Query Network:
AMBIENT

Version 1b (not released) 24.6.1999

Database files

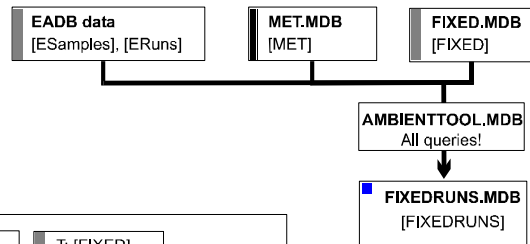

Data cleaning

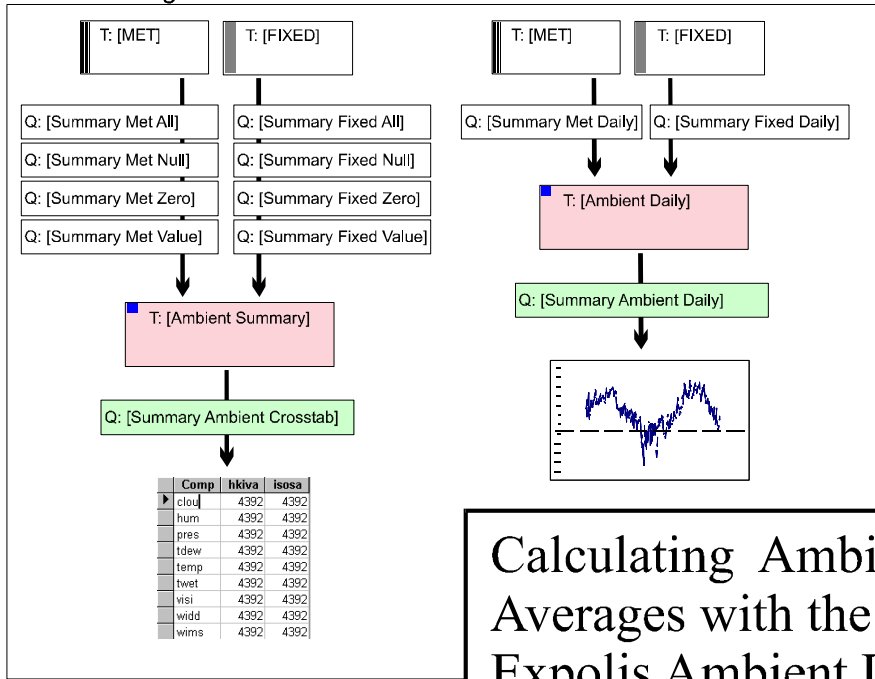

Calculating Ambient Averages with the Expolis Ambient Database

Expolis sample run averages

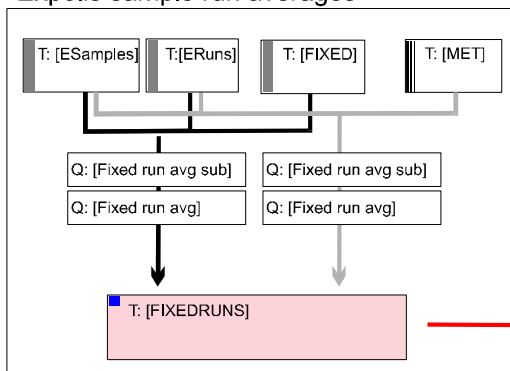

Distances and Ambient concentrations

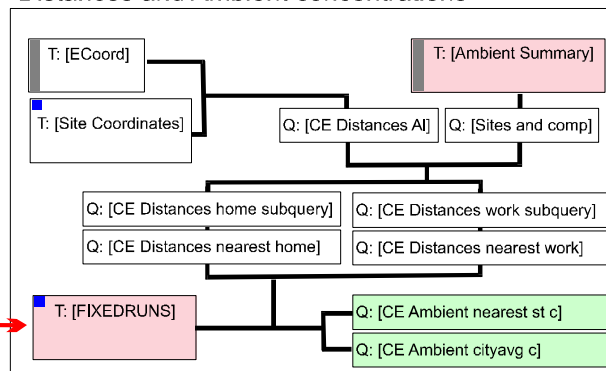

Expolis
KTL Environmental Health
P.O.Box 95
FI-70701 KUOPIO
FINLAND

Otto Hänninen
Email OTTO.HANNINEN@KTL.FI
Tel +358-17-201 171
GSM +358-400-673 207
Fax +358-17-201 265

Juha Keski-Karhu
JUHA.KESKI-KARHU@KTL.FI
+358-17-201 347

Esa Kaarakainen
KAARAKAI@HYTTILUKU.FI
+358-17-201 347

Contents

1.	INTRODUCTION	3
2.	THE STRUCTURE OF THE EXPOLIS AMBIENT DATABASE	4
2.1.	Key variables	4
2.2.	Static versus dynamic data	5
2.3.	Action Queries	5
2.3.1.	Append queries	5
2.3.2.	Delete queries	5
2.4.	Static Table Update System “StaUp”	6
3.	MET, FIXED, FIXEDRUNS AND AMBIENTTOOL DATABASES	8
3.1.	Installing the Expolis Ambient Database	8
3.2.	Tables in the FIXED.MDB database	8
3.3.	Tables in the MET.MDB database	10
3.4.	Tables in the FIXEDRUNS.mdb database	11
3.5.	AMBIENTTOOL.MDB database	13
4.	IMPORTING MET AND FIXED DATA INTO ACCESS	14
4.1.	Importing data from Excel or other primary data format	14
4.2.	Combining date and time fields with [Dateserial]	14
4.3.	[DC Normalize], Normalization of the imported data tables	15
5.	STAUP IN AMBIENTTOOL	17
6.	DATA CLEANING	18
6.1.	[Summary Fixed ‘type’] and [Summary Met ‘type’] queries	18
6.2.	Time series: [Summary Fixed daily], [Summary Met daily]	19
6.3.	[DC Fixed datelimits], [DC Met datelimits]	20
6.4.	[DC Deletenulls]	20
6.5.	[DC Fixed statistics], [DC Met statistics]	21
7.	CREATING FIXEDRUNS.MDB DATABASE	22
8.	NEAREST STATION CONCENTRATIONS	24
8.1.	Distance queries	24
8.1.1.	[CE Distances all]	24
8.1.2.	[CE Distances home subquery]	25
8.1.3.	[CE Distances nearest home]	25
8.1.4.	[CE Distances work subquery]	25
8.1.5.	[CE Distances nearest work]	26
8.1.6.	[Sites and comp]	26
8.1.7.	ExpolisCoords, module	27
8.2.	Ambient air queries	28
8.2.1.	[CE Ambient nearest st c]	28
8.2.2.	[CE Ambient cityavg c]	28
8.2.3.	[CE Ambient bgstation c]	29

1. Introduction

Expolis measurements of personal exposures and microenvironmental concentrations were done in six European cities during 1996-1997. Corresponding ambient air quality data and meteorological conditions in each city are stored in Expolis ambient database, which is described in this document.

After the importing all the met and fixed data into the ambient database, they are checked and all errors are corrected or removed. This is called the data cleaning.

After the data cleaning, averages of ambient variables are calculated for the Expolis sample sampling runs and these are stored in a separate database file called FIXEDRUNS.MDB.

14.10.1998 Kuopio

Otto Hänninen
Juha Keski-Karhu

2. The structure of the Expolis Ambient Database

The Expolis Ambient Database consists of three data database files and one tool database file:

DATA FILES	Explanation
- FIXED.MDB	Hourly ambient air quality monitoring results
- MET.MDB	3-hourly meteorological observations
- FIXEDRUNS.MDB	Expolis sampling run averages of above data

TOOL FILE	Explanation
- AMBIENTTOOL.MDB	Tool database to process data in above 3 data databases

Schematic diagram of the data files is shown in the figure below.

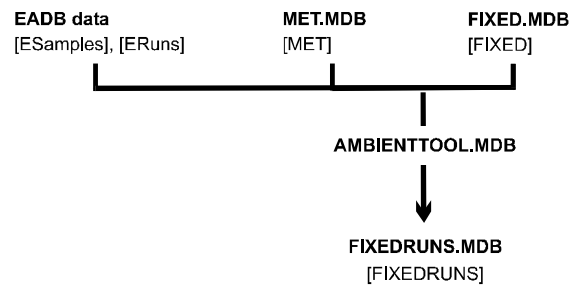

Figure 1. Basic structure of the Expolis Ambient database.

2.1. Key variables

The key variables used in the ambient database are presented in the table below.

Variable	Explanation	FIXED	MET
Date	Date and time of measurement	value is 1-hour average, date showing the start time of the averaging period	value is measured in 3-hour interval, date showing the local time of measurement
Site	Name of the measurement station	(5 characters)	(8 characters)
Component	Quantity measured (5 chars)	e.g. NO ₂ , CO, SO ₂ etc.	e.g. wims, widd etc
Value	Value of the measurement		
Sitename	Full name of the station.		
N	Northern coordinate [m] of the measurement station		
E	Eastern coordinate [m]		

Note that the coordinates N and E must be presented using a local rectangular coordinate system.

The coordinates of customers' homes and workplaces must be presented using the same system. Distances between the stations and homes and workplaces are calculated using Euclidian distances.

2.2. Static versus dynamic data

Earlier in the Expolis Access Database (EADB) system only the raw data items were stored in tables. All calculated values were dynamically calculated from these data tables. This system ensures that

- all calculation are performed in the same way (that is, correctly)
- all corrections to the data entry are reflected to all values calculated from the database

Now with the CO and ambient data some data tables in the Expolis database grow so big that computer performance becomes a limiting factor and the dynamic calculate-always-from-raw-data-items –approach is not practical. In these cases the calculated values must be stored in a result table in the database. As the values in these tables are stored and do not change when the source data are edited, the tables are called *static*.

NOTE: new type of tables is introduced to the Expolis database system

Calculated values are stored in tables for computer performance reasons. These tables are called *Static*.

A special Static Table Update System was developed for updating and managing the data in these static tables. User's of the database should be aware, that data in these tables do not reflect the latest corrections to the basic measurement data.



2.3. Action Queries

Earlier in the Expolis Access Database (EADB) system, only select queries have been used. Select queries select records from one or more tables and show them on the screen.

Now the CO and Ambient databases add new query types – action queries - to the user interface of the Expolis databases.

Instead of just viewing the result, action queries perform a spesific tasks:

- | | |
|---|----------------|
| - append new records to an existing table | APPEND QUERIES |
| - delete records from a table | DELETE QUERIES |
| - calculate new values into fields in a table | UPDATE QUERIES |

These queries are run by pressing the  button. The result can be viewed, without performing the task, by pressing the datasheet view button, .

Types of action queries used in AmbientTOOL are following:

2.3.1. Append queries

Append queries automatically add records to a specified table.

In the Expolis databases append queries are used to construct nondynamically calculated data tables, static tables. Static tables updating system can be used to update static tables if any changes in source tables arise.

2.3.2. Delete queries

Delete are used to delete selected records from specified tables.

WARNING. You must not experiment with delete queries, because they delete records permanently. It is recommended that you always carefully check the result of delete query by pressing the datasheet button before actually deleting records by pressing the run button.

2.4. Static Table Update System “StaUp”

A new data structure and set of tools were developed for managing tables that contain calculated values (*‘static tables’*). Running a set of predefined queries creates the data in these tables. These queries pull the values from defined source tables and perform necessary calculations to produce the result records. Later if the source tables are edited, e.g. in data cleaning procedures, the target tables must be updated to reflect the changes in the source tables.

A separate more detailed documentation “*StaUp* Manager’s Instructions” is available for the data manager to manage and use the *StaUp* system. Here only a short summary is given to show how to run *StaUp* and thus keeping the target tables up-to-date. *StaUp* keeps also a record of the run times of different queries. Some of these are quite lengthy and should be run overnight. You can consider the previous run times when thinking of updating a static table.

To run *StaUp* do the following:

- 1 Open Access
- 2 Log on as LADMIN (NOTE: You need to have rights to delete data)
- 3 Open the tool database
- 4 Open [Static table update form] form

Update	Target table:	Source table:	Append query:	Last run:	Suc	Length of run:
<input checked="" type="checkbox"/>	Ambient daily	Fixed	Summary Fixed daily	13.10.1998 13:30:31	<input checked="" type="checkbox"/>	0:06:59
<input checked="" type="checkbox"/>	Ambient daily	Met	Summary Met daily	13.10.1998 13:19:45	<input checked="" type="checkbox"/>	0:00:51
<input checked="" type="checkbox"/>	Ambient summary	Fixed	Summary Fixed all	13.10.1998 13:32:22	<input checked="" type="checkbox"/>	0:01:45
<input checked="" type="checkbox"/>	Ambient summary	Fixed	Summary Fixed not null	13.10.1998 13:23:32	<input checked="" type="checkbox"/>	0:02:12
<input checked="" type="checkbox"/>	Ambient summary	Fixed	Summary Fixed null	13.10.1998 13:21:19	<input checked="" type="checkbox"/>	0:00:30
<input checked="" type="checkbox"/>	Ambient summary	Fixed	Summary Fixed zero	13.10.1998 13:20:49	<input checked="" type="checkbox"/>	0:00:52
<input checked="" type="checkbox"/>	Ambient summary	Met	Summary Met all	13.10.1998 13:19:56	<input checked="" type="checkbox"/>	0:00:11
<input checked="" type="checkbox"/>	Ambient summary	Met	Summary Met not null	13.10.1998 13:18:54	<input checked="" type="checkbox"/>	0:00:14
<input checked="" type="checkbox"/>	Ambient summary	Met	Summary Met null	13.10.1998 13:18:39	<input checked="" type="checkbox"/>	0:00:02
<input checked="" type="checkbox"/>	Ambient summary	Met	Summary Met zero	13.10.1998 13:18:36	<input checked="" type="checkbox"/>	0:00:13
<input checked="" type="checkbox"/>	Datelimits	Fixed	DC Fixed datelimits	13.10.1998 11:58:49	<input checked="" type="checkbox"/>	0:02:22
<input checked="" type="checkbox"/>	Datelimits	Met	DC Met datelimits	13.10.1998 11:56:27	<input checked="" type="checkbox"/>	0:00:03
<input checked="" type="checkbox"/>	Fixedruns	Dur OK	Fixed run avg	9.10.1998 16:45:25	<input checked="" type="checkbox"/>	1:50:41
<input checked="" type="checkbox"/>	Fixedruns	Dur OK	Met run avg	9.10.1998 14:54:43	<input checked="" type="checkbox"/>	1:45:37
<input checked="" type="checkbox"/>	Fixedruns	Eruns	Fixed run avg	9.10.1998 16:45:25	<input checked="" type="checkbox"/>	1:50:41
<input checked="" type="checkbox"/>	Fixedruns	Eruns	Met run avg	9.10.1998 14:54:43	<input checked="" type="checkbox"/>	1:45:37
<input checked="" type="checkbox"/>	Fixedruns	Esamples	Fixed run avg	9.10.1998 16:45:25	<input checked="" type="checkbox"/>	1:50:41
<input checked="" type="checkbox"/>	Fixedruns	Esamples	Met run avg	9.10.1998 14:54:43	<input checked="" type="checkbox"/>	1:45:37
<input checked="" type="checkbox"/>	Fixedruns	Fixed	Fixed run avg	9.10.1998 16:45:25	<input checked="" type="checkbox"/>	1:50:41
<input checked="" type="checkbox"/>	Fixedruns	Met	Met run avg	9.10.1998 14:54:43	<input checked="" type="checkbox"/>	1:45:37

Fields of the form:

- Update = select this to delete all data from target table and execute the append query
 Target table = name of the target table which will be cleared and rebuilt
 Source table = name of the source table from which the data will be calculated
 Append query = name of the query which will be run
 Last run = time when the append query was last run
 Suc = indicator if the last run was completed successfully
 Length of run = Duration of last run [hh:mm:ss]

NOTE: When a query fails, the table [DBMt Static queries] contains error information.

Find the reason why the query was not successful, fix the error and run the update query again.

- 5 Select the targets you want to build or update

When the Update-button is clicked contents of all checked target tables are deleted and the queries listed in the append query column are executed.

When you check an Update box on one row, all rows having the same target table are checked, because the target is first fully cleared and multiple queries probably need to be run to re-built the target. If this is not what you intend to do, you can de-check unwanted rows.

3. MET, FIXED, FIXEDRUNS AND AMBIENTTOOL DATABASES

The fixed station ambient air quality measurement results are stored in FIXED.MDB. MET.MDB contains corresponding meteorological data. Detailed statistics of ambient air quality and meteorology for each Expolis sample are stored in FIXEDRUNS.MDB. MET, FIXED and FIXEDRUNS only store data, all calculations are done using queries in AMBIENTTOOL.MDB.

The AMBIENTTOOL database is linked also to several tables in the EADB. When installing the Expolis Ambient databases, these links must be updated to point correctly to the local data database file (e.g. ATHENS.MDB).

3.1. Installing the Expolis Ambient Database

All Expolis data files should reside in a common directory called DATA in each center. Installation of Expolis Ambient database consists of two steps

1. Copy the 4 database files to the DATA directory
2. Re-link linked tables in the AMBIENTTOOL.MDB to point correctly to the data databases
 - EADB local database (e.g. ATHENS.MDB)
 - FIXED, MET and FIXEDRUNS.MDB

Linking tables is done using Access add-in called linked table manager. The linking procedure is described on a separate instruction sheet. If the Linked Table Manager add-in is not available in your workstation, you need to install Access Developer tools from the Access installation CD-ROM.

3.2. Tables in the FIXED.MDB database

Next picture shows the tables in the FIXED database.

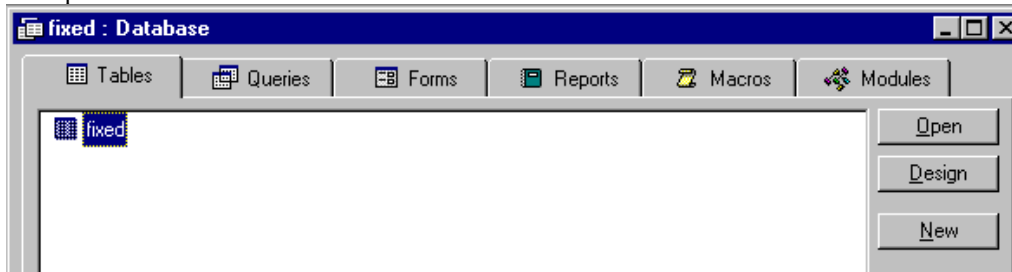

Table [fixed] contains all the hourly concentrations measured at the fixed stations. Helsinki parameters and the database measurement units are listed below: (same measurement units must be used in each city)

Parameter	Variable	Explanation
■ Date and time	Date	Local time or local daylight savings time, whichever is applicable
■ SO ₂	SO2	Hourly average of sulphur dioxide concentration [$\mu\text{g}/\text{m}^3$]
■ NO	NO	Hourly average of nitrogen oxide concentration [$\mu\text{g}/\text{m}^3$]
■ NO ₂	NO2	Hourly average of nitrogen dioxide concentration [$\mu\text{g}/\text{m}^3$]
■ O ₃	O3	Hourly average of ozone concentration [$\mu\text{g}/\text{m}^3$]
■ PM ₁₀	PM10	Hourly average of PM ₁₀ concentration [$\mu\text{g}/\text{m}^3$]
■ PM _{2.5}	PM2_5	Hourly average of PM _{2.5} concentration [$\mu\text{g}/\text{m}^3$]
■ TSP	TSP	Hourly average of particulate matter concentration [$\mu\text{g}/\text{m}^3$] (not Helsinki)
■ CO :	CO	Hourly average of carbon monoxide concentration [mg/m^3]

In Helsinki some meteorological parameters were measured also by the air quality network. These values can be entered to the FIXED database, but it is not compulsory. Also, if you locally do have some hourly or daily parameters not listed above, please include them in the database too.

Parameter	Variable	Explanation
■ Wind speed	Wspd	[m/s]
■ Wind direction	Wdir	0-360° (0 = N, 90 = E)
■ Temperature	Temp	[°C]
■ Rain	Rain	[%] (Percentage of time having rain during each hour)
■ Relative humidity	Rhum	[%]

The structure of the table fixed is presented below. First three variables (key variables) are indexed to ensure maximum performance.

The screenshot shows the 'fixed : Table' design view in Microsoft Access. It displays a table with four fields: Date, Site, Comp, and Value. Below the table is the 'Field Properties' task pane, which is currently on the 'General' tab. The 'Indexed' property is set to 'Yes (Duplicates OK)'. A help message is visible on the right side of the task pane.

Field Name	Data Type	Description
Date	Date/Time	Date and time, beginning of averaging period (local time, daylight saving time)
Site	Text	Measurement site code (5 chars)
Comp	Text	Quantity measured
Value	Number	The value of measurement

Field Properties

General | Lookup

Format: [Dropdown]

Input Mask: [Text Box]

Caption: [Text Box]

Default Value: [Text Box]

Validation Rule: [Text Box]

Validation Text: [Text Box]

Required: No

Indexed: Yes (Duplicates OK)

The display layout for the field. Select a pre-defined format or enter a custom format. Press F1 for help on formats.

3.3. Tables in the MET.MDB database

The picture below presents the tables in MET.mdb.

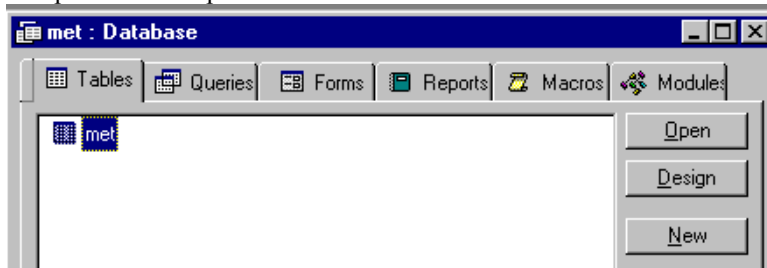

The basic structure of the table [met] is identical with the table [fixed]. Only difference is that in met the measurements are completed in three-hour intervals. Note that the times in [met] must be presented in local time, or during the summertime in daylight saving time if applicable. In Finland daylight saving time was 31.3. 03:00 – 27.10 03:00 in 1996 and 30.3. 03:00 – 26.10. 03:00 in 1997.

The values of table [met] must be in following measurement units (following the World Meteorological Organization WMO practices, synoptic meteorological observations).

Parameter	Variable	Explanation
■ Date and time	Date	Local time or local daylight savings time, whichever is applicable
■ Air pressure	pres	[hPa], Instant value observed in 3-hour intervals, clock 0, 3, 6, ... in GMT
■ Cloudiness	clou	[1/8],--
■ Relative humidity	hum	[%],--
■ Air temperature	temp	[°C],--
■ TDEW	tdew	[°C],--
■ TWET	twet	[°C],--
■ Visibility	visi	[m],--
■ Wind direction observed in 3-hour intervals	widd	° (0-360, N=0, E=90), 10 minute average
■ Wind speed :	wims	[m/s],--

NOTE: Wind direction is the direction from which the wind is blowing

Modeled values (if available)

■ Mixing height:	[m]	3-hourly value
■ Monin-Obhukov inverse length	[1/m]	--

NOTE: ATMOSPHERIC PRESSURE MEASUREMENT UNITS (24.5.2002)

1 atm = 760 mmHg = 1.013 bar = 101.325 kPa normal atmospheric pressure

1 bar = 1E5 Pa = 100 kPa

1 mbar = 1E2 Pa = 1 hPa

the unit used in the **met.mdb** for meteorological observations

1 torr = 1 mmHg = 0.133322 kPa

the unit used in the **local.mdb** for laboratory conditions

Conversion from mbar = hPa to torr = mmHg:

$$p_{mmHg} = p_{mbar} \times \frac{760}{1013.25} \times \frac{mmHg}{mbar} = p_{mbar} \times 0.75006 \frac{mmHg}{mbar}$$

3.4. Tables in the FIXEDRUNS.mdb database

Next picture shows the tables in the FIXEDRUNS.mdb.

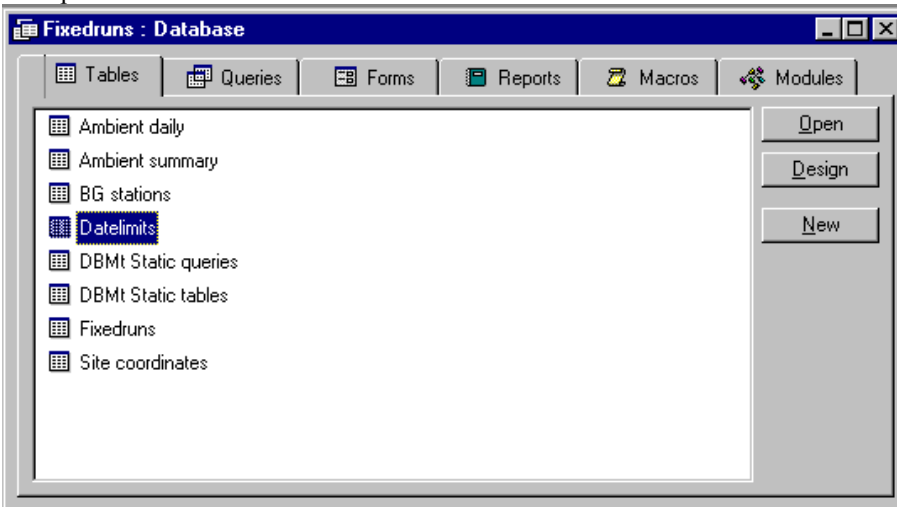

[Ambient daily], [Ambient summary] and [Datelimits] are static tables in which the values are calculated from other tables. If the source tables are edited, these tables must be updated using the static table updating system described on page 20.

Table [Ambient daily] shows daily basic statistics for all parameters in tables [Fixed] and [Met].

Field Name	Data Type	Description
Site	Text	Site code of the measurement site (max. 5 chars)
Comp	Text	Component code
Date	Date/Time	Date for which the statistics have been calculated
Avg	Number	Average of the Comp at Site during Date
Min	Number	Minimum of the Comp at Site during Date
Max	Number	Maximum of the Comp at Site during Date
StDev	Number	StDev of the Comp at Site during Date
n	Number	Number of non-Null observation of the Comp at Site during Date

Field Properties

General Lookup

Field Size 5

Table [Ambient summary] shows the counts of values of each type (all, non-null, null or zero) in tables [Fixed] and [Met].

Field Name	Data Type	Description
db	Text	Name of the database file (MET.MDB or FIXED.MDB)
Comp	Text	Measured quantity (e.g. pollution compound)
Site	Text	Measurement site code (max 5 chars)
type	Text	Type of records counted: Null, Zero, Value (=not null) or All
cnt	Number	Number of records with this type of value

Field Properties

General Lookup

Field Size 10

Table [BG stations] shows the background station of each city (A, B, G, H, M, P).

Field Name	Data Type	Description
Count	Number	
City	Text	
BGstation	Text	

Field Properties

General | Lookup

Field Size: 1

Format:

Input Mask:

A field name can be up to 64 characters long, including spaces. Press F1 for help on field names.

[Datelimits] lists starting and ending times of measurement of each component at each station, calculated by queries [DC fixed datelimits] and [DC Met datelimits].

Field Name	Data Type	Description
Site	Text	Site code
Comp	Text	Measured quantity
Start	Date/Time	First date with non-null data for this site/component combination
End	Date/Time	Last date with non-null data for this site/component combination

Field Properties

General | Lookup

Field Size: 5

Table [Fixedruns] contains ambient air parameter statistics for each sample. The creation of this table is presented in later in this document.

Field Name	Data Type	Description
Site	Number	Expolis sample id
Site	Text	Fixed station measurement site
Comp	Text	Fixed station component
Avg	Number	Average value for the Expolis sample run period(s)
Min	Number	Minimum value for the Expolis sample run period(s)
Max	Number	Maximum value for the Expolis sample run period(s)
Stdev	Number	Standard deviation of value for the Expolis sample run period(s)
Cov	Number	Number of hourly fixed station observations per duration of Expolis sample (in hours) x 100
n	Number	Number non-null fixed station observations

Field Properties

General | Lookup

Field Size: Long Integer

Format: General Number

Decimal Places: Auto

Input Mask:

Caption:

Default Value:

Validation Rule:

Validation Text:

Required: No

Indexed: Yes (Duplicates OK)

A field name can be up to 64 characters long, including spaces. Press F1 for help on field names.

The coordinates of the fixed and met stations are represented in table [Site coordinates].

Field Name	Data Type	Description
Sitename	Text	Full name of measurement site
Site	Text	Site code (5 chars)
N	Number	North coordinate [m]
E	Number	East coordinate [m]

Field Properties

General | Lookup

Field Size: 50

[DBMt Static queries] and [DBMt Static tables] are part of the static table updating system. Updates and other calculations in MET.mdb, FIXED.mdb and FIXEDRUNS.mdb are done with queries in the AmbientTOOL.mdb.

3.5. AMBIENTTOOL.MDB database

All queries used in processing the ambient data are included in the AMBIENTTOOL.MDB. They are shown in the picture below:

Query Name	Query Name	Query Name	Query Name
CE Ambient cityavg c	DBMq StaUp table update Sub	Met run avg	Summary Fixed zero
CE Ambient nearest st c	DC Delete nulls	Met run avg sub	Summary Met all
CE Distances all	DC Fixed averages	Sid sampling ranges	Summary Met daily
CE Distances home subquery	DC Fixed datelimits	Sites and comp	Summary Met not null
CE Distances nearest home	DC Met averages	Summary ambient crosstab	Summary Met null
CE Distances nearest work	DC Met datelimits	Summary ambient daily	Summary Met zero
CE Distances work subquery	DC Normalize	Summary Fixed all	
CE Sampling range P	Dur OK	Summary Fixed daily	
Dateserial	Fixed run avg	Summary Fixed not null	
DBMq StaUp table update	Fixed run avg sub	Summary Fixed null	

Buttons: Open, Design, New

In AmbientTOOL queries fall into following categories:

- Data cleaning queries, [DC...]
- Append queries to fill in empty tables or to update static tables
- Queries to calculate concentration averages into [Fixedruns] table
- Distance queries calculating distances between homes, workplaces and measurement stations
- Subqueries supporting above listed categories

4. IMPORTING MET AND FIXED DATA INTO ACCESS

The Ambient air quality and meteorological data must be obtained on diskettes or in other computer compatible form. This data is then imported to the FIXED.MDB and MET.MDB databases. Suggested procedure is to

- import the raw data tables into Access in the raw format ('as they are') and then
- transform the row/column format to the Expolis Ambient database format

The time stamp of data records must be comparable to the EADB time stamps in [ERuns] table. This means that day light savings time and local time corrections must be made, if the original data does use some other time definition.

It is of course possible to do the row/column format transformation along with other possibly needed time zone and measurement unit conversions also in some other environment, e.g. Excel. The following short introduction presents the procedure using MS-Access.

NOTE: meteorological observations are often stamped using Greenwich Mean Time.

In this case both local time and daylight savings time corrections must be applied to the time stamps.

4.1. Importing data from Excel or other primary data format

In the Access approach the first task is to move raw data into Access.

From the File menu select get external data and then import. After importing all tables (e.g. worksheets), they are normalized to Expolis Ambient database format using queries in the AMBIENTTool.MDB database.

4.2. Combining date and time fields with [Dateserial]

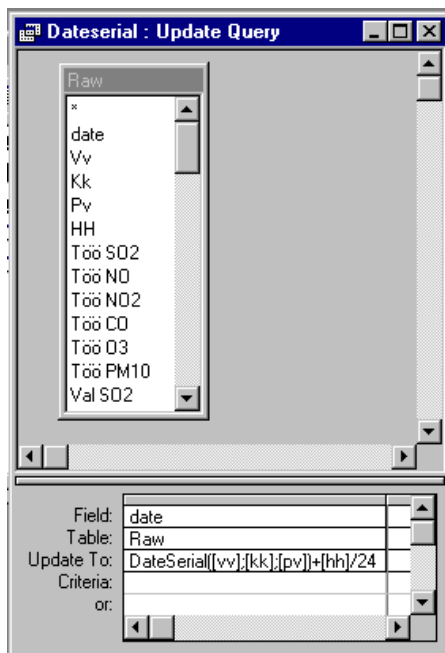

In some cases the year, month, day, hour and minute are coded as separate variables and the values are in different fields in the input file (as was the case in Helsinki). In this case they must be combined to the full date and time format used in Access. This can be done with the query [Dateserial], shown below. (vv = year, kk = month, pv = day of month).

NOTE: Conversion from GMT to local time and the daylight savings time corrections must be done separately, if applicable!

4.3. [DC Normalize], Normalization of the imported data tables

In many cases the ambient data is stored in spreadsheet files having the date/time in the first column and then many columns of data for different stations and different pollutants (or other parameters). Example of Helsinki data in the figure below shows this case.

Hourly values				Too SO2	Too NO	Too NO2	Too CO	Too O3	Too PM10	Val SO2	Val NO	Val NO2
Year	Month	Day	Hour	µg/m3	µg/m3	µg/m3	mg/m3	µg/m3	µg/m3	µg/m3	µg/m3	µg/m3
96	4	1	0	5	10	21	0.4	75	19	3	4	44
96	4	1	1	4	6	15	0.2	80	18	2	0	24
96	4	1	2	3	5	9	0.3	88	17	2	0	22
96	4	1	3	4	3	12	0.3	86	18	2	0	18
96	4	1	4	3	4	10	0.3	84	18	2	0	33
96	4	1	5	3	24	34	0.4	63	20	2	4	43
96	4	1	6	5	51	46	0.6	53	24	3	14	58
96	4	1	7	5			1.3	42	27	2	15	57
96	4	1	8	9	97	71	1.5	33	29	2	15	52
96	4	1	9	14	101	74	1.3	34	31	3	10	38
96	4	1	10		82	73	1.1	31	36	3	10	37
96	4	1	11	20	95	76	1.1	27	32	2	12	35
96	4	1	12	17	97	72	1.1	31	29	3	9	29
96	4	1	13	11	78	55	1	46	26	4		

Figure 2. Example of raw ambient air quality data from Helsinki (only beginning of the file is shown both column and row wise). “Too” and “Val” are measurement stations in Helsinki.

The data row/column format in Expolis Ambient database is called *normalized* in the relational database terminology. This means that each row (record) contains exactly one piece of related information, e.g. one measured concentration.

In practice this means that the number of columns is decreased and the number of rows in the destination table is increased, as shown in the example below.

Date	Site	Compo	Value
1.4.1996 1:00:00	Too	CO	0.2
1.4.1996 1:00:00	Too	NO	6
1.4.1996 1:00:00	Too	NO2	15
1.4.1996 1:00:00	Too	O3	80
1.4.1996 1:00:00	Too	PM10	18
1.4.1996 1:00:00	Too	SO2	4
1.4.1996 1:00:00	Too	Temp	-1.7
1.4.1996 1:00:00	Val	CO	0.3
1.4.1996 1:00:00	Val	NO	0
1.4.1996 1:00:00	Val	NO2	24
1.4.1996 1:00:00	Val	SO2	2

Figure 3. Ambient data in normalized form in the Expolis Ambient database.

Normalization of columns into rows in the Access table can be done using query [DC Normalize]. [DC Normalize] selects the date and specified value field from the raw data table and assigns relevant values for [site] and [comp] fields. The results are appended to the [fixed] or [met] table.

[DC Normalize] must be evaluated once for each value column in the raw data table (i.e., the number of combinations of site and component). It is on user's responsibility to enter the correct [site] and [comp] labels corresponding the value field in each round.

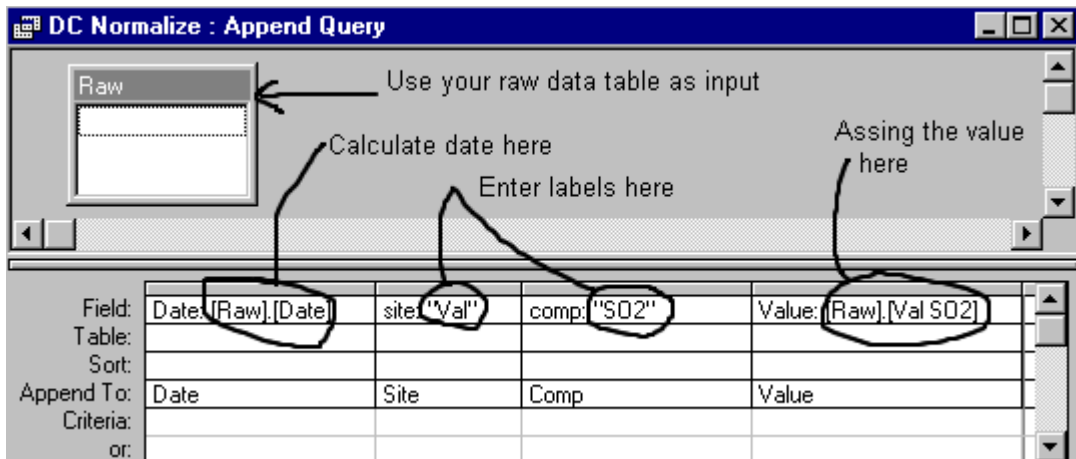

You can use the [DC Normalize] query to normalize and append values both to the [fixed] table and to the [met] table. The query shipping with the AMBIENTTOOL.MDB is linked to [fixed] table. To change the appended table, open the [DC Normalize] query in desing view and select Query – Append from the menu. Then in the dialog below select the table where to append the values.

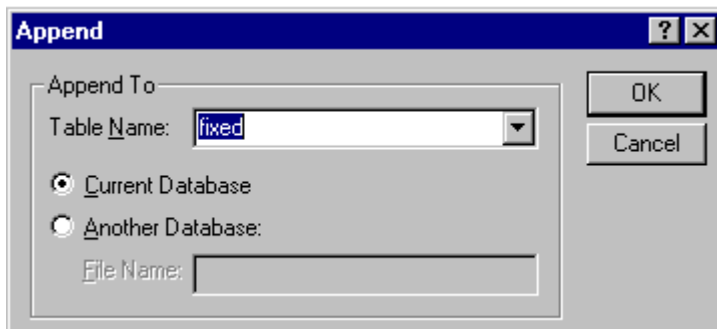

After all data has been normalized and appended to the [met] and [fixed] tables, the raw data import tables should be archived in a backup copy of the MET and FIXED databases and removed from the databases to be sent to KTL.

5. StaUp in AMBIENTTOOL

The next sections will describe the data processing queries used in the Expolis Ambient database. Before the ambient data is combinable to Expolis measurements, the ambient data must be cleaned and several static tables must be created. All queries updating or creating static tables are included in the **Static Table Update System (StaUp)**.

StaUp allows user to run multiple queries in unattended batch mode, e.g. during the night. Because the size of the ambient data is large, many queries might run from tens of minutes to hours. The StaUp is used via a form called [Static table update form]. This is shown below.

Update	Target table:	Source table:	Updating query:	Date of last run:	Suc	Duration:
<input type="checkbox"/>	Ambient daily	Fixed	Summary Fixed daily	14.10.1998 9:54:31	<input type="checkbox"/>	0:00:00
<input checked="" type="checkbox"/>	Ambient daily	Met	Summary Met daily	14.10.1998 10:08:30	<input type="checkbox"/>	0:01:11
<input type="checkbox"/>	Ambient summary	Fixed	Summary Fixed all	14.10.1998 9:54:33	<input type="checkbox"/>	0:00:01
<input type="checkbox"/>	Ambient summary	Fixed	Summary Fixed not null	14.10.1998 9:54:30	<input type="checkbox"/>	0:00:00
<input type="checkbox"/>	Ambient summary	Fixed	Summary Fixed null	14.10.1998 9:54:29	<input type="checkbox"/>	0:00:01
<input type="checkbox"/>	Ambient summary	Fixed	Summary Fixed zero	14.10.1998 9:54:28	<input type="checkbox"/>	0:00:01
<input type="checkbox"/>	Ambient summary	Met	Summary Met all	14.10.1998 10:05:08	<input type="checkbox"/>	0:00:13
<input type="checkbox"/>	Ambient summary	Met	Summary Met not null	14.10.1998 10:04:55	<input type="checkbox"/>	0:00:17
<input type="checkbox"/>	Ambient summary	Met	Summary Met null	14.10.1998 10:04:37	<input type="checkbox"/>	0:00:03
<input type="checkbox"/>	Ambient summary	Met	Summary Met zero	14.10.1998 10:04:34	<input type="checkbox"/>	0:00:09
<input type="checkbox"/>	Datelimits	Fixed	DC Fixed datelimits	14.10.1998 9:54:34	<input type="checkbox"/>	0:00:00
<input type="checkbox"/>	Datelimits	Met	DC Met datelimits	14.10.1998 9:54:33	<input type="checkbox"/>	0:00:00
<input type="checkbox"/>	Fixedruns	Dur OK	Fixed run avg	9.10.1998 16:45:25	<input type="checkbox"/>	1:50:41
<input type="checkbox"/>	Fixedruns	Dur OK	Met run avg	13.10.1998 19:07:02	<input type="checkbox"/>	5:34:38
<input type="checkbox"/>	Fixedruns	Eruns	Fixed run avg	9.10.1998 16:45:25	<input type="checkbox"/>	1:50:41
<input type="checkbox"/>	Fixedruns	Eruns	Met run avg	13.10.1998 19:07:02	<input type="checkbox"/>	5:34:38
<input type="checkbox"/>	Fixedruns	Esamples	Fixed run avg	9.10.1998 16:45:25	<input type="checkbox"/>	1:50:41
<input type="checkbox"/>	Fixedruns	Esamples	Met run avg	13.10.1998 19:07:02	<input type="checkbox"/>	5:34:38
<input type="checkbox"/>	Fixedruns	Fixed	Fixed run avg	9.10.1998 16:45:25	<input type="checkbox"/>	1:50:41
<input type="checkbox"/>	Fixedruns	Met	Met run avg	13.10.1998 19:07:02	<input type="checkbox"/>	5:34:38

Buttons: All, None, View StaUp results, Update, Close. Status: 141098 eKa. Record: 1 of 20.

For the first time all queries should be run. Press the All button and then click Update.

After data cleaning some source tables might have been changed. In this case all target tables that rely on modified source tables must be rebuilt. Deselect first all targets by pressing None button. Then check all targets that must be rebuilt and then click Update.

The Duration column shows the duration of last run of each query. These durations summed for all checked targets is a rough estimate of the time needed to rebuild selected target tables.

NOTE: All records are first removed from checked targets tables when Update is pressed.

When selecting a target table, all other queries affecting this target are by default selected too.

6. DATA CLEANING

The goal of Ambient database data cleaning is to remove long continuous series of null (missing) values from the database and to ensure that the remaining values are reasonable. To do this, some basic summary and time series statistics of the data are calculated.

Data cleaning is facilitated by two sets of queries in the AMBIENTTOOL.

- Crosstabs These count records for Site-Compound combinations with criteria for value (Null, 0, non-Null, All)
- Time series These produce daily statistics (avg, min, max, std, count of non-Null values)

NOTE: missing code (e.g. -9) is not used in the Ambient database.

If some other code than Null is used, it must be handled separately when calculating averages etc.

Crosstabs and time series queries are time consuming to run, and thus the results are stored in static tables for later reference. The crosstab summaries should be printed for both [fixed] and [met] tables for all four different value types (Null, 0, non-Null, All). The time series summaries should be printed for all site/compound combinations.

The summary printouts are checked for illegal/out of scale values and any necessary corrections to the data are done. Continuous series of Null values (e.g. equipment malfunction) are removed (see [DC Delete Nulls] query later).

The summary printouts are filed with the Ambient database documentation for later reference and copies are sent to KTL with the database files.

6.1. [Summary Fixed 'type'] and [Summary Met 'type'] queries

These queries build up the [Ambient summary] table containing the record counts of all site-component combinations in [fixed] and [met] tables for four different types of values:

Type	Specified criteria	Interpretation
All	No Criteria specified	total number of records
Null	Value = Null	number of Null values
Zero	Value = 0	number of zero values
Not null	Value is not null	number of non-null values (=not missing values)

The query [Summary Fixed all] is shown below as an example of these 8 queries.

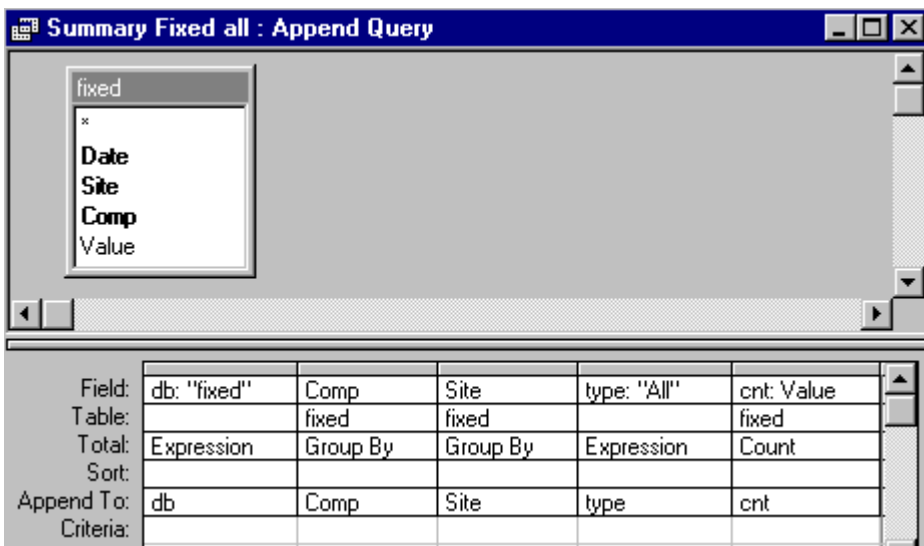

A crosstab query [Summary Ambient crosstab] can be used to make printouts of record counts for data cleaning purposes. The [type] field criteria must be manually set to desired value in query design view:

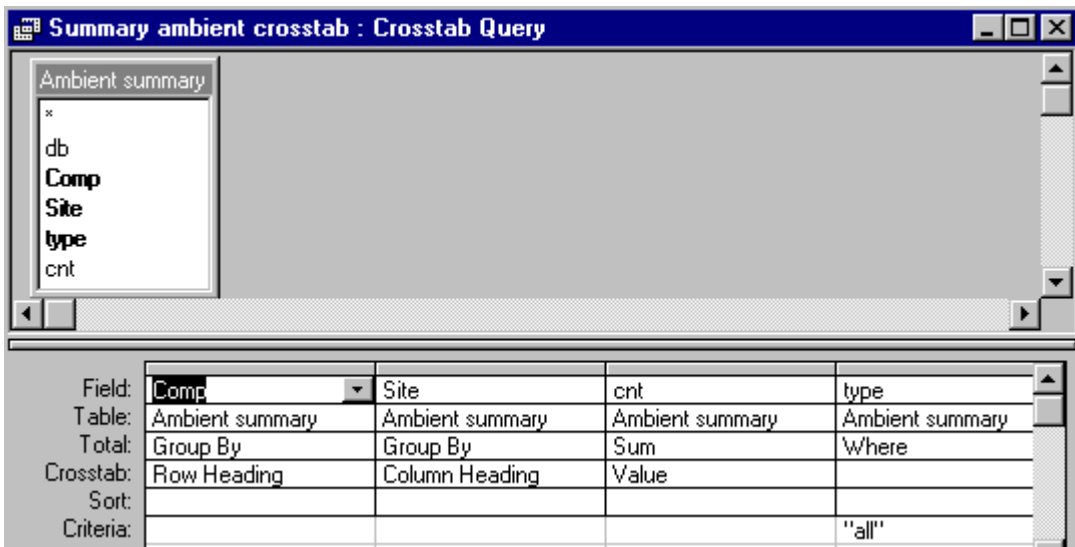

Select above which type of record counts you want (All, Zero, Null, Value (=non-Null values)).

The figure below shows an example of the [Summary ambient crosstab] query output.

Component	Total	Kal	Lep	Luu	sHak	sLaa	sRun	sSor	sTam	sTapr	Tik	Too	Val	Count
CO	100028		14869		12824		15199	6535		5548	14807	15149	15097	8
NO	138598		14907	14996	15162	15143	15084	6263	6225	6232	14912	14958	14716	11
NO2	138388		14905	14839	15162	15142	15084	6215	6225	6231	14912	14958	14715	11
O3	68694			15223			8296				15196	15203	14776	5
PM10	56399		14170		13817							14681	13731	4
PM2,5	13213												13213	1
SO2	73367		14966	14621							14673	14600	14507	5
Count		0	5	4	4	2	4	3	2	3	5	6	7	45
Temp	41958	15097		15293								11568		3
Wdir	51425	15097	15302		14436				6590					4
Wspd	51422	15097	15301		14434				6590					4
Rain	29518	15097		14421										2
Rhum	14171	14171												1

Figure 4. Example of Fixed cross-tab: number of non-null records in Helsinki data.

6.2. Time series: [Summary Fixed daily], [Summary Met daily]

These queries construct table [Ambient daily], which contains daily basic statistics for all combinations of site and component. The averages can be graphed using e.g. Excel, as a function of date over the Expolis field period to check quickly if there are any suspicious values. The printouts are archived for later reference.

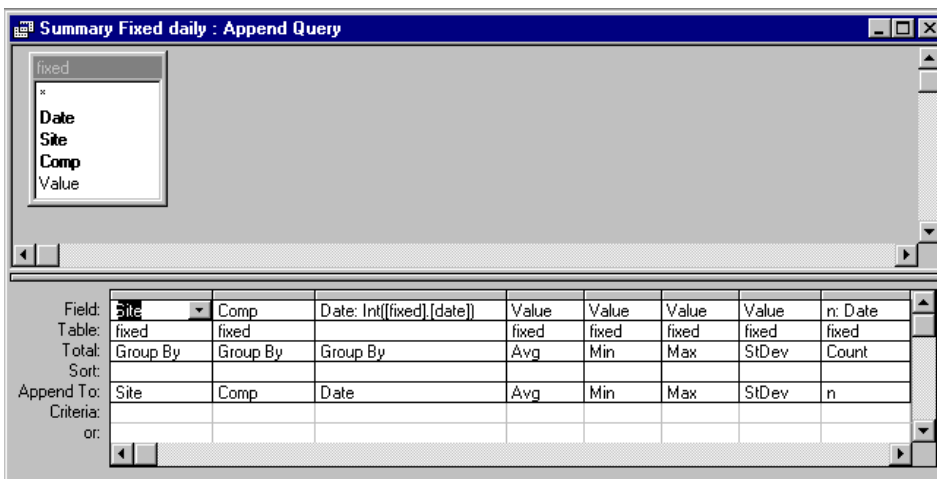

6.3. [DC Fixed datelimits], [DC Met datelimits]

Datelimits queries list minimum and maximum of dates for all combinations of site and component where the value of the measurement is not null. The rationale is that we try to reveal long continuous sequences of null values indicating time ranges when measurement equipment was not running. Dropping these null sequences can substantially save disk space.

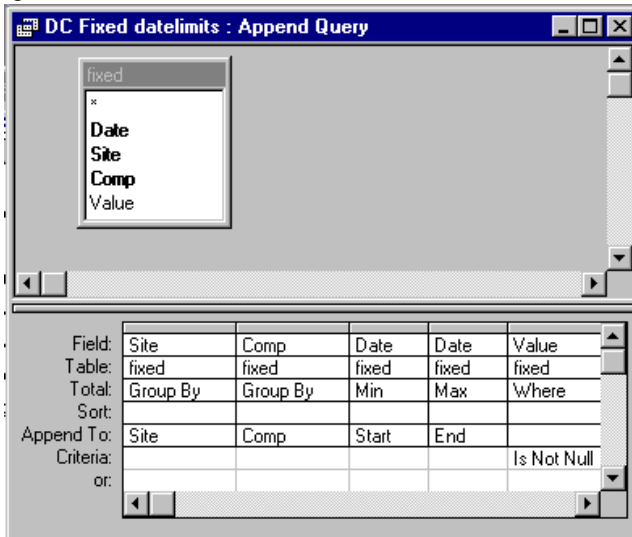

6.4. [DC Deletenulls]

The following delete query deletes records fulfilling criteria determined, for example, by datelimits or crosstab queries. For example, at one site in Helsinki NO and NO2 were not measured after 31.12.1996 23:00. Since data is stored at one-hour precision in table fixed, there were over 15 000 useless records for NO and NO2.

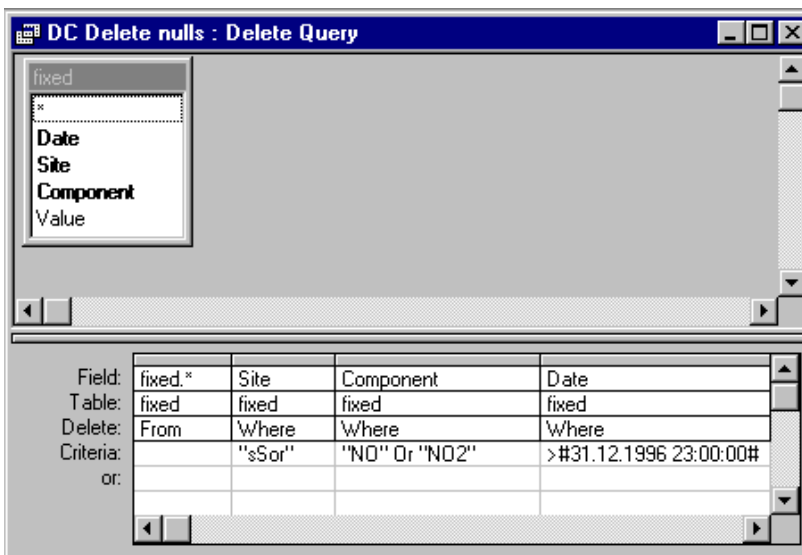

It is up to the user to make sure, that the data limits specified as criteria in [Date] column are correct so that no true data is removed.

6.5. [DC Fixed statistics], [DC Met statistics]

These queries calculate the basic statistics for each site and component. If there are unreasonable values, we can search for them, for example, using find. Consult the monitoring/measurement network personnel if the data point is valid or not, and correct the data, remove the data or leave it as is, whichever is applicable.

The screenshot shows a software window titled "DC Fixed statistics : Select Query". The window contains a list of fields: "Date", "Site", "Comp", and "Value". Below the list is a table with the following structure:

Field:	Site	Comp	Value	Value	Value	Value	Value
Table:	fixed	fixed	fixed	fixed	fixed	fixed	fixed
Total:	Group By	Group By	Avg	Min	Max	StDev	Count
Sort:							
Show:	<input checked="" type="checkbox"/>	<input checked="" type="checkbox"/>	<input checked="" type="checkbox"/>	<input checked="" type="checkbox"/>	<input checked="" type="checkbox"/>	<input checked="" type="checkbox"/>	<input checked="" type="checkbox"/>
Criteria:							

7. CREATING FIXEDRUNS.MDB DATABASE

The FIXEDRUNS.MDB database contains statistics of ambient parameters for all samples calculated from their sampling periods (runs). All statistics are calculated using queries [Fixed run avg] and [Met run avg] in the AmbientTOOL database.

Following pictures show [Fixed run avg] and [Met run avg].

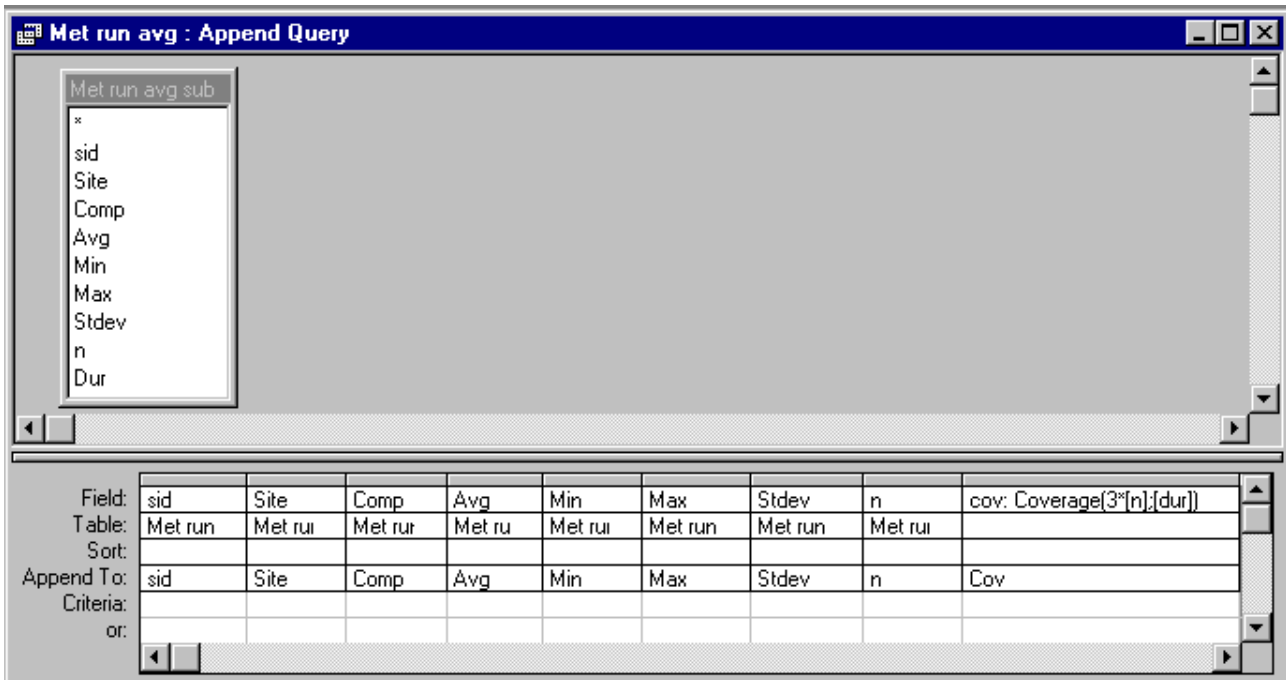
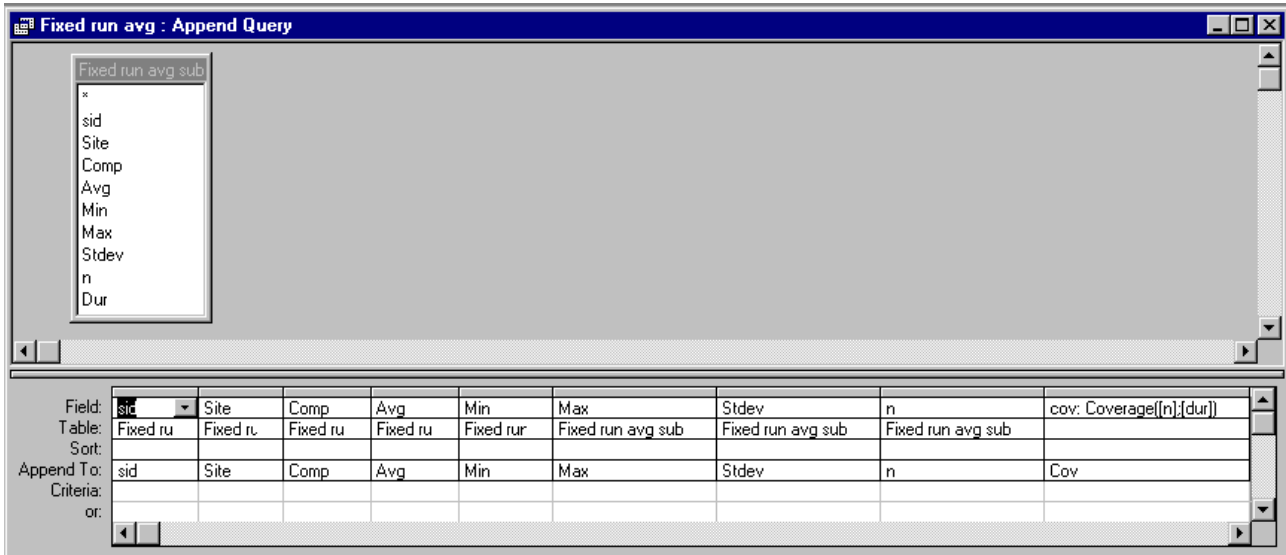

Field cov is calculated using function [Coverage], which is presented in ch. 9.1.7.

NOTE: Calculation of coverage field [cov] is based on assumption that fixed data is hourly and met data is 3-hourly.

Subqueries [Fixed run avg sub] and [Met run avg sub] are used by above queries. [Fixed run avg sub] is presented below.

The screenshot shows a query window with the following table structure:

Field:	Table:	Site	Comp	Avg: Value	Min: Value	Max: Value	Stdev: Value	n: Value	Dur: dur	Date	Value	MaxOfrok
sid	ESamples	fixed	fixed	fixed	fixed	fixed	fixed	fixed	fixed	fixed	fixed	fixed
Total:	Group By	Group By	Group By	Avg	Min	Max	StDev	Count	First	Where	Where	Where
Sort:												
Show:	<input checked="" type="checkbox"/>	<input checked="" type="checkbox"/>	<input checked="" type="checkbox"/>	<input checked="" type="checkbox"/>	<input checked="" type="checkbox"/>	<input checked="" type="checkbox"/>	<input checked="" type="checkbox"/>	<input checked="" type="checkbox"/>	<input checked="" type="checkbox"/>	<input type="checkbox"/>	<input type="checkbox"/>	<input type="checkbox"/>
Criteria:	or: >=[Start] And <=[End] Is Not Null <>3											

8. NEAREST STATION CONCENTRATIONS

The purpose of Expolis Ambient database is to calculate city average concentrations, background station concentrations and nearest station concentrations corresponding each Expolis sample. This section describes the draft queries calculating distances between Expolis subject home and work place coordinates and the fixed stations.

NOTE: These queries are preliminary and have not been thoroughly tested.

Also queries calculating city averages, background station averages and nearest station averages are shown.

8.1. Distance queries

The distance query section is not yet completely ready. Queries now calculate distances whether a measurement is running at a station during a customer's sampling period or not. This is to be corrected later.

The aim of the distance queries is to find for each customer the station which is located nearest his/her home and workplace. Knowing that we can investigate how precisely the concentrations measured by nearest fixed station follow the concentrations measured by the personal monitors.

8.1.1. [CE Distances all]

This query shows distances between the fixed measurement stations and customer's home site and work site. The distance is euclidean distance calculated using coordinates from the tables ECoord and Fixed coords. So, the distances have no measurement unit and they can only be compared with each other. The function EucDist is presented in ch. 9.1.7.

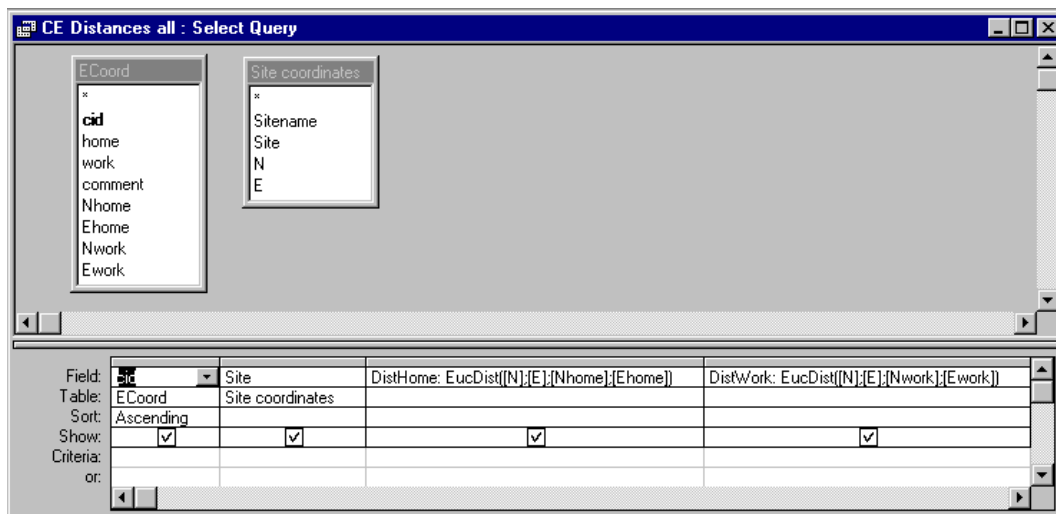

8.1.2. [CE Distances home subquery]

This query assigns relevant components to each site and finds minimum distances between homes and stations by component. This query is used by [CE Distances nearest home].

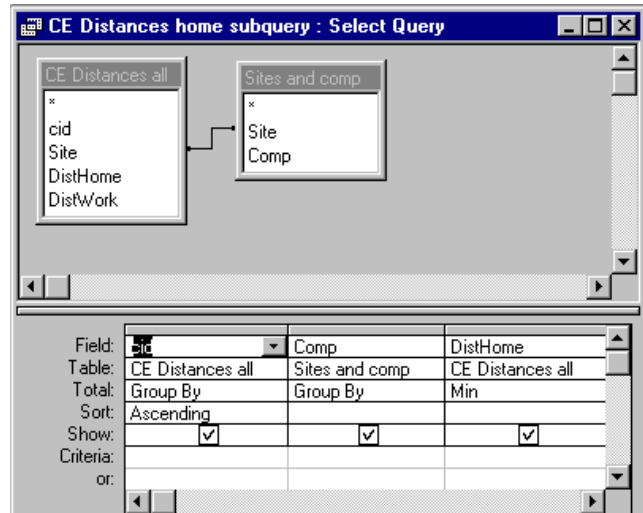

8.1.3. [CE Distances nearest home]

This query shows the fixed measurement station which is located nearest customer's home.

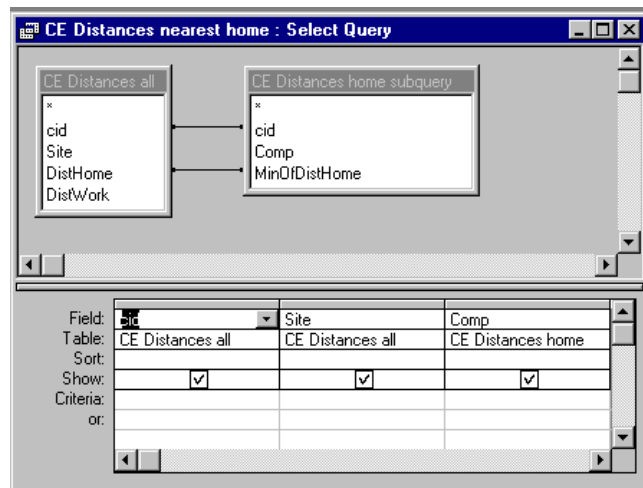

8.1.4. [CE Distances work subquery]

This query assigns relevant components to each site and finds minimum distances between work sites and stations by component. This query is used by [CE Distances nearest work].

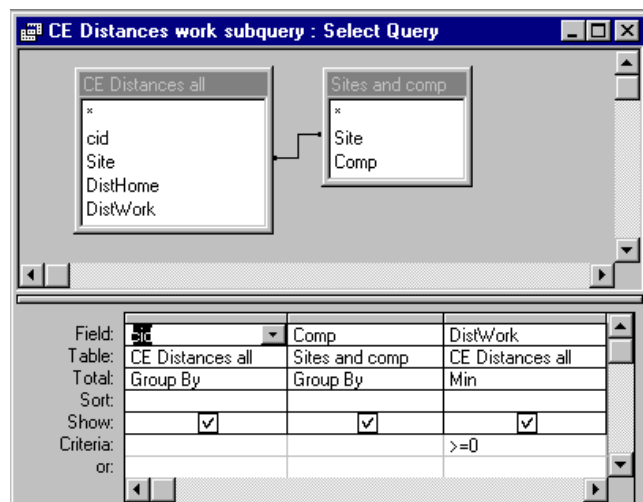

8.1.5. [CE Distances nearest work]

This query shows the fixed measurement station which is located nearest customer's work site.

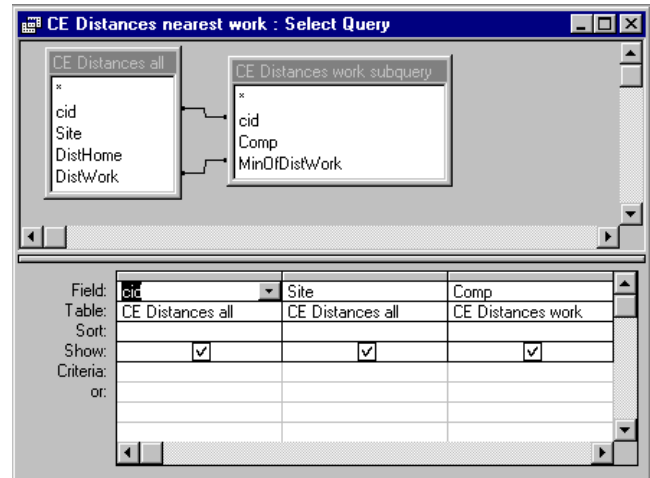

8.1.6. [Sites and comp]

This query is needed when calculating distances. It lists all measurement sites and components measured at each site.

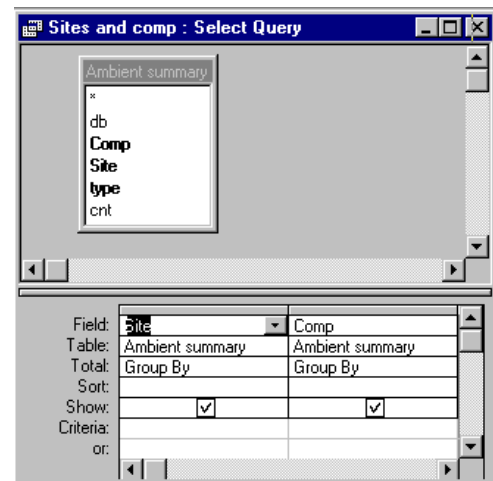

8.1.7. ExpolisCoords, module

This module includes function EucDist, which calculates the euclidean distance in [CE Distances all]. If customer has no workplace coordinates, EucDist returns corresponding code (-8 or -9). Parameters Nst, Est, Ncust, Ecust are correspondingly northern and eastern coordinate of fixed measurement station and northern and eastern coordinate of customer's home or work.

```
Public Function EucDist(Nst, Est, Ncust, Ecust) As Double
'Calculates euclidean distance between points (Nst, Est) and (Ncust, Ecust).

If (Ncust = -8) Or (Ecust = -8) Then
    EucDist = -8
Else
    If (Ncust = -9) Or (Ecust = -9) Then
        EucDist = -9
    Else
        If IsNull(Ncust) Or IsNull(Ecust) Then
            EucDist = -9
        Else
            EucDist = Sqr((Abs([Nst] - [Ncust])) ^ 2 + (Abs([Est] - [Ecust])) ^ 2)
        End If
    End If
End If
End Function
```

Module contains also function Coverage, which is needed in constructing table [Fixedruns].

```
Public Function Coverage(n, dur)
'
' Returns an integer value
'
If IsNull(n) Then
    Coverage = -8
ElseIf (n = 0) Then
    Coverage = 0
ElseIf n = -9 Then
    Coverage = -9
ElseIf n = -8 Then
    Coverage = -8

ElseIf (dur = 0) Then
    Coverage = 100
ElseIf (IsNull(dur)) Or (dur = -9) Then
    Coverage = -9
ElseIf (dur = -8) Then
    Coverage = -8
Else: Coverage = Int((n / dur) * 100)
End If

End Function
```

8.2. Ambient air queries

These queries calculate three different ambient air concentrations; nearest station, city average and city background concentrations, and compares them with each customer's personal exposure.

8.2.1. [CE Ambient nearest st c]

This query calculates nearest station concentrations. To obtain concentrations measured by stations nearest work places, just replace [CE Distances nearest home] with [CE Distances nearest work].

Field:	cid	sid	env	dup	spl	Comp	Ambient: Avg
Table:	ESamples	ESamples	ESamples	ESamples	ESamples	Fixedruns	Fixedruns
Total:	Group By	Group By	Group By	Group By	Group By	Group By	Avg
Sort:							
Show:	<input checked="" type="checkbox"/>	<input checked="" type="checkbox"/>	<input checked="" type="checkbox"/>	<input checked="" type="checkbox"/>	<input checked="" type="checkbox"/>	<input checked="" type="checkbox"/>	<input checked="" type="checkbox"/>
Criteria:							
or:							

8.2.2. [CE Ambient cityavg c]

This query calculates city concentration averages for each sample. It can also be used to calculate the city background concentrations. When city averages are calculated, background station must be omitted. Only stations where measurements cover at least 75 % of sampling periods are used in calculation.

Field:	cid	sid	Comp	CityAvg: Avg	n: Avg	Cov	Site
Table:	ESamples	ESamples	Fixedruns	Fixedruns	Fixedruns	Fixedruns	BG stations
Total:	Group By	Group By	Group By	Avg	Count	Where	Where
Sort:							
Show:	<input checked="" type="checkbox"/>	<input checked="" type="checkbox"/>	<input checked="" type="checkbox"/>	<input checked="" type="checkbox"/>	<input checked="" type="checkbox"/>	<input type="checkbox"/>	<input type="checkbox"/>
Criteria:						>='75'	Is Null
or:							

8.2.3. [CE Ambient bgstation c]

This query calculates background station concentrations. Query assumes that background station site codes are listed in the [BGStations] table.

Field:	cid	sid	Comp	CityAvg: Avg	n: Avg	Cov
Table:	ESamples	ESamples	Fixedruns	Fixedruns	Fixedruns	Fixedruns
Total:	Group By	Group By	Group By	Avg	Count	Where
Sort:						
Show:	<input checked="" type="checkbox"/>	<input checked="" type="checkbox"/>	<input checked="" type="checkbox"/>	<input checked="" type="checkbox"/>	<input checked="" type="checkbox"/>	<input type="checkbox"/>
Criteria:						>=75
or:						

Black Smoke in the *EXPOLIS* database

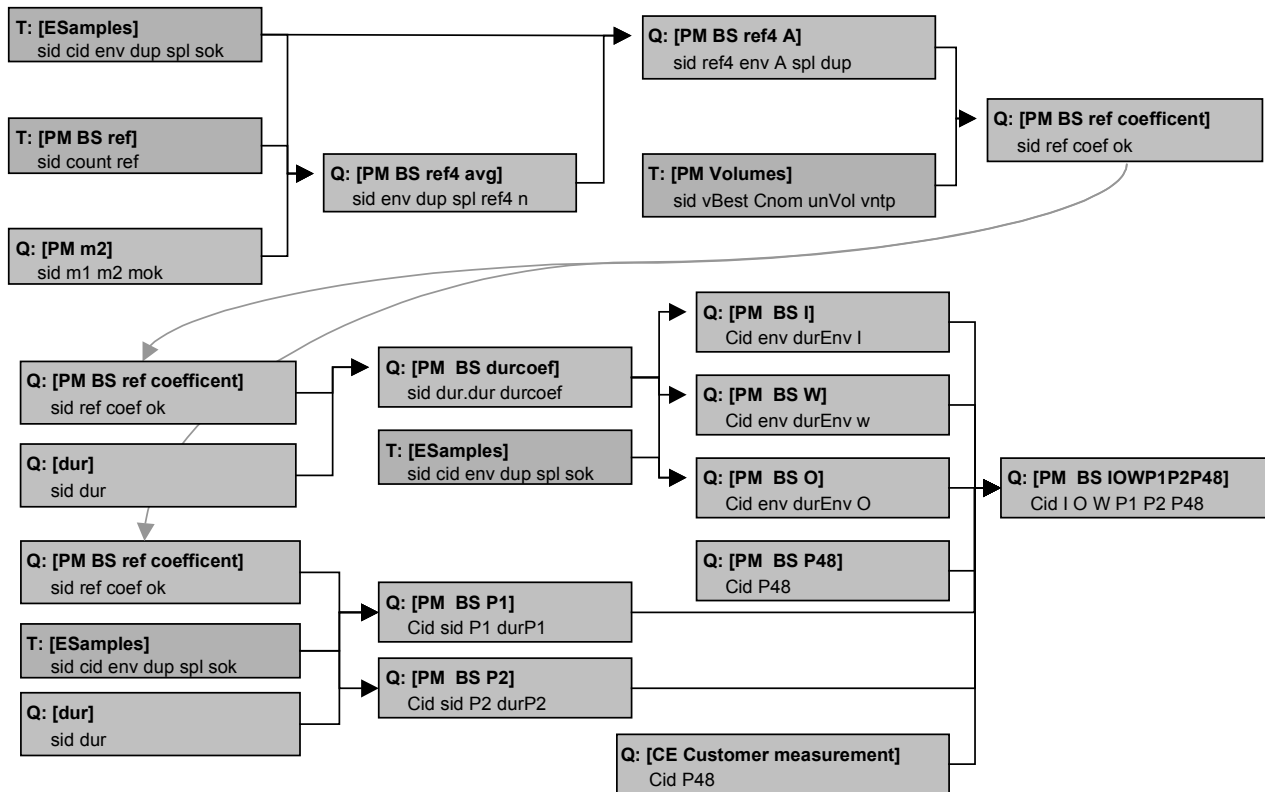

Sari Alm, Jutta Salo and Esa Kaarakainen

KTL Environmental Health
P.O.Box 95
FIN-70701 KUOPIO
FINLAND

Contents

1. INTRODUCTION.....	3
2. TABLES.....	4
2.1 [PM BS REF]	4
2.2 [PM BS RAW].....	4
3. DATA IMPORT AND NORMALIZATION	5
4. QUERIES.....	6
4.1 [PM BS REF A].....	6
4.1.1 [PM BS ref avg]	6
4.2 [PM BS REF4 A].....	7
4.2.1 [PM BS ref4 avg]	7
4.3 [PM BS REF COEFFICIENT].....	8
4.4 [PM BS DURCOEF]	8
4.5 [PM BS I].....	8
4.6 [PM BS O]	9
4.7 [PM BS W]	9
4.8 [PM BS P1]	9
4.9 [PM BS P2]	10
4.10 [PM BS P48]	10
4.11 PM BS IOWP1P2P48	10
5. DATABASE OBJECT LIST	11

1. Introduction

This document describes the Black Smoke queries in the *EXPOLIS* database.

2. Tables

2.1 [PM BS ref]

This table contains measured Black smoke reflectance for each filter in normalized form.

Field Name	Data Type	Description
sid	Number	sample id
count	Number	count of measured reflectances per filter
ref	Number	measured black smoke reflectance of filter

Field Properties	
General	Lookup
Field Size	Long Integer
Format	
Decimal Places	Auto
Input Mask	
Caption	
Default Value	0
Validation Rule	
Validation Text	
Required	No
Indexed	Yes (Duplicates OK)

This property cannot be modified in linked tables.

2.2 [PM BS raw]

This table contains Black smoke data as it was in original Excel file.

Field Name	Data Type	Description
sid	Text	
point 1	Number	
point 2	Number	
point 3	Number	
point 4	Number	
point 5	Number	
average	Number	
Remarks	Text	
Remarks2	Text	
Field15	Text	
Field16	Text	

Field Properties	
General	Lookup
Field Size	255
Format	
Input Mask	
Caption	
Default Value	
Validation Rule	
Validation Text	
Required	No
Allow Zero Length	No
Indexed	Yes (Duplicates OK)

This property cannot be modified in linked tables.

3. Data import and normalization

Original filters were analyzed in Basel and the analyzed data was then sent to Finland in Excel files. For each centre the Excel files were imported into [PM BS raw] table. That table contains all values that were in Excel files, eg. quality checks and control filters.

Normalization of columns into rows was done using 5 queries: [PM BS DC Normalize Point1] – [PM BS DC Normalize Point5]. See picture below.

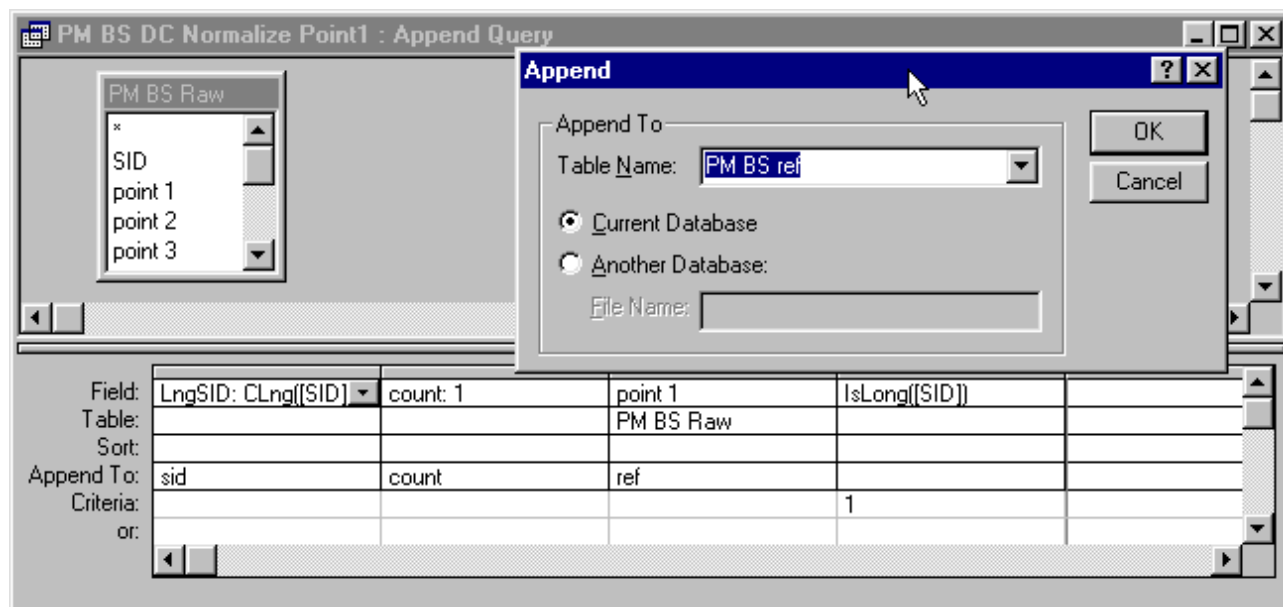

There was one query for each measured reflectance per filter. Value in column *count* is 1-5 depending on the query. The results of the queries were appended into [PM BS ref] table. *IsLong* function in module [PM BS] checks if the sample id is an actual sample and only those values were appended. For example quality checks were marked with *w* after sample id (eg. 412038w) and those values were not added.

```
Public Function IsLong(aStr As String) As Integer
' Checks if a string can be converted to a Long integer
' returns 1 if Yes
' returns 0 if No
' 9.8.2000 eKa

Dim aLong As Long
On Error GoTo Err_IsLong
    aLong = CLng(aStr)
    IsLong = 1

Exit_IsLong:
    Exit Function

Err_IsLong:
    IsLong = 0
    Resume Exit_IsLong
End Function
```

4. Queries

4.1 [PM BS ref A]

The screenshot shows the 'PM BS ref A : Select Query' window. The design grid is as follows:

Field:	sid	avg	env	A: IIf([env]='p';0.0007547676;0.0013202543)	sok	dup
Table:	PM BS ref avg	PM BS ref avg	ESamples		ESamples	ESamples
Sort:						
Show:	<input checked="" type="checkbox"/>	<input checked="" type="checkbox"/>	<input checked="" type="checkbox"/>	<input checked="" type="checkbox"/>	<input type="checkbox"/>	<input type="checkbox"/>
Criteria:					Is Null	1
or:						

4.1.1 [PM BS ref avg]

This query calculates average and standard deviation of reflections for each sample.

The screenshot shows the 'PM BS ref avg : Select Query' window. The design grid is as follows:

Field:	sid	n: ref	avg: ref	std: ref
Table:	PM BS ref	PM BS ref	PM BS ref	PM BS ref
Total:	Group By	Count	Avg	StDev
Sort:				
Show:	<input checked="" type="checkbox"/>	<input checked="" type="checkbox"/>	<input checked="" type="checkbox"/>	<input checked="" type="checkbox"/>
Criteria:				
or:				

4.2 [PM BS ref4 A]

PM BS ref4 A : Select Query

Field:	cid	env	spl	sid: FirstOfsid	ref4	A: IIf([ESamples].[env]='p',0.0007547676,0.0013202543)	dup	sok
Table:	PM BS r	PM BS r	PM BS	PM BS ref4 avg	PM BS ref4 avg		PM BS ref4 avg	ESamples
Sort:								
Show:	<input checked="" type="checkbox"/>	<input checked="" type="checkbox"/>	<input checked="" type="checkbox"/>	<input checked="" type="checkbox"/>	<input checked="" type="checkbox"/>	<input checked="" type="checkbox"/>	<input checked="" type="checkbox"/>	<input checked="" type="checkbox"/>
Criteria:								Is Null Or <>3
or:								

4.2.1 [PM BS ref4 avg]

PM BS ref4 avg : Select Query

Field:	cid	env	dup	spl: yjoint([ESamples].[spl])	sid	ref4: ref	n: sid	mok: mok
Table:	ESamples	ESamples	ESamples		PM BS ref	PM BS ref	PM BS ref	PM m2
Total:	Group By	Group By	Group By	Group By	First	Avg	Count	Max
Sort:	Ascending	Ascending						
Show:	<input checked="" type="checkbox"/>	<input checked="" type="checkbox"/>	<input checked="" type="checkbox"/>	<input checked="" type="checkbox"/>	<input checked="" type="checkbox"/>	<input checked="" type="checkbox"/>	<input checked="" type="checkbox"/>	<input checked="" type="checkbox"/>
Criteria:								
or:								

```

Public Function yjoint(spl)

If spl = 9 Then yjoint = 8 Else yjoint = spl

End Function
    
```

4.3 [PM BS ref coefficient]

The screenshot shows a query window with two tables: 'PM BS ref4 A' and 'PM Volumes'. The 'PM BS ref4 A' table contains fields: sid, ref4, env, spl, A, dup, sok. The 'PM Volumes' table contains fields: sid, dur.dur, Vnom, Vt, ok, vbest, unVol. Below the diagram is a table grid:

Field:	sid	ref4	coef: If([spl]="8",(((A)/Vbest))*Log(100/[ref4])),((A)/(2*Vbest))*Log(100/[ref4]))	ok	sok	spl
Table:	PM BS ref4 A	PM BS ref4 A		PM Volumes	PM BS ref4 A	PM BS ref4 A
Sort:	Ascending					
Show:	<input checked="" type="checkbox"/>	<input checked="" type="checkbox"/>		<input checked="" type="checkbox"/>	<input checked="" type="checkbox"/>	<input checked="" type="checkbox"/>
Criteria:				<>3	Is Null Or <>3	
or:						

Milan: Vnom was used instead of Vbest
 Grenoble: Vpem was used instead of Vbest and spl=6

4.4 [PM BS durcoef]

The screenshot shows a query window with two tables: 'PM BS ref coefficient' and 'Dur'. The 'PM BS ref coefficient' table contains fields: sid, ref4, coef, ok, spl. The 'Dur' table contains fields: sid, dur, nstart, MaxOfrok. Below the diagram is a table grid:

Field:	sid	dur	durcoef: [coef]*[dur]
Table:	PM BS ref coefficient	Dur	
Sort:			
Show:	<input checked="" type="checkbox"/>	<input checked="" type="checkbox"/>	<input checked="" type="checkbox"/>
Criteria:			
or:			

4.5 [PM BS I]

The screenshot shows a query window with two tables: 'PM BS durcoef' and 'ESamples'. The 'PM BS durcoef' table contains fields: sid, dur.dur, durcoef. The 'ESamples' table contains fields: sid, cid, env, dup. Below the diagram is a table grid:

Field:	cid	env	durEnv: dur.dur	sumEcoef: durcoef	I: [sumEcoef]/[durEnv]	n: sid	dup	spl
Table:	ESamples	ESamples	PM BS durcoef	PM BS durcoef	Expression	PM BS durcoef	ESamples	ESamples
Total:	Group By	Group By	Sum	Sum		Count	Where	Where
Sort:								
Show:	<input checked="" type="checkbox"/>	<input checked="" type="checkbox"/>	<input checked="" type="checkbox"/>	<input checked="" type="checkbox"/>	<input checked="" type="checkbox"/>	<input checked="" type="checkbox"/>	<input type="checkbox"/>	<input type="checkbox"/>
Criteria:		"1"					1	>="1" And <="9"
or:								

4.6 [PM BS O]

The screenshot shows a query design grid with two tables: 'PM BS durcoef' and 'ESamples'. The 'PM BS durcoef' table has fields 'sid', 'dur.dur', and 'durcoef'. The 'ESamples' table has fields 'sid', 'cid', 'env', and 'dup'. Below the grid is a table with the following data:

Field:	cid	env	durEnv: dur.dur	sumEcoef: durcoef	O: [sumEcoef]/[durEnv]	n: sid	dup	spl
Table:	ESamples	ESamples	PM BS durcoef	PM BS durcoef	Expression	PM BS durcoef	ESamples	ESamples
Total:	Group By	Group By	Sum	Sum	Expression	Count	Where	Where
Sort:								
Show:	<input checked="" type="checkbox"/>	<input checked="" type="checkbox"/>	<input checked="" type="checkbox"/>	<input checked="" type="checkbox"/>	<input checked="" type="checkbox"/>	<input checked="" type="checkbox"/>	<input type="checkbox"/>	<input type="checkbox"/>
Criteria:		"0"					1	>="1" And <="9"
or:								

4.7 [PM BS W]

The screenshot shows a query design grid with two tables: 'PM BS durcoef' and 'ESamples'. The 'PM BS durcoef' table has fields 'sid', 'dur.dur', and 'durcoef'. The 'ESamples' table has fields 'sid', 'cid', 'env', and 'dup'. Below the grid is a table with the following data:

Field:	cid	env	durEnv: dur.dur	sumEcoef: durcoef	W: [sumEcoef]/[durEnv]	n: sid	dup	spl
Table:	ESamples	ESamples	PM BS durcoef	PM BS durcoef	Expression	PM BS durcoef	ESamples	ESamples
Total:	Group By	Group By	Sum	Sum	Expression	Count	Where	Where
Sort:								
Show:	<input checked="" type="checkbox"/>	<input checked="" type="checkbox"/>	<input checked="" type="checkbox"/>	<input checked="" type="checkbox"/>	<input checked="" type="checkbox"/>	<input checked="" type="checkbox"/>	<input type="checkbox"/>	<input type="checkbox"/>
Criteria:		"W"					1	>="1" And <="9"
or:								

4.8 [PM BS P1]

The screenshot shows a query design grid with three tables: 'PM BS ref coefficient', 'ESamples', and 'Dur'. The 'PM BS ref coefficient' table has fields 'sid', 'ref4', 'coef', 'ok', and 'spl'. The 'ESamples' table has fields 'sid', 'cid', 'env', 'dup', 'spl', 'sok', and 'comment'. The 'Dur' table has fields 'sid', 'dur', 'nstart', and 'MaxOfrok'. Below the grid is a table with the following data:

Field:	cid	sid	P1: coef	durP1: dur	env	sok	dup	spl
Table:	ESamples	PM BS ref coefficient	PM BS ref coefficient	Dur	ESamples	ESamples	ESamples	ESamples
Sort:	Ascending							
Show:	<input checked="" type="checkbox"/>	<input checked="" type="checkbox"/>	<input checked="" type="checkbox"/>	<input checked="" type="checkbox"/>	<input type="checkbox"/>	<input type="checkbox"/>	<input type="checkbox"/>	<input type="checkbox"/>
Criteria:					"P"	Is Null Or <>3	1	"1"
or:								

4.9 [PM BS P2]

Field:	cid	sid	P2: coef	durP2: dur	env	sok	dup	spl
Table:	ESamples	PM BS ref coefficient	PM BS ref coefficient	Dur	ESamples	ESamples	ESamples	ESamples
Sort:	Ascending							
Show:	<input checked="" type="checkbox"/>	<input checked="" type="checkbox"/>	<input checked="" type="checkbox"/>	<input checked="" type="checkbox"/>	<input type="checkbox"/>	<input type="checkbox"/>	<input type="checkbox"/>	<input type="checkbox"/>
Criteria:					"P"	Is Null Or <>3	1	"2"
or:								

4.10 [PM BS P48]

Field:	cid	
Table:	CE Customer measurements	P48: Ifr(((PM BS P1).[cid] Is Null) Or ((PM BS P2).[cid] Is Null):-9,((P1)*[durP1]+[P2]*[durP2])/([durP1]+[durP2]))
Sort:	Ascending	
Show:	<input checked="" type="checkbox"/>	<input checked="" type="checkbox"/>
Criteria:		
or:		

4.11 PM BS IOWP1P2P48

Field:	cid	I	O	W	P1	P2	P48
Table:	CE Customer meas.	PM BS I	PM BS O	PM BS W	PM BS P1	PM BS P2	PM BS P48
Sort:							
Show:	<input checked="" type="checkbox"/>	<input checked="" type="checkbox"/>	<input checked="" type="checkbox"/>	<input checked="" type="checkbox"/>	<input checked="" type="checkbox"/>	<input checked="" type="checkbox"/>	<input checked="" type="checkbox"/>
Criteria:							
or:							

5. Database object list

Here is a list of database objects that were created for Black smoke analysis:

Tables:

- [PM BS raw]
- [PM BS ref]

Queries:

- [PM BS DC Normalize Point1]
- [PM BS DC Normalize Point2]
- [PM BS DC Normalize Point3]
- [PM BS DC Normalize Point4]
- [PM BS DC Normalize Point5]
- [PM BS ref A]
- [PM BS ref avg]
- [PM BS ref4 A]
- [PM BS ref4 avg]
- [PM BS ref coefficient]
- [PM BS durcoef]
- [PM BS durcoef]
- [PM BS I]
- [PM BS O]
- [PM BS W]
- [PM BS P1]
- [PM BS P2]
- [PM BS P48]
- [PM BS IOWP1P2P48]

Module:

- [PM BS]

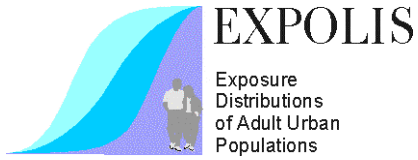

ESA KAARAKAINEN

8.1.2001 (+Oxford 23.5.2002)

EAS CQN.doc

Documentation of the Concentration Query Network EAS

How to Calculate EAS Concentrations From the *EXPOLIS* Database

Sari Alm, Esa Kaarakainen and Otto Hänninen

KTL Environmental Health
P.O.Box 95
FIN-70701 KUOPIO
FINLAND

CONTENTS

1. EAS TABLES	3
1.1 [EAS BLANK CORRECTION].....	3
1.2 [EAS COMPOUNDS]	3
1.3 [EAS MASSES]	3
2. EAS CONCENTRATION QUERIES	4
2.1 [EAS BMASSES].....	4
2.2 [EAS NGM4].....	4
2.3 [EAS C].....	5
2.4 [EAS NG SUMOFMEM].....	5
2.5 [EAS C4 MEM].....	5
2.6 [EAS C I].....	6
2.7 EAS C O	6
2.8 EAS C W	6
2.9 EAS C P1	7
2.10 EAS C P2.....	7
2.11 EAS C P48.....	7
2.12 OTHER QUERIES	8
2.13 OXFORD MODIFICATION	9

1. EAS TABLES

1.1 [EAS blank correction]

EAS blank correction : Table

Field Name	Data Type	Description
element	Text	name of the element
beasMEM	Number	blank correction of the elemental level of MEMs
beasPEM	Number	blank correction of the elemental level of PEMs

Field Properties

General | Lookup

Field Size	50
Format	
Input Mask	
Caption	
Default Value	
Validation Rule	
Validation Text	
Required	No
Allow Zero Length	No
Indexed	No

This property cannot be modified in linked tables.

1.2 [EAS compounds]

EAS compounds : Table

Field Name	Data Type	Description
el_num	Number	number of the element
element	Text	name of the element

Field Properties

General | Lookup

Field Size	Byte
Format	
Decimal Places	Auto
Input Mask	
Caption	
Default Value	
Validation Rule	
Validation Text	
Required	No
Indexed	Yes (No Duplicates)

This property cannot be modified in linked tables.

1.3 [EAS Masses]

EAS masses : Table

Field Name	Data Type	Description
sid	Number	Expolis sample number
el_num	Number	number of the element
position	Number	Position of the sample on the sampler changer
ng_cm2	Number	mass of the element per cm2
EAS_DL	Number	1="correct value" 2=half of the detection limit has been used

Field Properties

General | Lookup

Field Size	Long Integer
Format	
Decimal Places	Auto
Input Mask	
Caption	
Default Value	
Validation Rule	
Validation Text	
Required	Yes
Indexed	No

This property cannot be modified in linked tables.

2. EAS concentration queries

2.1 [EAS bmasses]

Note: this query was modified for Oxford (see Oxford chapter in this document).

EAS field blank correction criteria: The geometric mean of all blanks (GMAll) has been calculated and compared that to 2*geometric mean of all blanks below detection limit (GMBelow). If the GMAll is higher or equal than GMBelow the blank subtraction (=GMAll) will be use. If there were no GMBelow values for that element GMAll has been used. The subtraction will only be made to those samples which are above detection limit (DL=1).

2.2 [EAS ngm4]

```
Public Function EASyjoint(spl)
' Modified 9.10.2000 by Esa Kaarakainen
' Copy from yjoint function but Added "" to if -clause,
' [EAS yjoint] query does not work without them. Access expects to receive
' spl as number, with "" spl is hanled as string.
```

```
If spl = "9" Then EASyjoint = "8" Else EASyjoint = spl
```

```
End Function
```

2.3 [EAS c]

The screenshot shows a query window titled "EAS c : Select Query". It contains a diagram with four tables: "PM m4", "EAS compounds", "EAS ngm4", and "PM Volumes". Arrows indicate relationships between these tables. Below the diagram is a table with the following columns: Field, Table, Sort, Show, Criteria, and or. The table contains the following data:

Field	Table	Sort	Show	Criteria	or
sid	EAS		<input checked="" type="checkbox"/>		
element	EAS con		<input checked="" type="checkbox"/>		
ng				ng: If([EAS ngm4].[env]='P',[ngm4]*7.54767635,[ngm4]*13.20254313)	
EAS c				[ng]/[Vbest]	
EAS massc				[ng]/[m4]	
position				EAS ngr	
EAS DL				EAS ngm4	
sok					Is Null Or <>

Note: this query was modified for Oxford (see Oxford chapter in this document).

2.4 [EAS ng SumOfMEM]

The screenshot shows a query window titled "EAS ng SumOfMEM : Select Query". It contains a diagram with two tables: "ESamples" and "EAS c". Below the diagram is a table with the following columns: Field, Table, Total, Group By, Sort, Show, Criteria, and or. The table contains the following data:

Field	Table	Total	Group By	Sort	Show	Criteria	or
cid	ESamples	Group By			<input checked="" type="checkbox"/>		
env	ESamples	Group By			<input checked="" type="checkbox"/>		
element	EAS c	Group By			<input checked="" type="checkbox"/>		
ng	EAS c	First			<input checked="" type="checkbox"/>		
ng	EAS c	Last			<input checked="" type="checkbox"/>		
ng	EAS c	Sum			<input checked="" type="checkbox"/>		
n	EAS c	Count			<input checked="" type="checkbox"/>		
sok		Expression			<input checked="" type="checkbox"/>		
ng		Where				<>-9	
env		Where				<>'P'	
dup		Where				1	
spl		Where				>='1' And <='9'	

2.5 [EAS c4 MEM]

The screenshot shows a query window titled "EAS c4 MEM : Select Query". It contains a diagram with four tables: "CE Customer measurements", "EAS ng SumOfMEM", "PM m4 SumOfMEM", and "PM Volumes SumOfMEM". Below the diagram is a table with the following columns: Field, Table, Sort, Show, Criteria, and or. The table contains the following data:

Field	Table	Sort	Show	Criteria	or
cid	CE		<input checked="" type="checkbox"/>		
ele	EA		<input checked="" type="checkbox"/>		
env	EA		<input checked="" type="checkbox"/>		
nmEAS	EAS ng S		<input checked="" type="checkbox"/>		
nV	PM V		<input checked="" type="checkbox"/>		
nm4	PM m4		<input checked="" type="checkbox"/>		
EAS_cMEM				If([nmEAS]=1 And [nV]=2..9,[ng]/[Vbest])	
EAS_masscMEM				If([nmEAS]=1 And [nm4]=2..9,[ng]/[m4])	
sok					Is Null Or <>

2.6 [EAS c I]

Field:	cid	element	I_EASc: EAS_cMEM	I_EASmassc: EAS_masscMEM	env		
Table:	CE Customer measurements	EAS c4 MEM	EAS c4 MEM	EAS c4 MEM	EAS c4 MEM		
Sort:	Ascending	Ascending					
Show:	<input checked="" type="checkbox"/>	<input checked="" type="checkbox"/>	<input checked="" type="checkbox"/>	<input checked="" type="checkbox"/>	<input checked="" type="checkbox"/>	<input type="checkbox"/>	<input type="checkbox"/>
Criteria:						"I"	
or:							

2.7 EAS c O

Field:	cid	element	O_EASc: EAS_cMEM	O_EASmassc: EAS_masscMEM	env		
Table:	CE Customer measurements	EAS c4 MEM	EAS c4 MEM	EAS c4 MEM	EAS c4 MEM		
Sort:	Ascending	Ascending					
Show:	<input checked="" type="checkbox"/>	<input checked="" type="checkbox"/>	<input checked="" type="checkbox"/>	<input checked="" type="checkbox"/>	<input checked="" type="checkbox"/>	<input type="checkbox"/>	<input type="checkbox"/>
Criteria:						"O"	
or:							

2.8 EAS c W

Field:	cid	element	W_EASc: EAS_cMEM	W_EASmassc: EAS_masscMEM	env		
Table:	CE Customer measurements	EAS c4 MEM	EAS c4 MEM	EAS c4 MEM	EAS c4 MEM		
Sort:	Ascending	Ascending					
Show:	<input checked="" type="checkbox"/>	<input checked="" type="checkbox"/>	<input checked="" type="checkbox"/>	<input checked="" type="checkbox"/>	<input checked="" type="checkbox"/>	<input type="checkbox"/>	<input type="checkbox"/>
Criteria:						"W"	
or:							

2.9 EAS c P1

Field:	cic	sid	elemen	P1_EASc: EAS_c	P1_EASmassc: EAS_massc	env	spl	dup	sok	mok	ok	durP1: dur
Table:	ES	ES	EAS c	EAS c	EAS c	ESamples	ESa	ESam	ESamples	EAS c	EAS c	Dur
Sort:												
Show:	<input checked="" type="checkbox"/>	<input checked="" type="checkbox"/>	<input checked="" type="checkbox"/>	<input checked="" type="checkbox"/>	<input checked="" type="checkbox"/>	<input checked="" type="checkbox"/>	<input checked="" type="checkbox"/>	<input checked="" type="checkbox"/>	<input checked="" type="checkbox"/>	<input checked="" type="checkbox"/>	<input checked="" type="checkbox"/>	<input checked="" type="checkbox"/>
Criteria:						"P"	"1"	1	Is Null Or <>3	Is Null Or <>3	Is Null Or <>3	
or:												

2.10 EAS c P2

Field:	cid	sid	elemen	P2_EASc: EAS_c	P2_EASmassc: EAS_massc	env	spl	dup	sok	mok	ok	durP2: dur
Table:	ES	ES	EAS c	EAS c	EAS c	ESa	ESa	ESa	ESamples	EAS c	EAS c	Dur
Sort:												
Show:	<input checked="" type="checkbox"/>	<input checked="" type="checkbox"/>	<input checked="" type="checkbox"/>	<input checked="" type="checkbox"/>	<input checked="" type="checkbox"/>	<input checked="" type="checkbox"/>	<input checked="" type="checkbox"/>	<input checked="" type="checkbox"/>	<input checked="" type="checkbox"/>	<input checked="" type="checkbox"/>	<input checked="" type="checkbox"/>	<input checked="" type="checkbox"/>
Criteria:						"P"	"2"	1	Is Null Or <>3	Is Null Or <>3	Is Null Or <>3	
or:												

2.11 EAS c P48

Field:	cid	element	P48_EASc: ((P1_EASc)*[durP1]+[P2_EASc]*[durP2])/([durP1]+[durP2])	P48_EASmassc: ((P1_EASmassc)*[durP1]+[P2_EASmassc]*[durP2])/([durP1]+[durP2])	env
Table:	EAS	EAS c f			EAS c l
Sort:					
Show:	<input checked="" type="checkbox"/>	<input checked="" type="checkbox"/>	<input checked="" type="checkbox"/>	<input checked="" type="checkbox"/>	<input checked="" type="checkbox"/>
Criteria:					
or:					

2.12 Other queries

Following queries were also used but not included in this document:

- PM m4 SumOfMEM
- PM Volumes Sum of MEM
- CE Customer measurements
- PM Volumes
- PM m4

See CQN PM2.5 documentation for closer details.

2.13 Oxford modifications (23.5.2002)

The EAS queries were modified 23.5.2002 for Oxford data to take into account the fact that in Oxford 37 mm filters were used in all other microenvironments but home outdoors.

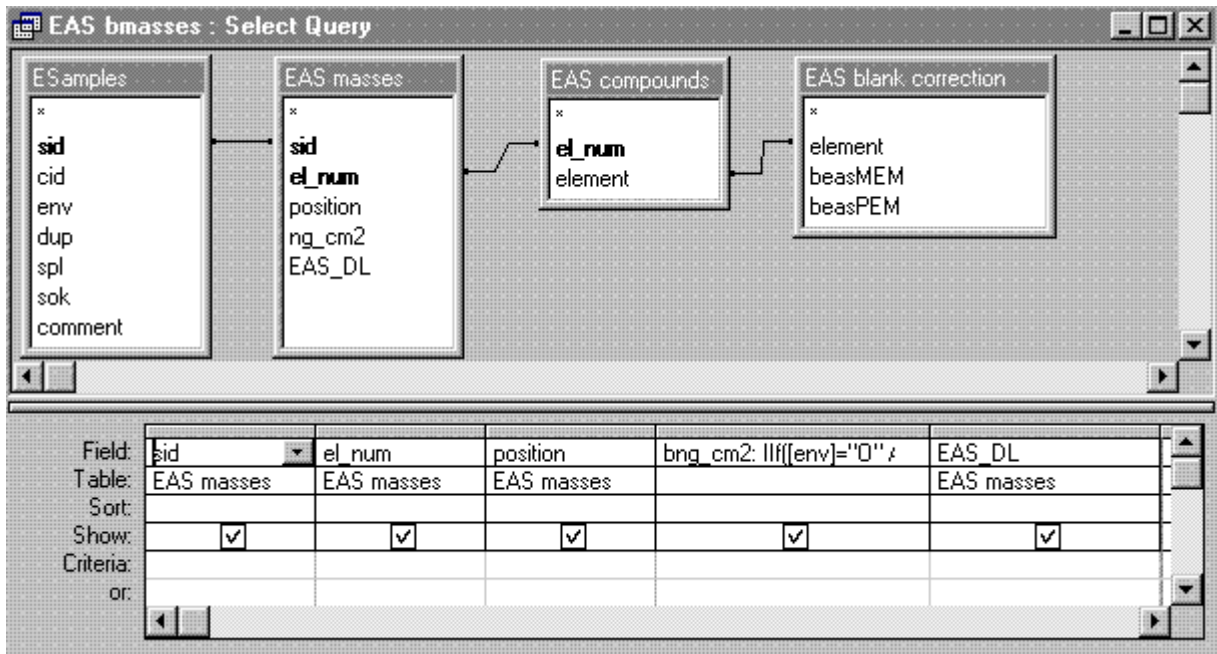

Equations:

Original

bng_cm2: IIf([env]="P" And [EAS_DL]=1,[ng_cm2]-[beasPEM], IIf(([env]="I" Or [env]="O" Or [env]="W") And [EAS_DL]=1,[ng_cm2]-[beasMEM],[ng_cm2]))

Modified

bng_cm2: IIf([env]="O" And [EAS_DL]=1,[ng_cm2]-[beasMEM],IIf(([env]="I" Or [env]="P" Or [env]="W") And [EAS_DL]=1,[ng_cm2]-[beasPEM],[ng_cm2]))

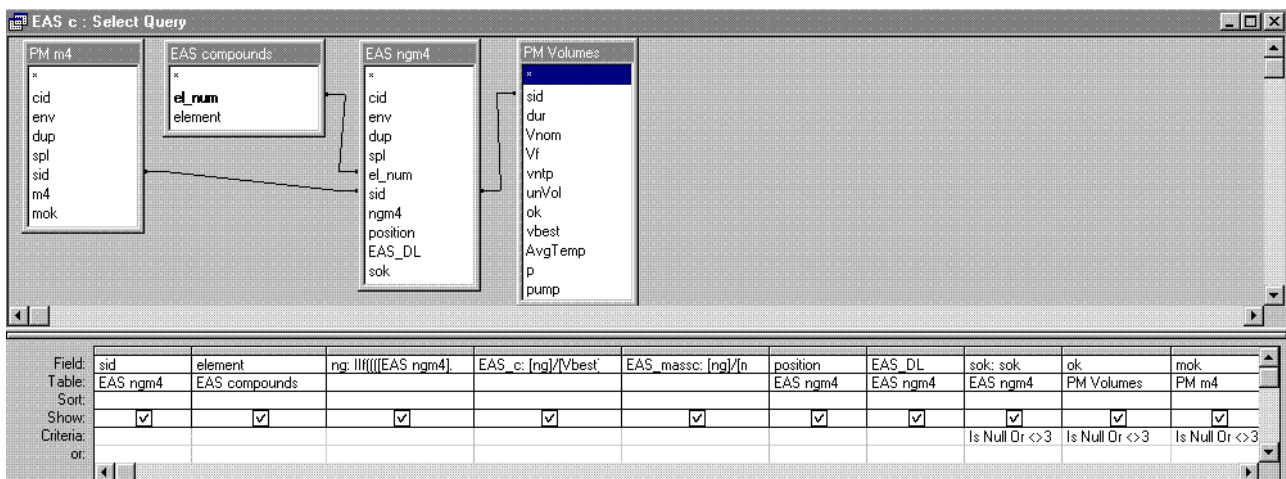

Equations:

Original

ng: IIf([EAS ngm4].[env]="P"),[ngm4]*7.54767635,[ngm4]*13.20254313)

EAS_c: [ng]/[Vbest]

EAS_massc: [ng]/[m4]

Modified

ng: IIf([EAS ngm4].[env]<"O"),[ngm4]*7.54767635,[ngm4]*13.20254313)

Creating the Combined International *EXPOLIS* Database (CIDB)

This document describes how the Final Expolis Database was created.

Esa Kaarakainen

KTL Environmental Health
P.O.Box 95
FIN-70701 KUOPIO
FINLAND

Contents

CONTENTS	2
TABLES	3
1.1 MAKE TABLE QUERIES.....	3
1.2 EAS TABLES.....	3
1.3 FUNCTIONS IN [EASCREATE] MODULE:.....	3
2. APPEND QUERIES IN EADBTOOL(S)	5
2.1 [FDB CUSTOMERS TO EADB].....	5
2.2 [FDB DUR TO EADB].....	6
2.3 [FDB EQ48HR TO EADB] IN HELSINKI.....	6
2.3.1 [FDB EQ48hr] in Helsinki.....	6
2.4 [FDB EQ48HR TO EADB] IN BASEL.....	7
2.5 [FDB EQLONG TO EXPOLISDB] IN HELSINKI.....	7
2.5.1 [FDB EQLong] in Helsinki.....	7
2.6 [FDB EQLONG TO EXPOLISDB] IN BASEL.....	8
2.7 [FDB ERUNS TO EADB].....	8
2.7.1 Helsinki.....	8
2.7.2 Other centres.....	8
2.8 [FDB ESAMPLES TO EADB].....	9
2.8.1 Helsinki.....	9
2.8.2 Other centres.....	9
2.9 [FDB NO2 c TO EADB].....	10
2.10 [FDB NO2 c IOPW TO EADB].....	10
2.11 [FDB P SHORT Q TO EXPOLISDB] IN HELSINKI.....	11
2.11.1 [FDB P Short Q] in Helsinki.....	11
2.12 [FDB P SHORT Q TO EXPOLISDB] IN BASEL.....	12
2.13 PM QUERIES AND MODULES.....	13
2.13.1 Module [ExpolisPMStd].....	13
2.13.2 [FDB PM c to EADB].....	13
2.13.3 [FDB PM c P1P2P48IOW To ExpolisDB].....	14
2.14 [FDB VOC LOD c TO EADB].....	14
2.14.1 Helsinki.....	14
2.14.2 Basel.....	15
2.15 [FDB VOC LOD c I TO EADB].....	15
2.15.1 [FDB VOC lod c I To EADB sub].....	16
2.16 [FDB VOC LOD c O TO EADB].....	16
2.16.1 [FDB VOC lod c O To EADB sub].....	16
2.17 [FDB VOC LOD c P TO EADB].....	17
2.17.1 [FDB VOC lod c P To EADB sub].....	17
2.18 [FDB VOC LOD c W TO EADB].....	18
2.18.1 [FDB VOC lod c W To EADB sub].....	18
2.19 [FDB VOC COMPOUNDS TO EADB], ONLY IN HELSINKI.....	18
2.20 [FDB FIXEDRUNS TO EADB].....	19
2.21 APPENDING BLACK SMOKE DATA.....	19
2.21.1 [FDB PM BS to EADB].....	19
2.21.2 [FDB PM BS IOWP1P2P48].....	19
3. APPENDING EAS DATA	20
4. APPEND QUERIES IN TMAD15MINTOOL	21
4.1 FDB CID MINUTE TOTALS TO EADB.....	21
4.2 [FDB CO c TO EADB].....	21
APPENDIX A: [EASMODULE]	22
APPENDIX B: MODULE [EADBCOPY]	26

Tables

1.1 Make table queries

All tables except EAS-tables in the Final Database were created using *make table* queries. After each query was run once the type of the query was changed to *append query*. Picture below shows one example of make table query. All other queries described in this document are append queries.

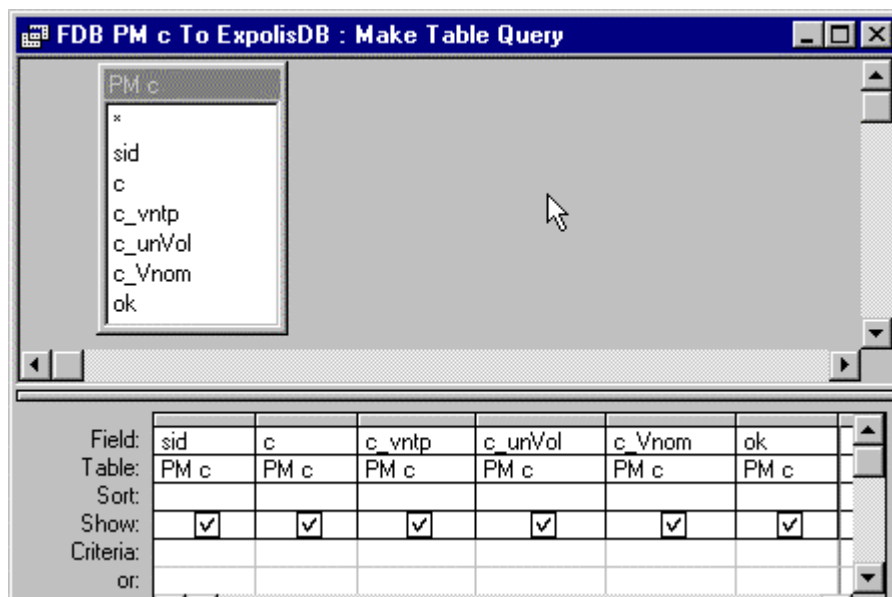

1.2 EAS tables

EAS-tables (18) were created using three functions in [EASCreate] module. Main function is *CrtEASTables* which users two other functions.

Table [EAS Compounds] was copied from Helsinki.mdb.

1.3 Functions in [EASCreate] module:

```

-----
Public Function CrtEASTables()
' Creates EAS tables
' 26.1.2000 eKa

Dim envs As Variant
Dim cTypes As Variant
Dim e As Variant, c As Variant
envs = Array("I", "O", "W", "P1", "P2", "P48")
cTypes = Array("c", "massc", "DL")

For Each c In cTypes
  Debug.Print c
  For Each e In envs
    Debug.Print e;
    CrtTable c, e
    altEastbl c, e
  Next e
  Debug.Print
Next c
End Function

-----
Public Function CrtTable(cType, env)
' Creates EAS-table with only one field: cid

```

```
' 26.1.2000 eKa

Dim aStr As String
Dim db As DATABASE
Set db = CurrentDb
    aStr = "CREATE TABLE [EAS " & cType & " " & env & "] (cid LONG);"
    Debug.Print aStr
    db.Execute aStr
End Function

-----
Public Function altEasTbl(cType, env)
' adds columns for each [EAS compounds] to EAS tables
' param: cType -> concentration type (c, massc, DL) -> declared in
CrteEAStables
'         env -> environment (I, O, W, P1, P2, P48)-> declared in
CrteEAStables
' 26.1.2000 eKa

Dim db As DATABASE
Dim tbl As TableDef
Dim aRst As recordset
Dim aStr As String
Dim aTblname As String
Dim el As String
Set db = CurrentDb
Set aRst = db.OpenRecordset("EAS compounds", dbOpenTable)

aTblname = "EAS " & cType & " " & env 'name of the table to alter
Debug.Print aTblname
    aRst.MoveFirst
        While Not aRst.EOF
            el = aRst.Fields("element").Value
            aStr = "ALTER TABLE [" & aTblname & "] ADD COLUMN " & cType &
env & "_" & el & " double;"
            Debug.Print aStr
            db.Execute aStr
            aRst.MoveNext
        Wend
End Function

-----
```

2. Append queries in EADBTOOL(S)

Here are the append queries in EADBTOOL database. Some queries are slightly different in Helsinki EADBTOOL compared to other centres EADBTOOL.

2.1 [FDB Customers to EADB]

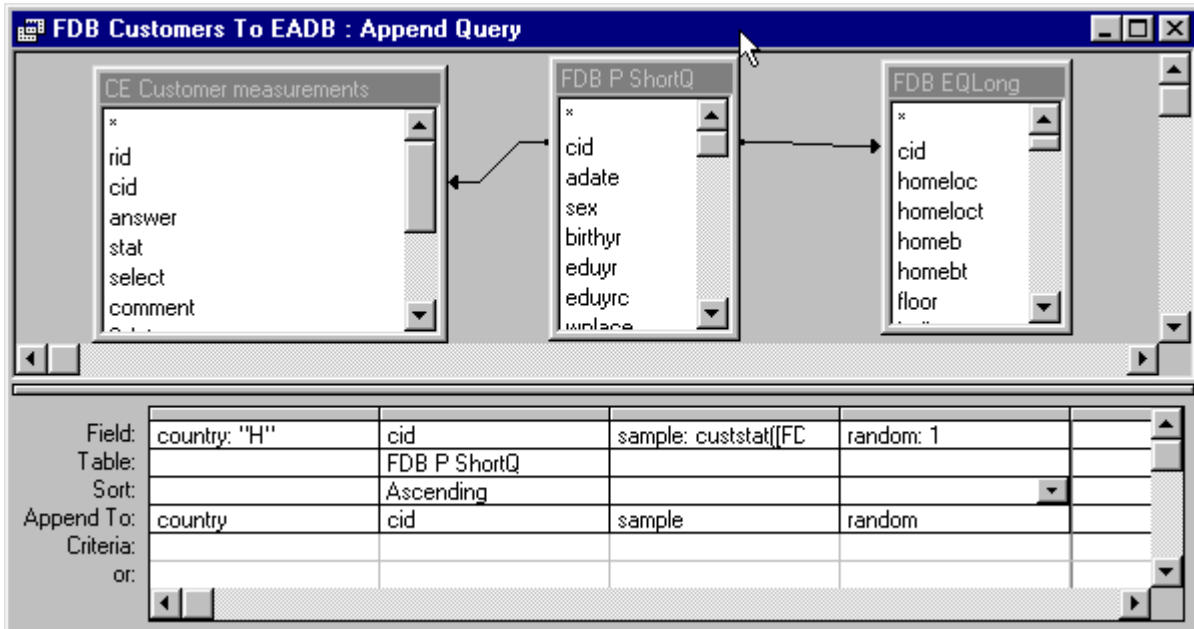

Field random: 1=random and 2= not random. In Helsinki all except some are random. For non random customers value of the random field was changed manually to 2.

Athens random = 1

Basel random = 1

Grenoble random = 2

Milan random: IIf([sample]="exposure";2;1)

Prague random = 1

Function custStat in module [ExpolisPMStd]

```
Public Function custStat(cidTmad As Variant, cidExp As Variant) As String

If (IsNull(cidTmad)) = True And (IsNull(cidExp)) = True Then
    custStat = "Base"

Else
    If (IsNull(cidExp)) = True And (IsNull(cidTmad)) = False Then
        custStat = "Diary"
    Else
        If (IsNull(cidExp)) = False And (IsNull(cidTmad)) = False Then
            custStat = "Exposure"
        Else
            custStat = "JIPIIIII"
        End If
    End If
End If
End Function
```

2.2 [FDB Dur To EADB]

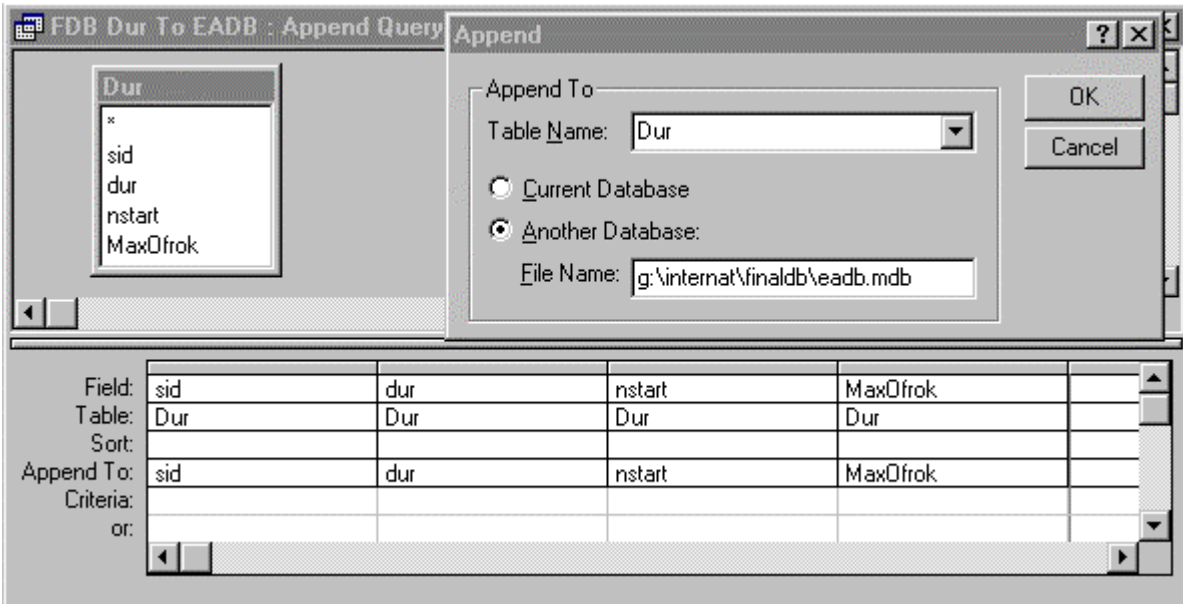

2.3 [FDB EQ48hr to EADB] in Helsinki

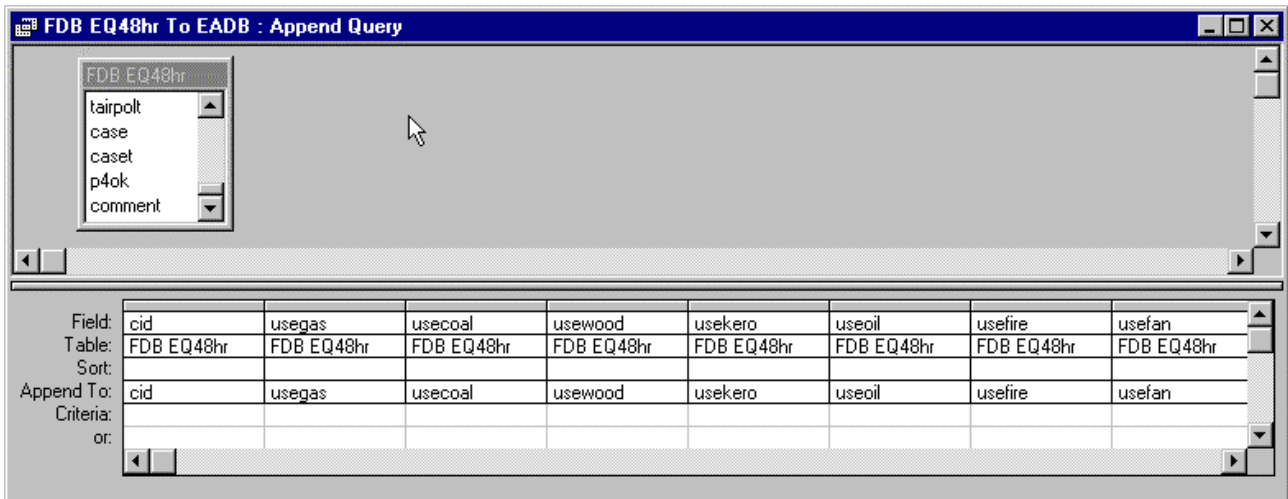

2.3.1 [FDB EQ48hr] in Helsinki

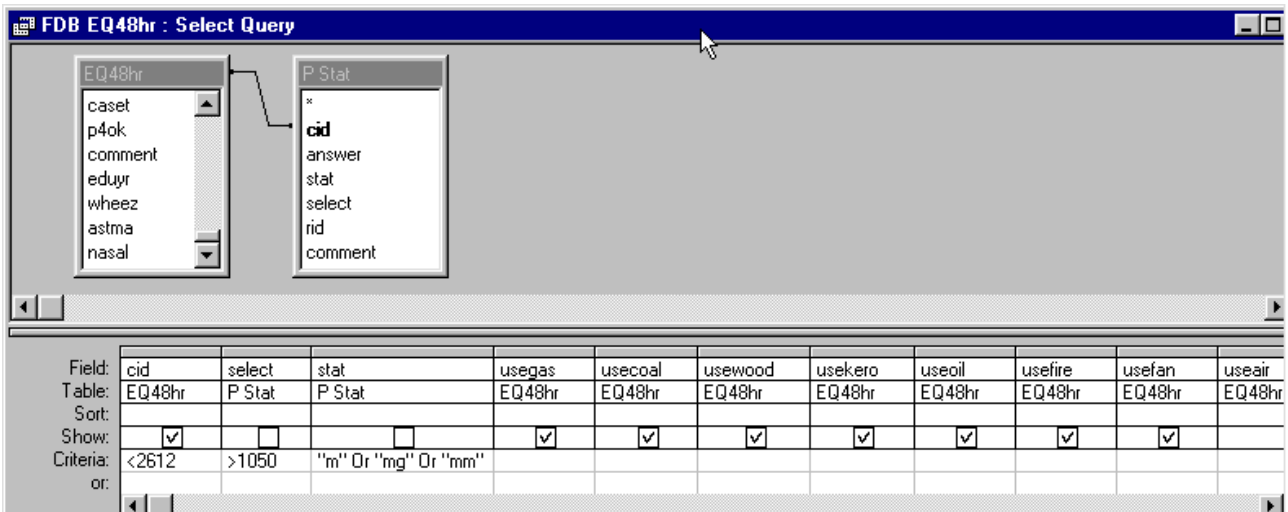

2.4 [FDB EQ48hr to EADB] in Basel

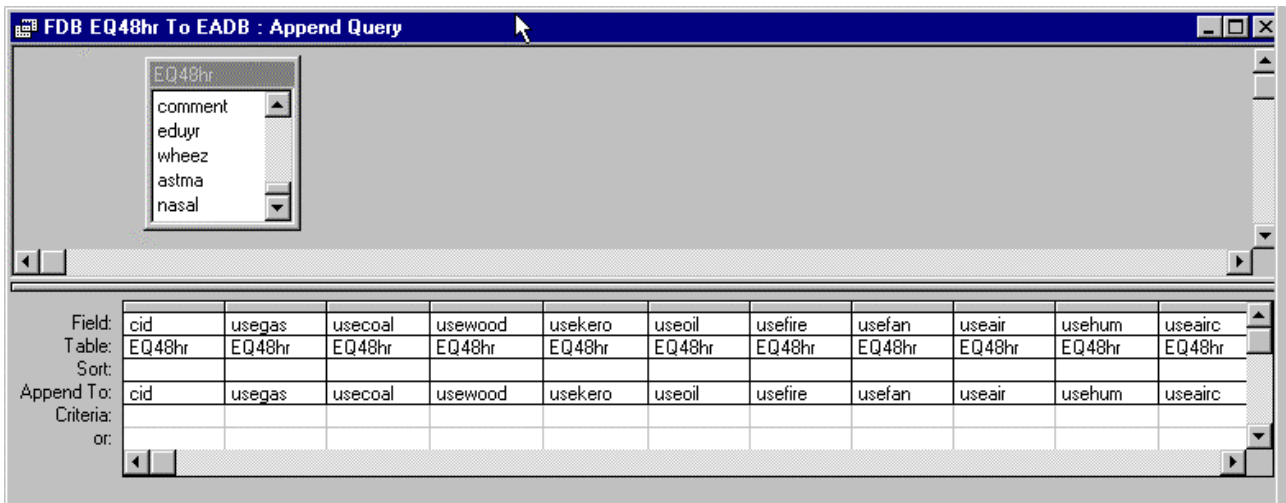

2.5 [FDB EQLong To ExpolisDB] in Helsinki

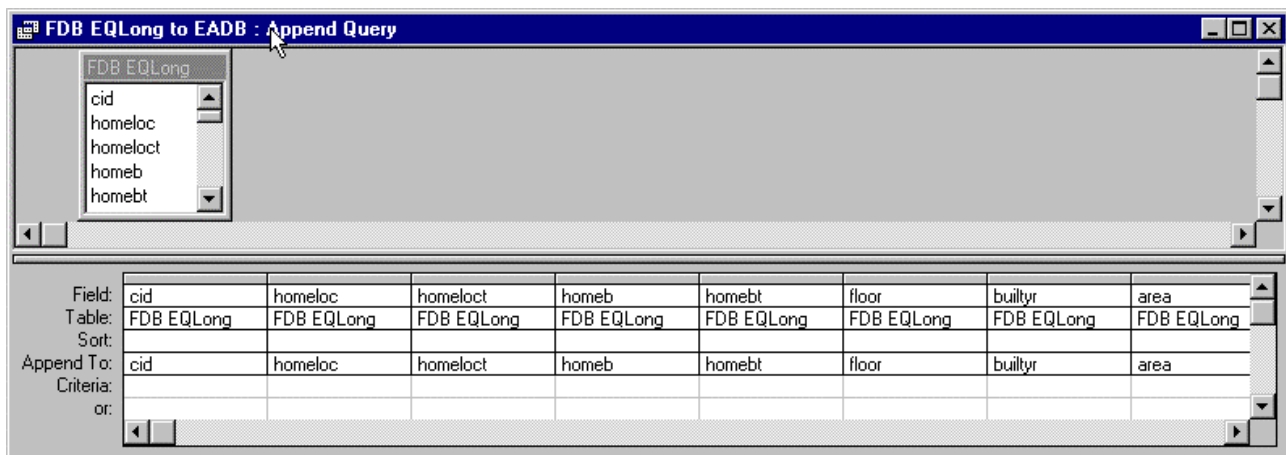

2.5.1 [FDB EQLong] in Helsinki

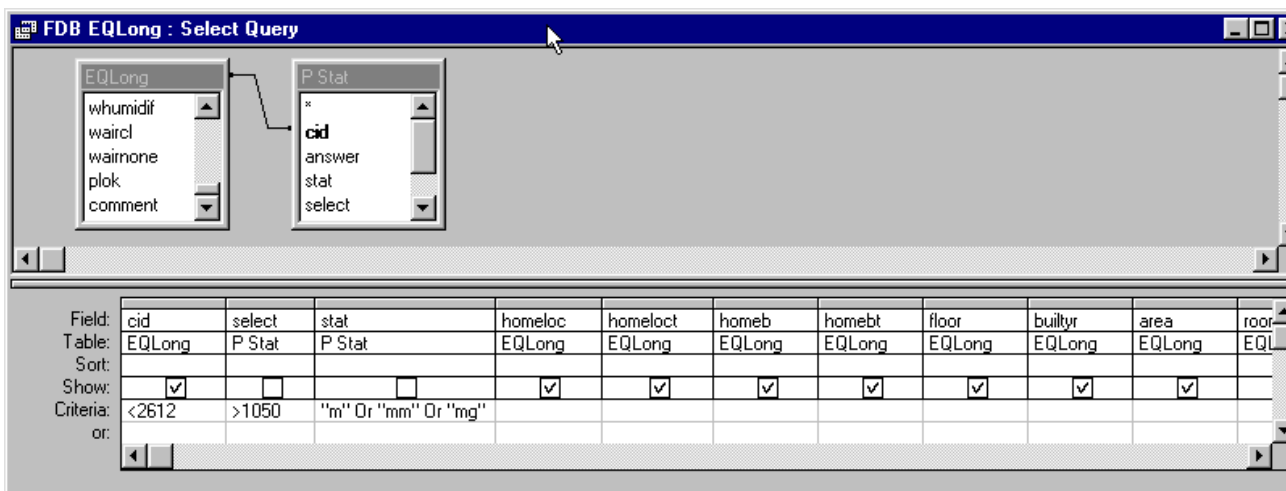

2.6 [FDB EQLong To ExpolisDB] in Basel

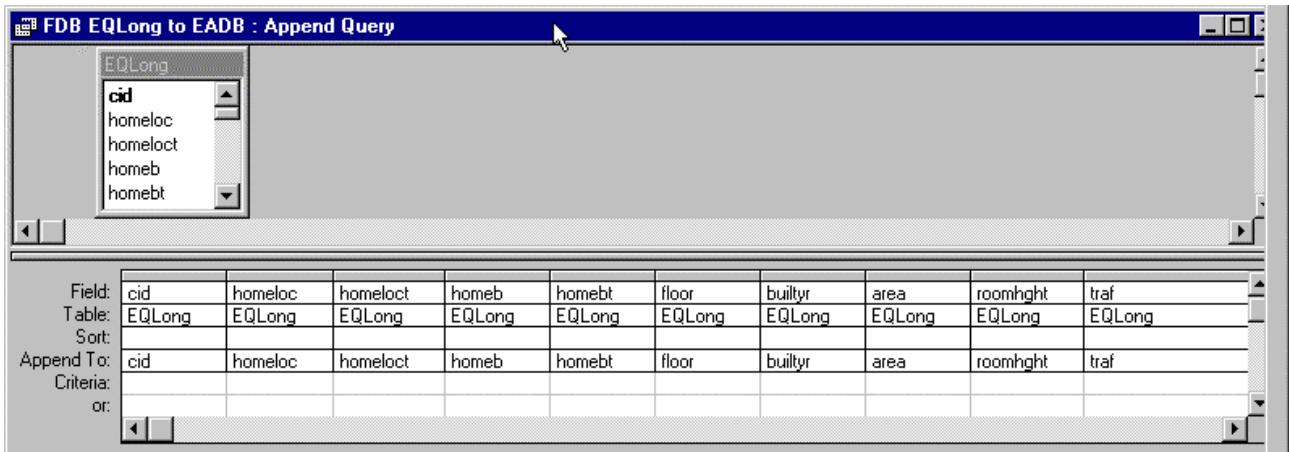

2.7 [FDB ERuns to EADB]

2.7.1 Helsinki

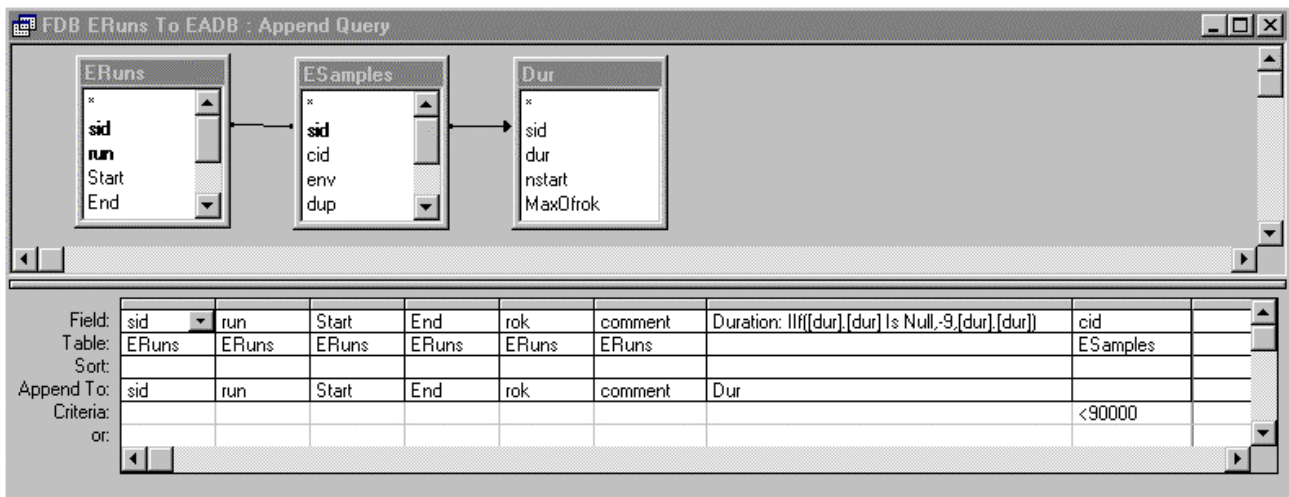

Criteria (cid < 90 000) was used only in Helsinki.

2.7.2 Other centres

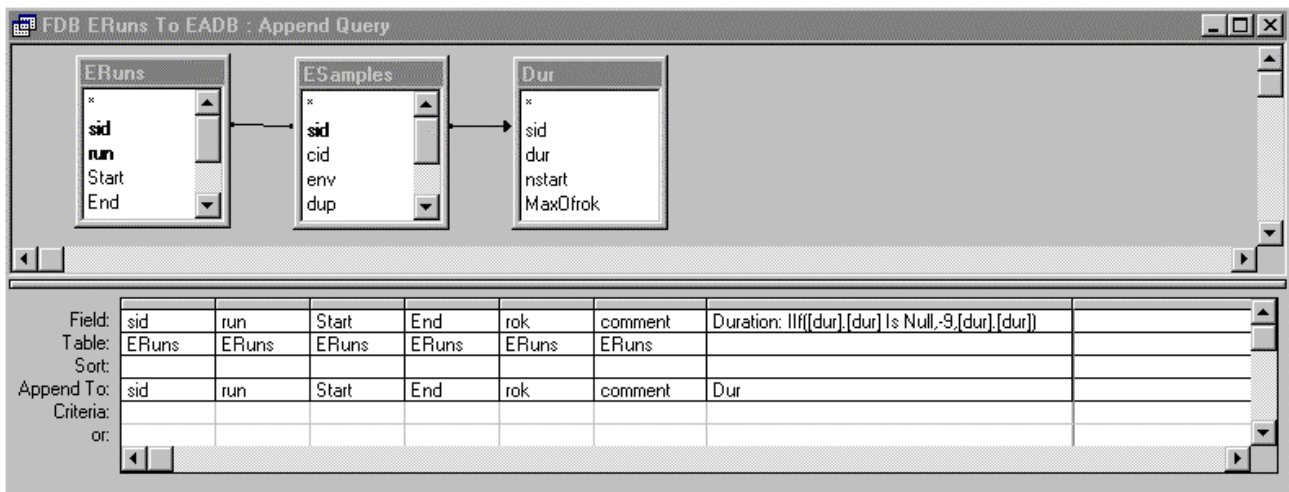

2.8 [FDB ESamples To EADB]

2.8.1 Helsinki

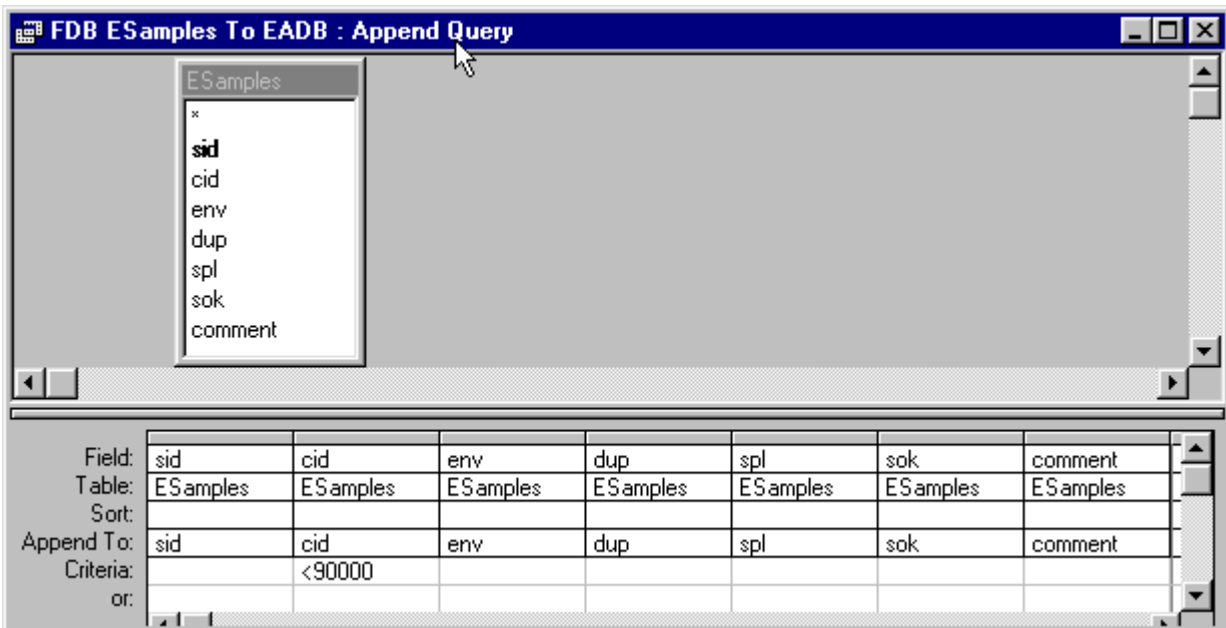

Criteria (cid < 90 000) was used only with Helsinki data.

2.8.2 Other centres

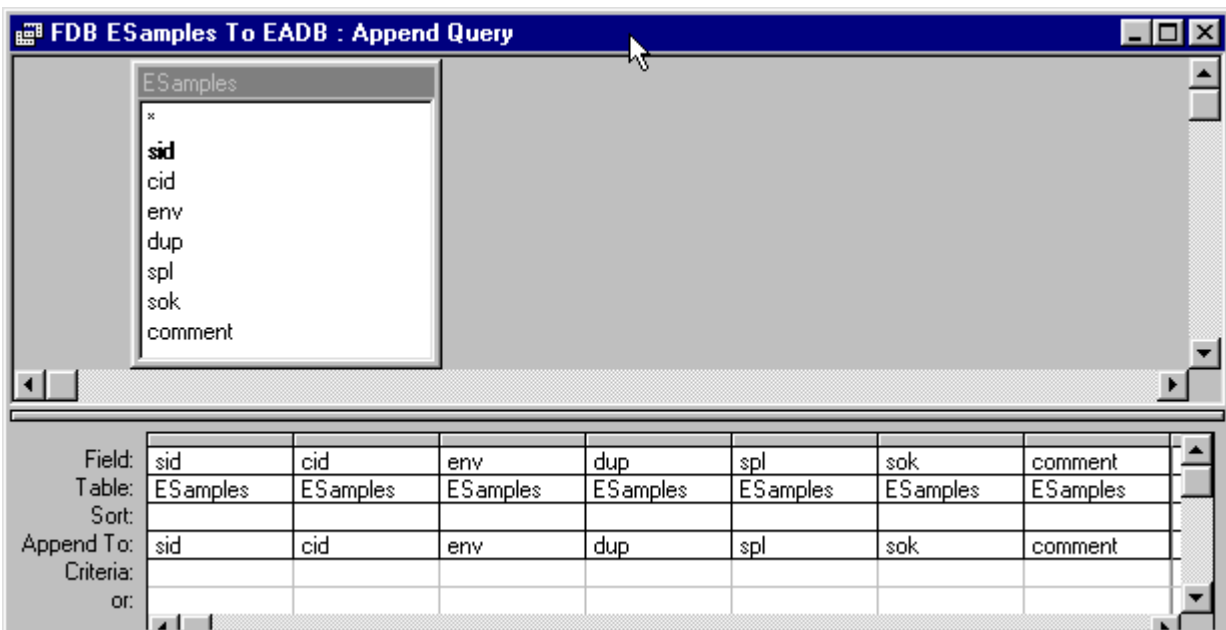

2.9 [FDB NO2 c To EADB]

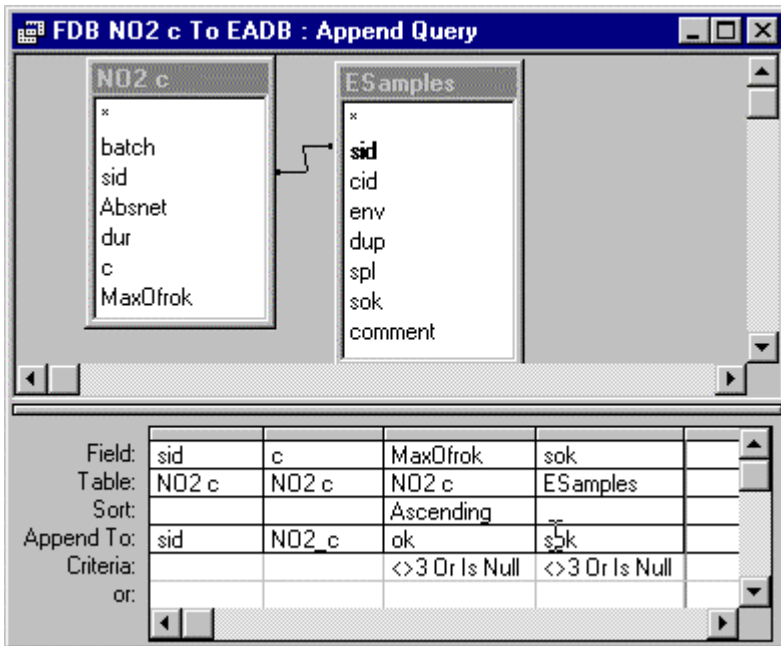

2.10 [FDB NO2 c IOPW To EADB]

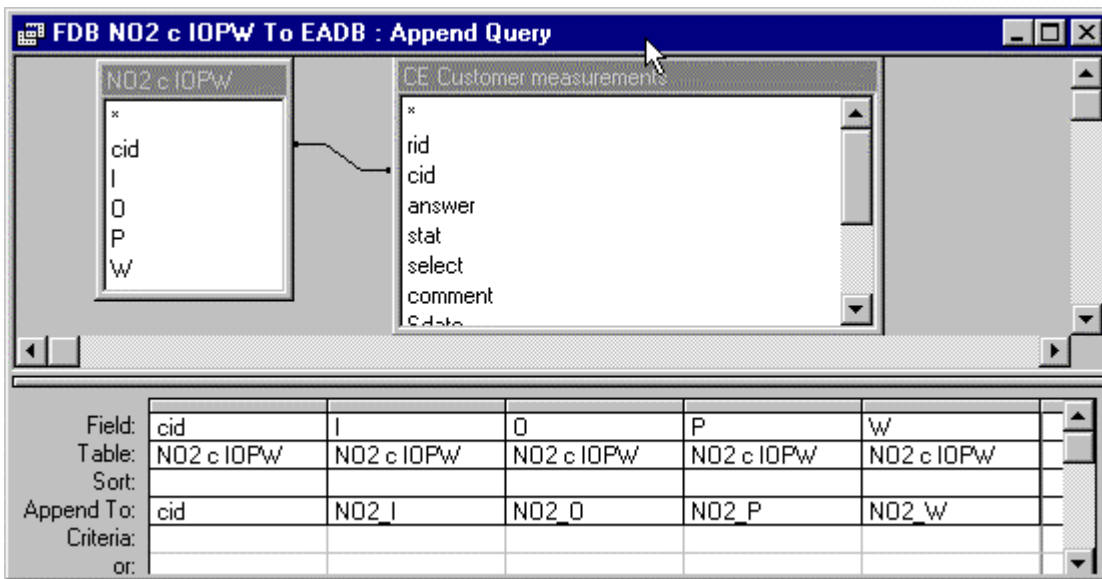

2.11 [FDB P Short Q To ExpolisDB] in Helsinki

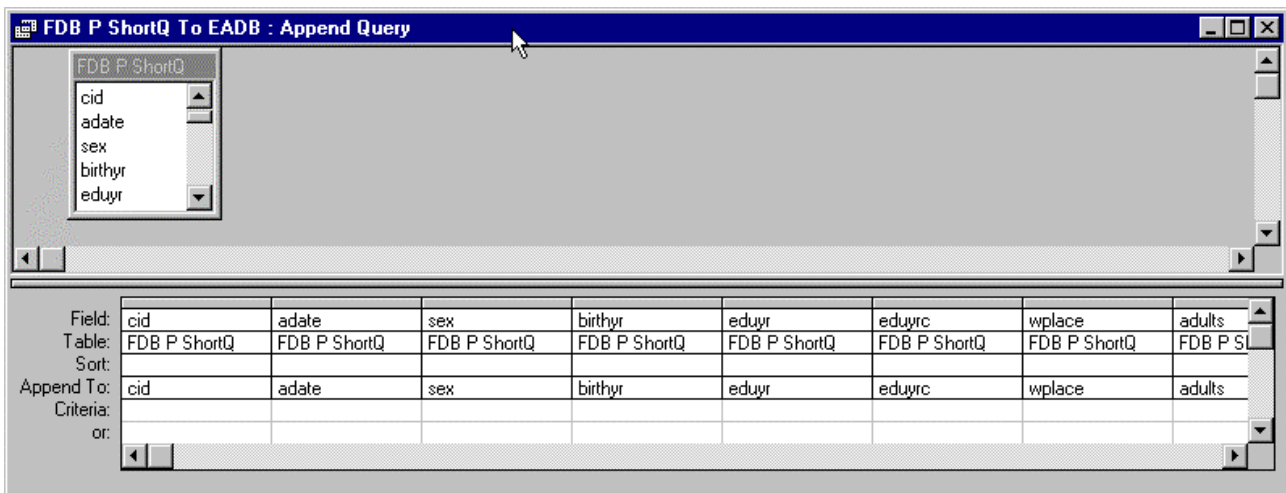

2.11.1 [FDB P Short Q] in Helsinki

FDB P ShortQ : Select Query

Field:	cid	adate	sex	birthyr	eduyr	eduyrc	wplace	adults	children	hrout	hlocB
Table:	P ShortQ	P ShortQ	P ShortQ	P ShortQ	EQ48hr	P ShortQ	P ShortQ	P ShortQ	P ShortQ	P ShortQ	P Shc
Sort:											
Show:	<input checked="" type="checkbox"/>	<input checked="" type="checkbox"/>	<input checked="" type="checkbox"/>	<input checked="" type="checkbox"/>	<input checked="" type="checkbox"/>	<input checked="" type="checkbox"/>	<input checked="" type="checkbox"/>	<input checked="" type="checkbox"/>	<input checked="" type="checkbox"/>	<input checked="" type="checkbox"/>	
Criteria:	<2612										
or:											

2.12 [FDB P Short Q To ExpolisDB] in Basel

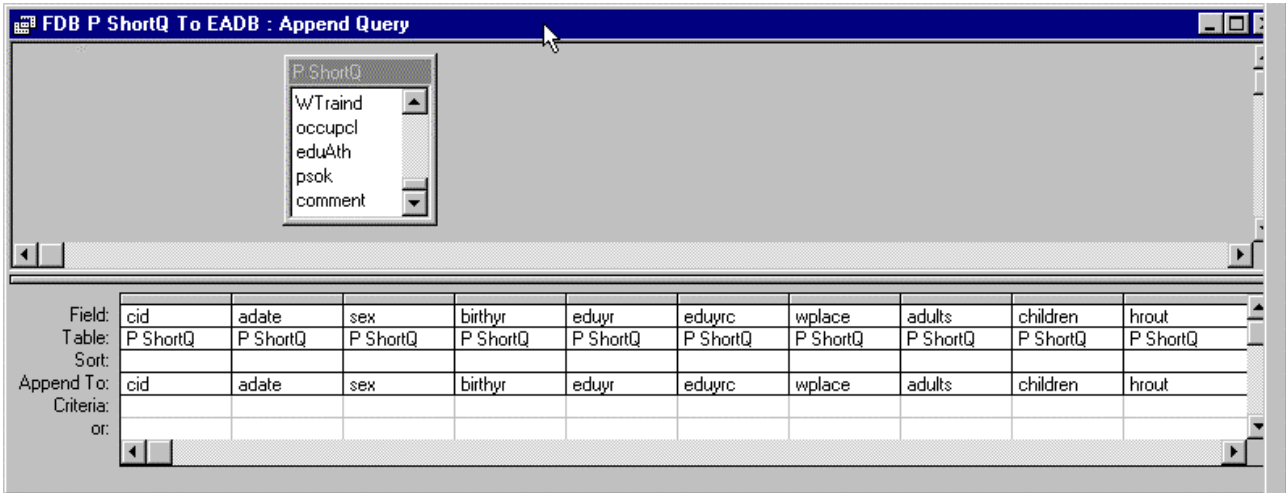

2.13 PM queries and modules

2.13.1 Module [ExpolisPMStd]

This module contains queries needed in PM queries and it was copied to all databases.

2.13.2 [FDB PM c to EADB]

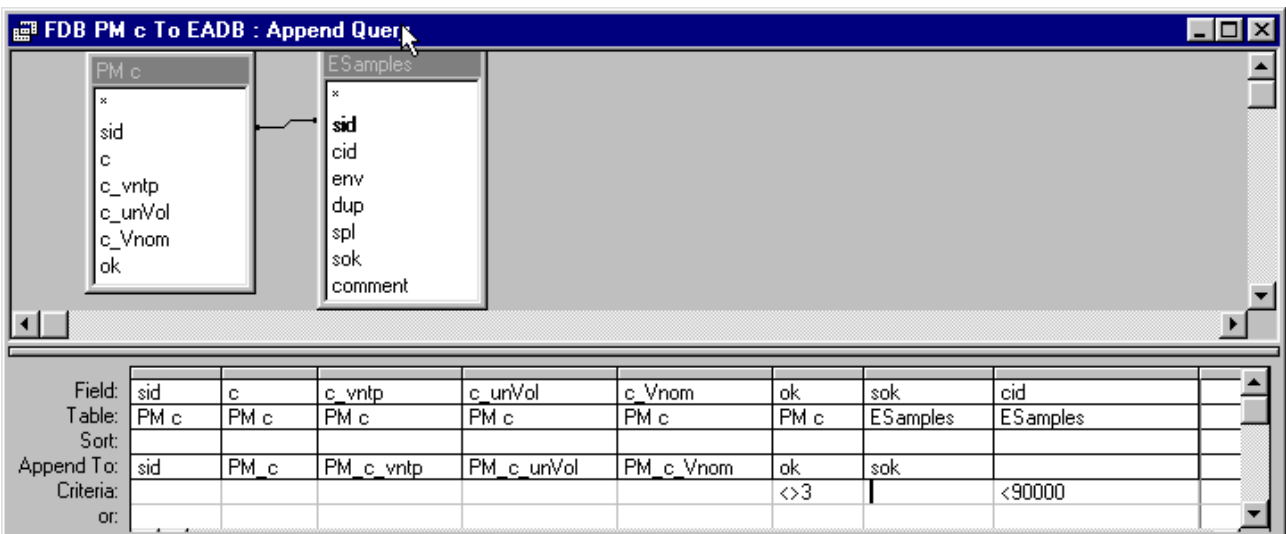

Criteria (cid < 90000) was used only with Helsinki data.

2.13.3 [FDB PM c P1P2P48IOW To ExpolisDB]

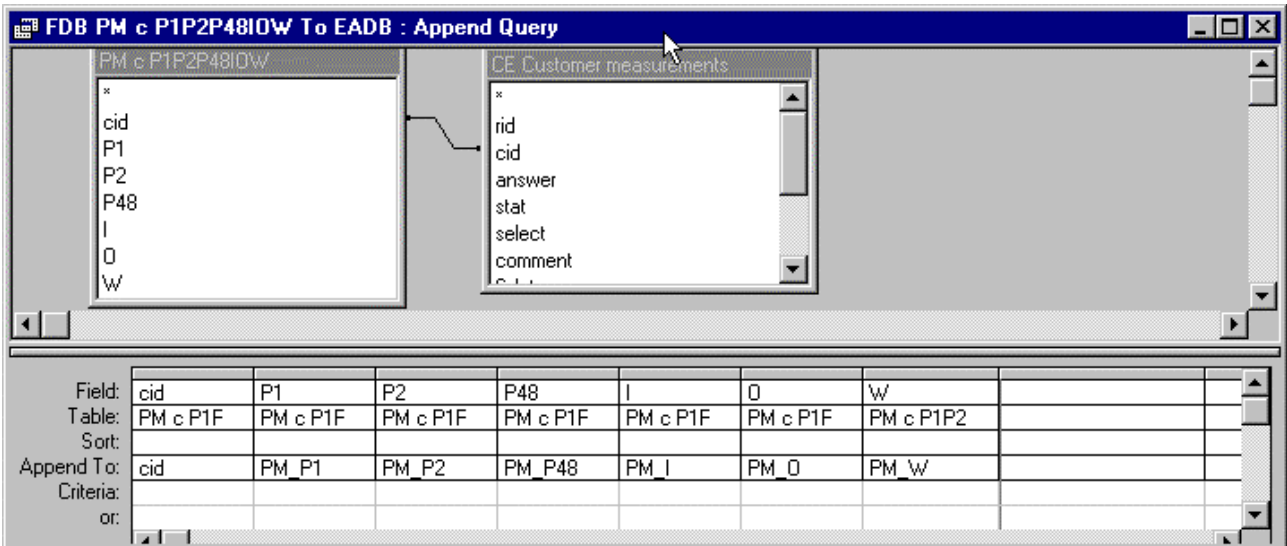

2.14 [FDB VOC lod c To EADB]

2.14.1 Helsinki

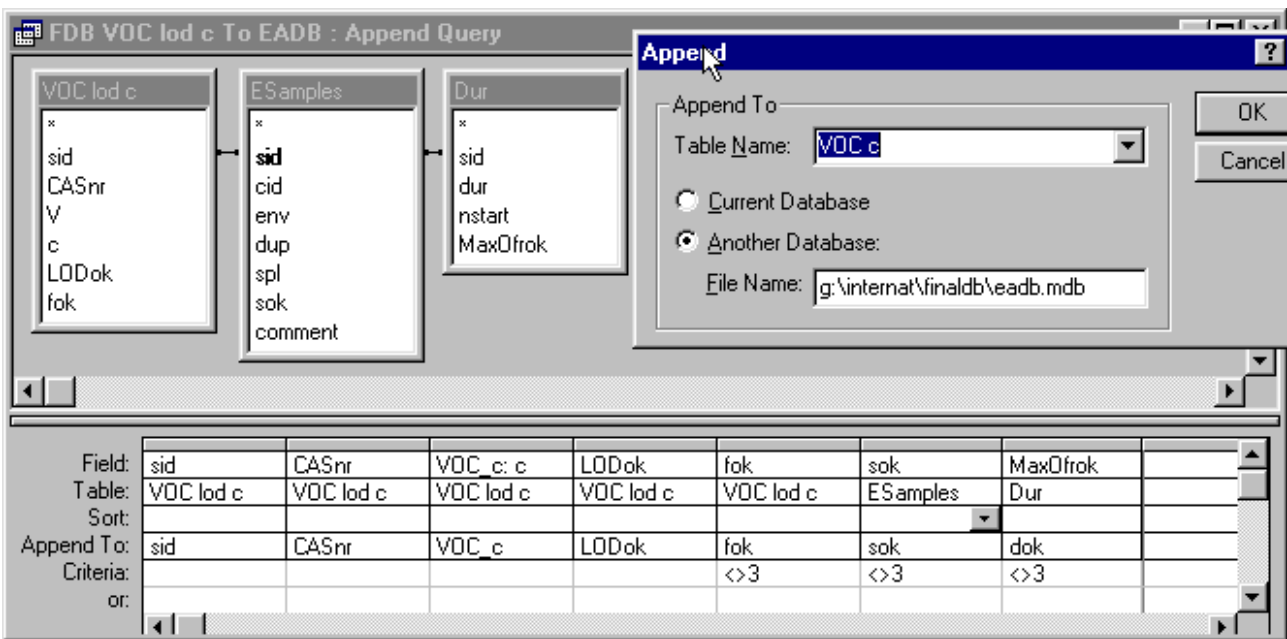

2.14.2 Basel

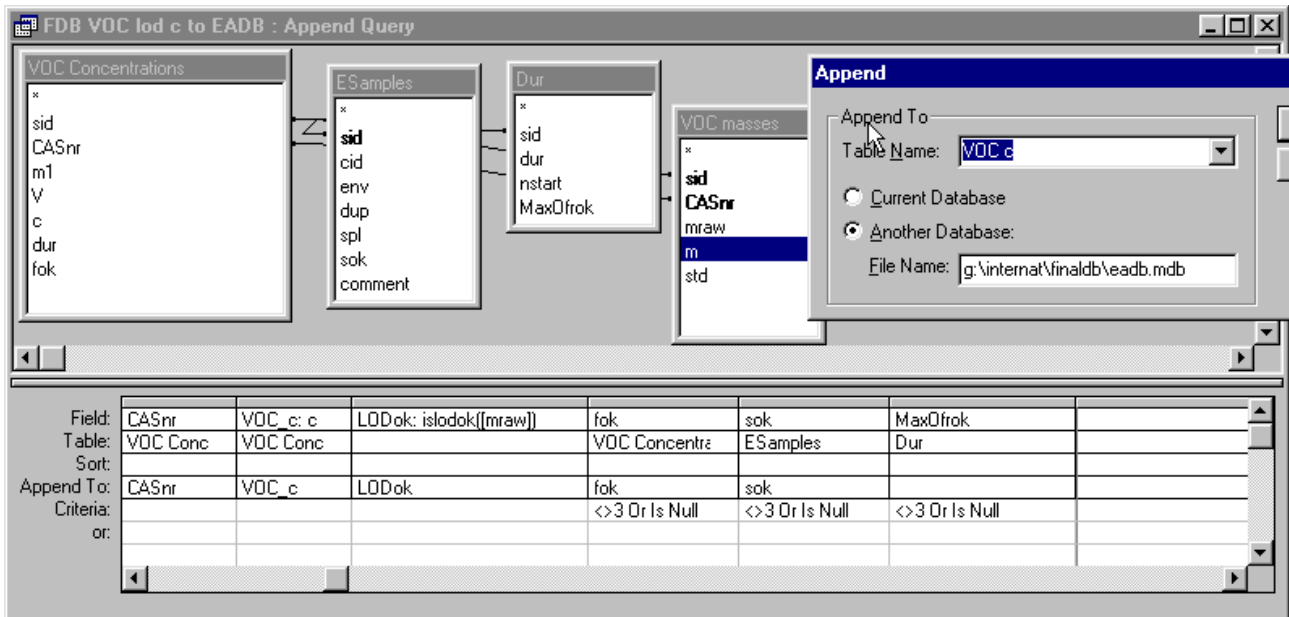

```

Public Function IsLodOK(mraw As Variant)
If (mraw = -20) Then
    IsLodOK = 2
Else
    If mraw <> -20 And mraw <> -8 Then
        IsLodOK = 1
    Else
        If mraw = -8 Then
            IsLodOK = -8
        Else
            IsLodOK = -88
        End If
    End If
End If
End Function
    
```

2.15 [FDB VOC lod c l to EADB]

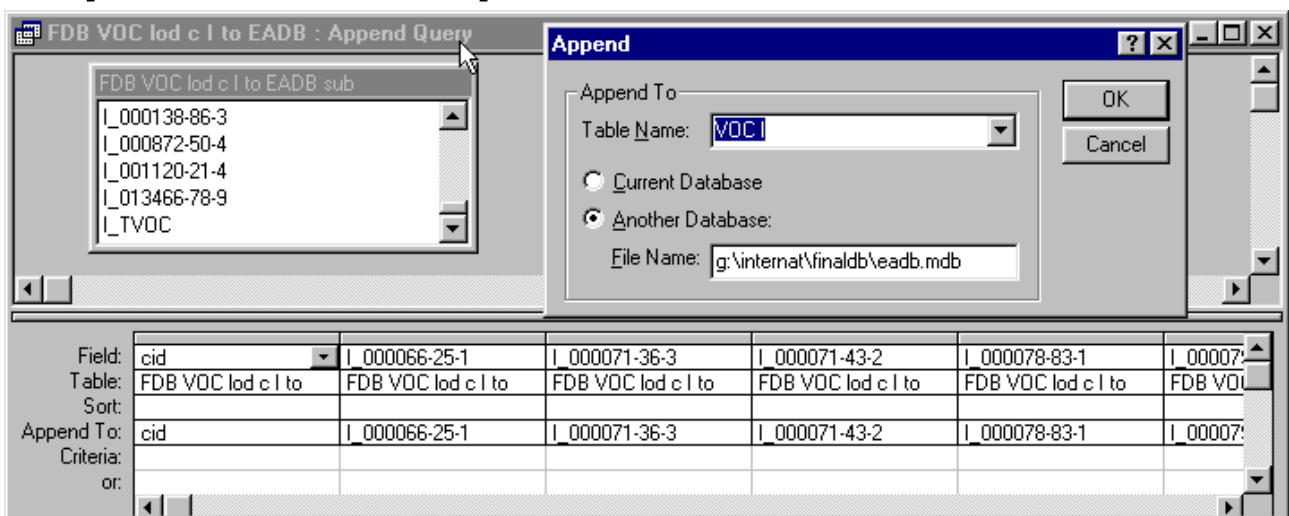

2.15.1 [FDB VOC lod c I To EADB sub]

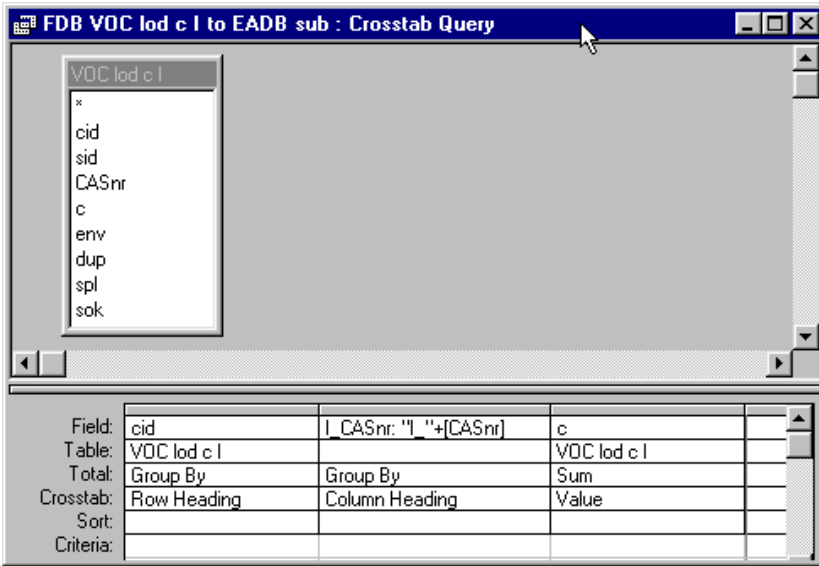

2.16 [FDB VOC lod c O To EADB]

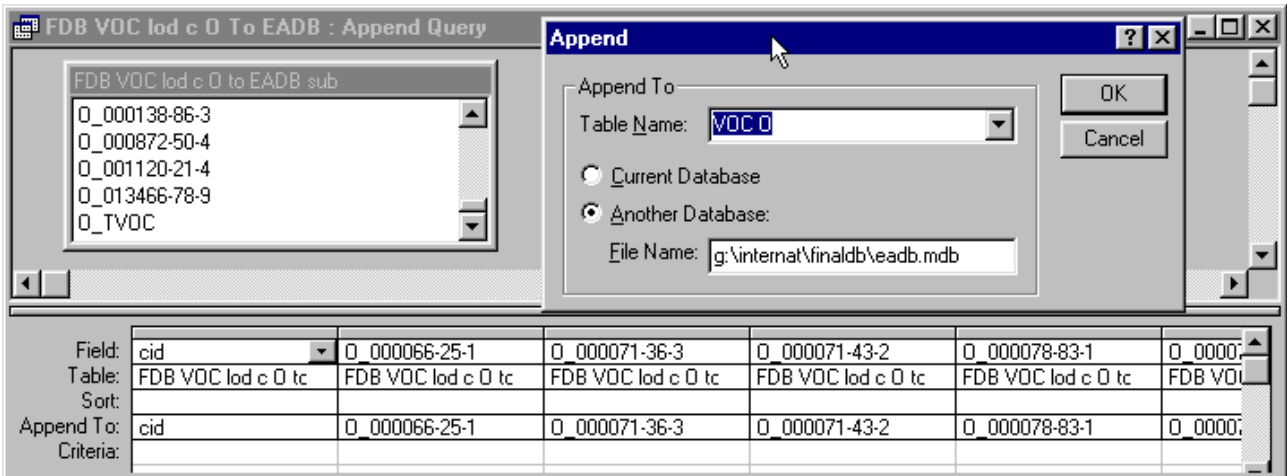

2.16.1 [FDB VOC lod c O To EADB sub]

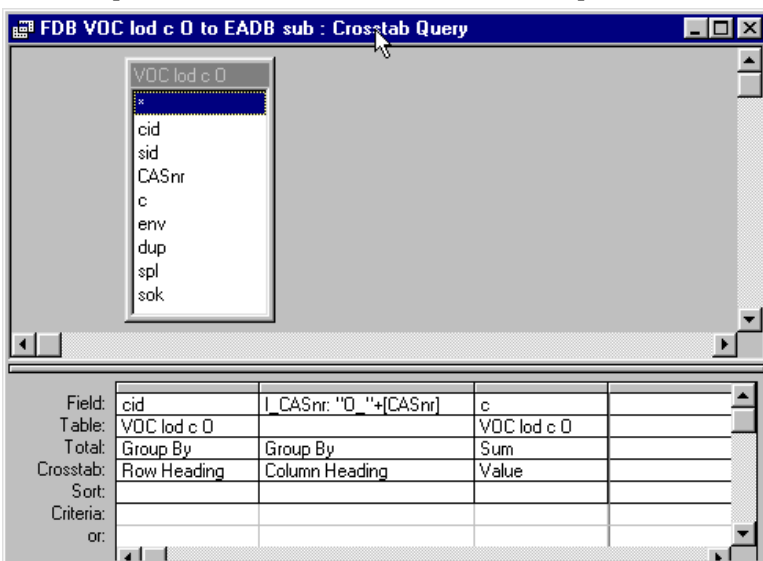

2.17 [FDB VOC lod c P To EADB]

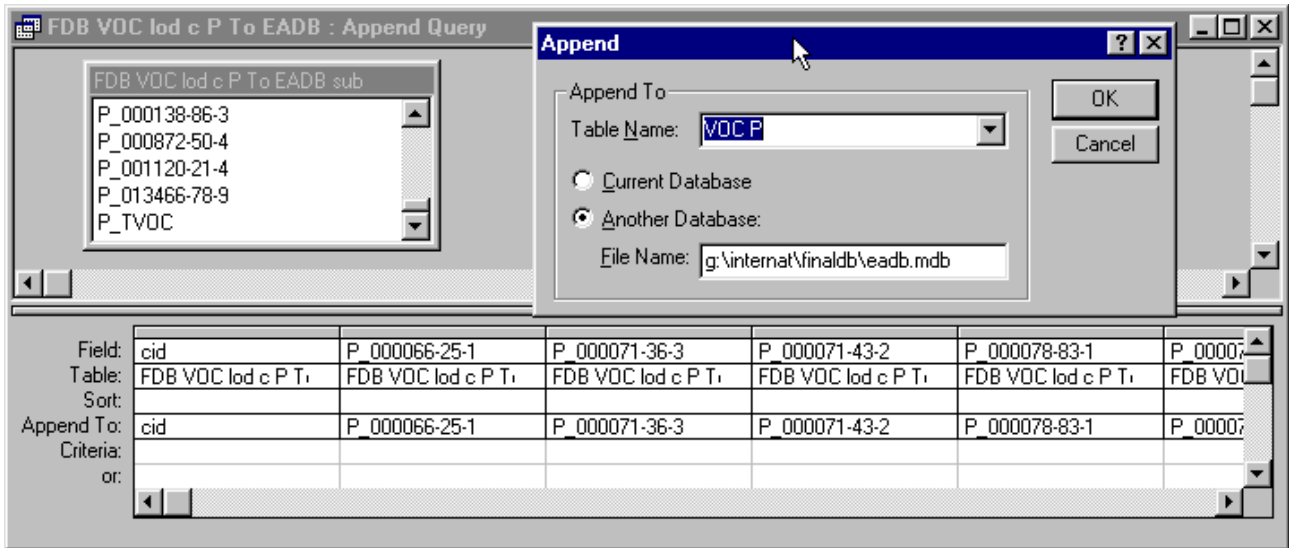

2.17.1 [FDB VOC lod c P To EADB sub]

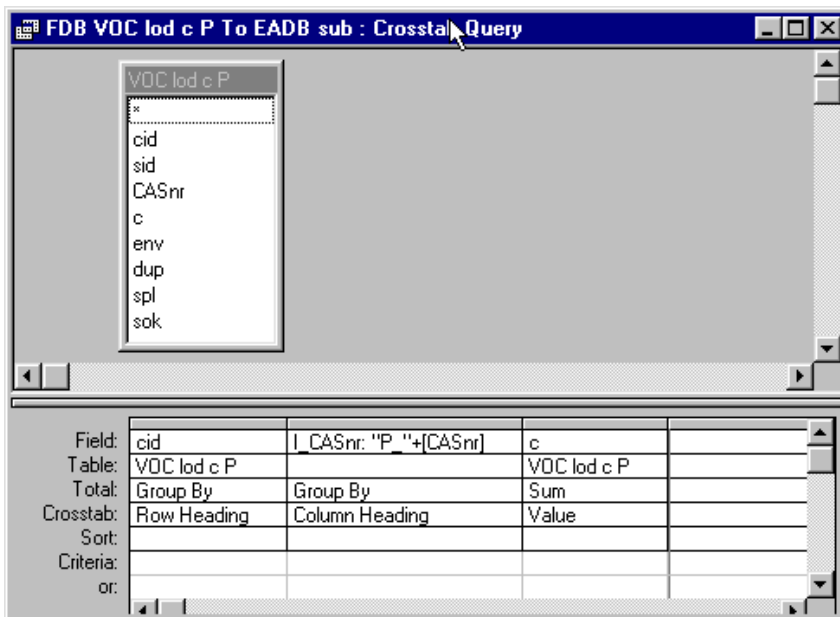

2.18 [FDB VOC lod c W To EADB]

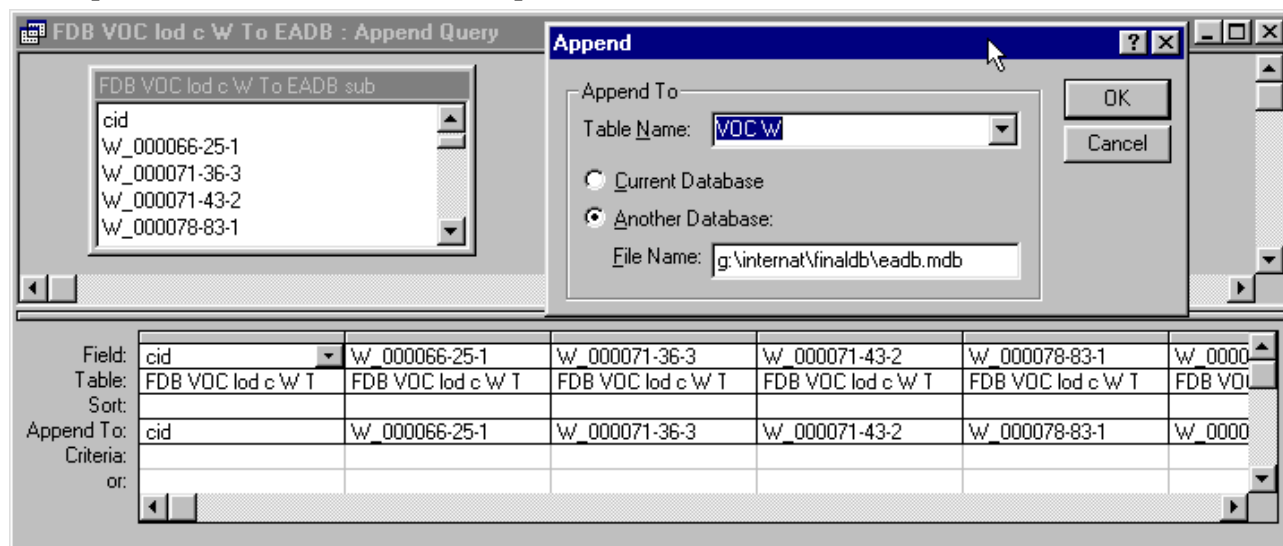

2.18.1 [FDB VOC lod c W To EADB sub]

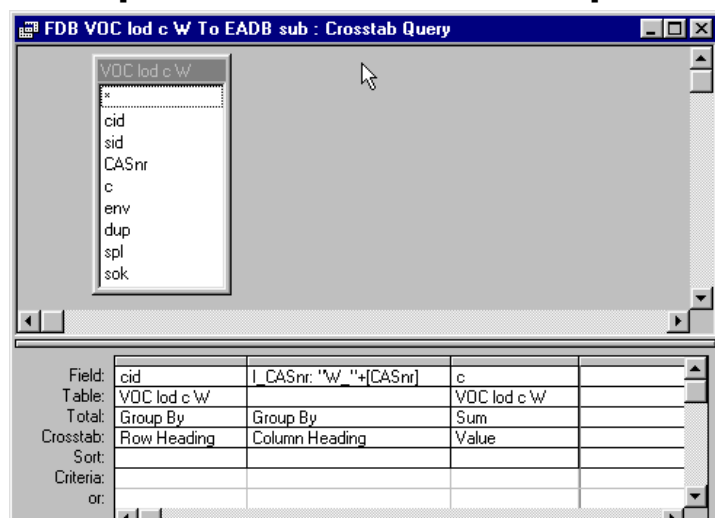

2.19 [FDB VOC Compounds to EADB], only in Helsinki

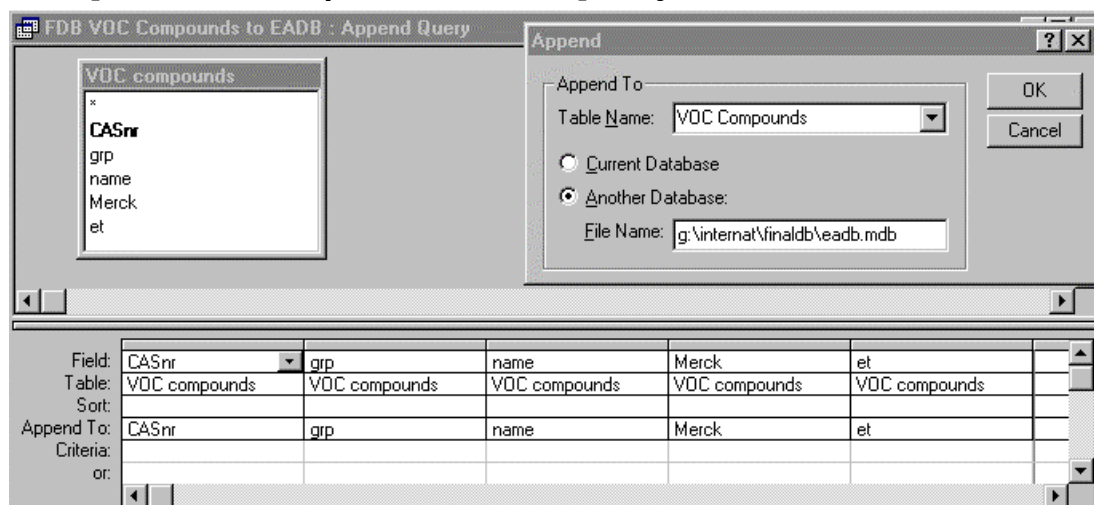

2.20 [FDB Fixedruns to EADB]

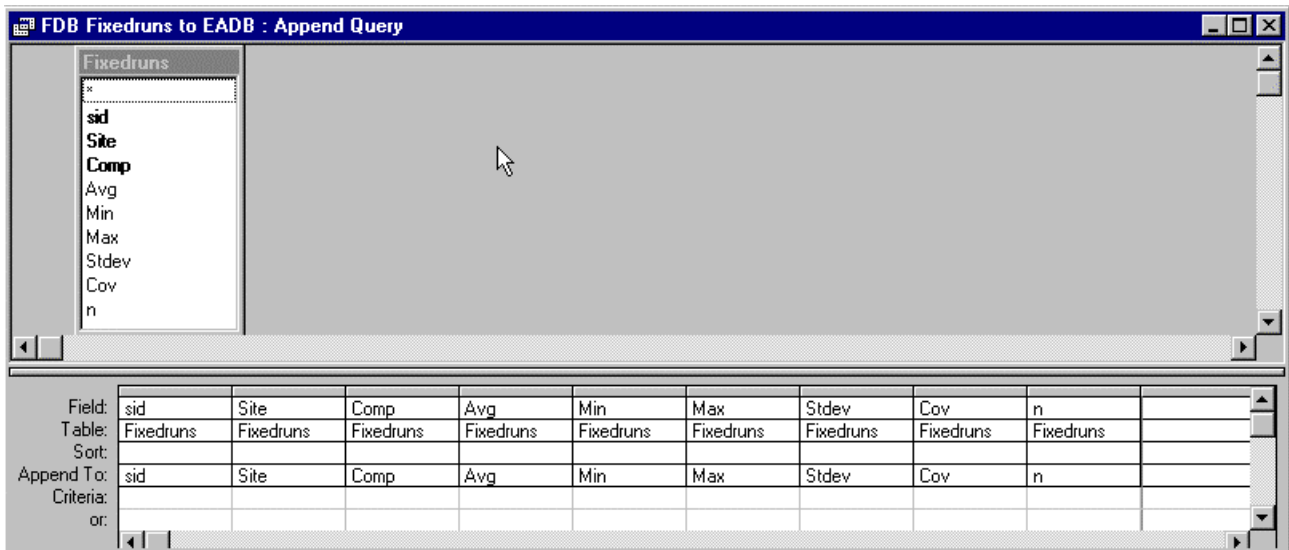

2.21 Appending Black Smoke data

2.21.1 [FDB PM BS to EADB]

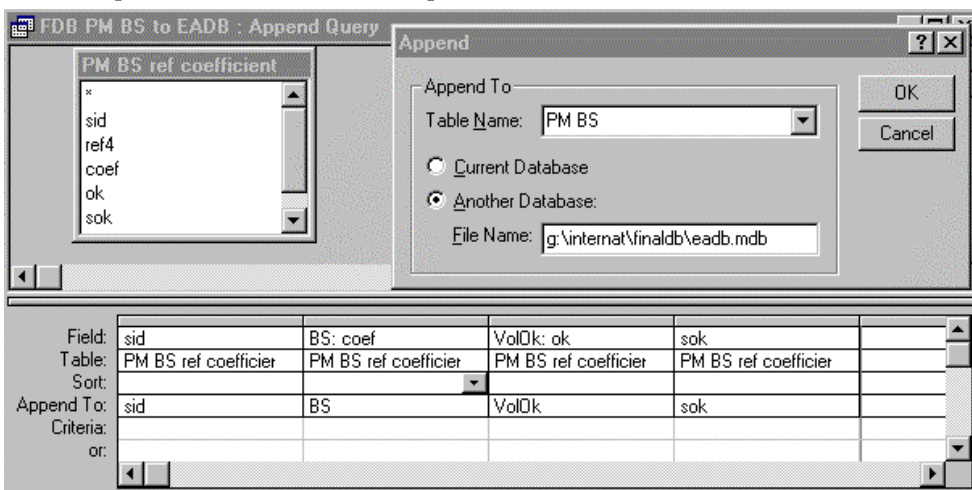

2.21.2 [FDB PM BS IOWP1P2P48]

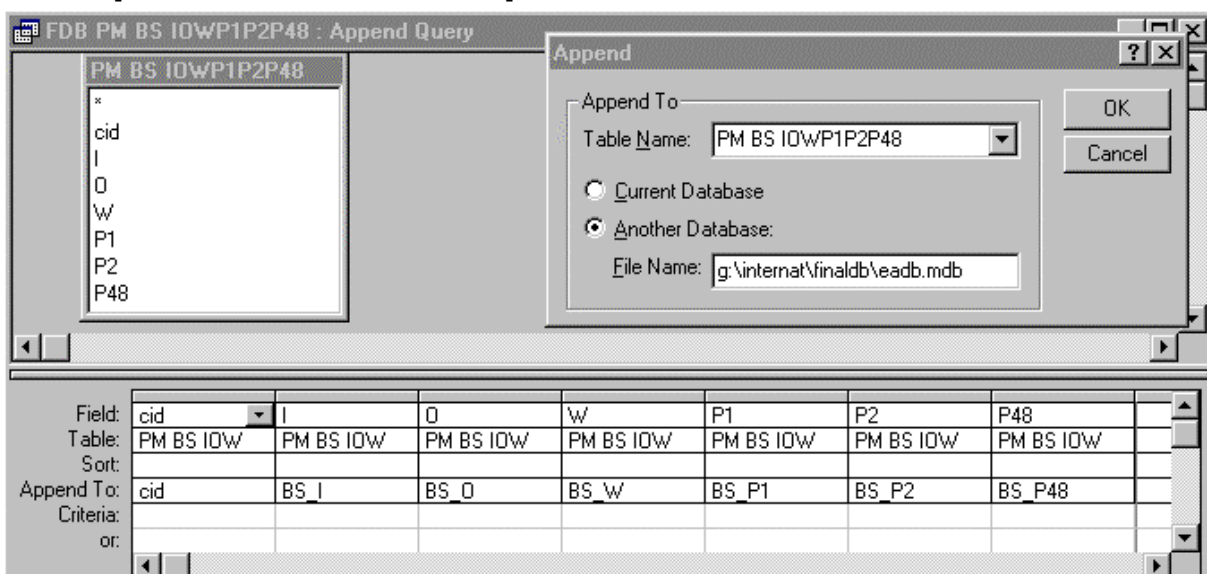

3. Appending EAS data

The way EAS data was appended to Final database is a bit different from other data. Because of the large number of tables (18) and the large number of similar append queries (36) the easiest way to do that was using Visual Basic code. Visual Basic functions create temporary queries that append the data into the Final Database. Temporary queries are based on 6 EAS queries: [EAS c I], [EAS c O], [EAS c W], [EAS c P1], [EAS c P2] and [EAS c P48]. For each EAS queries the code first creates a crosstab query and the results of that query will be appended to the final database using append query similar to other FDB queries.

Following database objects must be copied to each centre's Eadbtool.mdb to append the EAS data to Final Database:

- Module [EAS module]
- Queries [EAS c I], [EAS c O], [EAS c W], [EAS c P1], [EAS c P2] and [EAS c P48]
- Queries [EAS c4 MEM], [EAS ng SumOfMEM], [EAS c], [EAS ngm4] [and EAS bmasses]
- Table [EAS compounds], can be linked to Helsinki.mdb
- Table [EAS masses], imported textfiles from Basel

To append EAS data use debug window (Ctrl+G) and run EAStoCIDB –function. Appendix A shows all functions in [EASModule]. (The code is awful but it works, never heard of _good_ programming ;-)

Only [EAS c] table was created and data imported the same way as other tables in Final database.

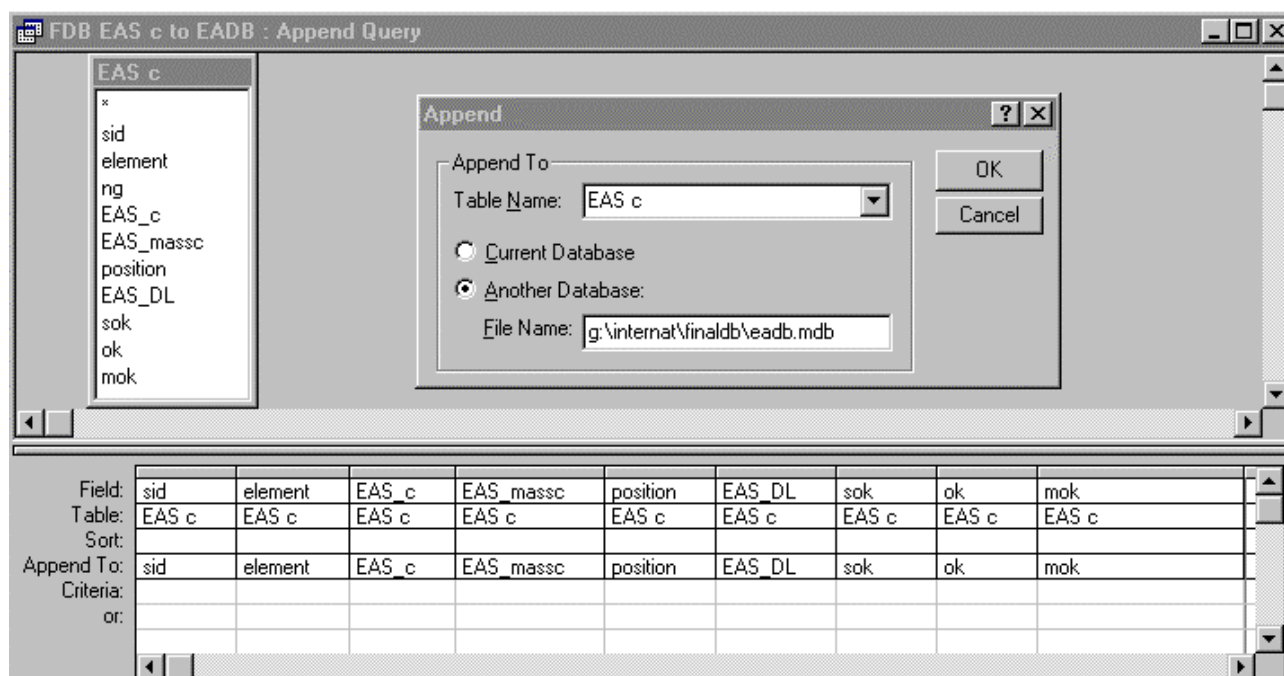

4. Append queries in TMAD15minTOOL

Here are the append queries in TMAD15minTOOL database.

4.1 FDB cid minute totals to EADB

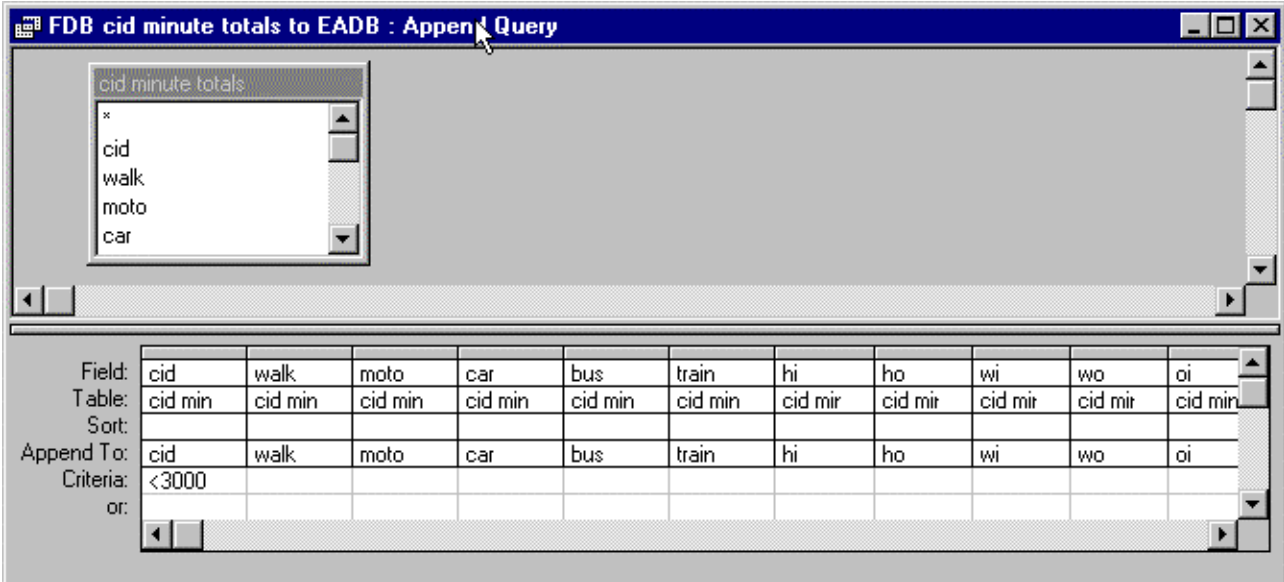

NOTE: (Criteria cid < 3000) was used only with Helsinki data.

4.2 [FDB CO c To EADB]

Might be a rather long lasting query.

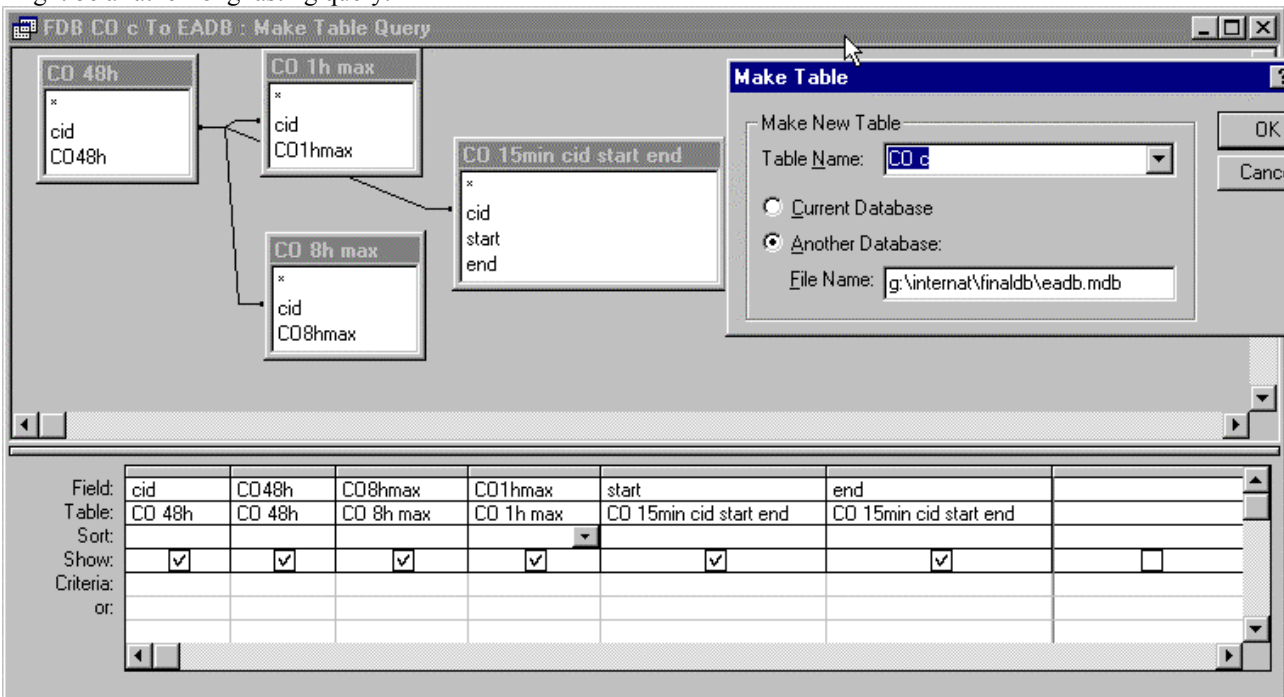

APPENDIX A: [EASModule]

```

' MODULE: EASModule
' Modified: 26.2.2000 Esa Kaarakainen
Option Compare Database
Option Explicit

Public Function FdbEASSub(cType As String, env As String) As recordset
' Creates a recordset based on EAS c query
' and returns it. Recordset is created with crosstab query
' 27.1.2000 eKa
' 4.2.2000 no longer needed ??????
Dim rst As recordset, db As DATABASE
Dim srcCol As String, srcTbl As String
Dim sqlStr As String, strquote As String
On Error GoTo err_fdbEASSub
    strquote = Chr(34) ' = "
    srcTbl = "[EAS c " & env & "]"
    srcCol = "EAS_" & cType

    sqlStr = "TRANSFORM Sum(" & srcTbl & "." & srcCol & ") AS SumOf" & srcCol & "
" & _
        "SELECT " & srcTbl & ".cid " & _
        "FROM " & srcTbl & " " & _
        "WHERE ((([EAS c I].cid)=1)) " & _
        "GROUP BY " & srcTbl & ".cid " & _
        "PIVOT " & strquote & cType + env & "_" & strquote & "+[element]; "
Debug.Print sqlStr
DoCmd.Hourglass True
Set db = CurrentDb
Set rst = db.OpenRecordset(sqlStr, dbOpenSnapshot)

exit_fdbEASSub:
DoCmd.Hourglass False
Exit Function

err_fdbEASSub:
Dim strError As String
Dim errObj As Error
strError = " "
For Each errObj In DBEngine.Errors
    strError = strError & Format$(errObj.Number)
    strError = strError & " : " & errObj.Description
    strError = strError & " (" & errObj.Source & ") . "
    strError = strError & Chr$(13) & Chr$(10)
Next
MsgBox strError
Resume exit_fdbEASSub

End Function

Sub ForceError()
Dim dbsTest As DATABASE
On Error GoTo TestErrorHandler
Set dbsTest = OpenDatabase("DoesNotExist")
Exit Sub

TestErrorHandler:
Dim strError As String
Dim errObj As Error
strError = " "
For Each errObj In DBEngine.Errors
    strError = strError & Format$(errObj.Number)
    strError = strError & " : " & errObj.Description
    strError = strError & " (" & errObj.Source & ") . "
    strError = strError & Chr$(13) & Chr$(10)
Next
MsgBox strError
Resume Next
End Sub
Public Function FdbEAS(cType As String, env As String) As Boolean

```

```

' kauheta koodia, mutta kun ei oikein muuten suostunut onnistumaan
' Inserts results of EAS query to the CIDB
' Params cType and env point which EAS query and which field is inserted,
' e.g. (cType = c) and (env = I): EAS source query and target table = [EAS c I]
,
Dim targetDB As String, targetTbl As String
' Dim srcCol As String, srcTbl As String
Dim iStr1 As String, iStr2 As String, strquote As String
Dim c As String
Dim qdf As QueryDef, db As DATABASE
Dim srcCol As String, srcTbl As String, sqlStr As String
Dim tmpQry As String ' temporary querydef

On Error GoTo err_fdbEAS
targetDB = "g:\internat\finaldb\eadb.mdb"
targetTbl = "[EAS " & cType & " " & env & "]"
c = cType + env + "_"
strquote = Chr(34)
tmpQry = "EAS tmpQry"
Set db = CurrentDb

    srcTbl = "[EAS c " & env & "]"
    srcCol = "EAS_" & cType
    ' tällä stringillä luodaan väliaikainen crosstab query
    sqlStr = "TRANSFORM Sum(" & srcTbl & "." & srcCol & ") AS SumOf" & srcCol & "
" & _
        "SELECT " & srcTbl & ".cid " & _
        "FROM " & srcTbl & " " & _
        "GROUP BY " & srcTbl & ".cid " & _
        "PIVOT " & strquote & cType + env & "_" & strquote & "+[element]; "
    ' "WHERE ((([EAS c I].cid)=1)) " & _ ' just for debuggin, this line must be
between FROM and GROUP BY
' Debug.Print sqlStr
DoCmd.Hourglass True
Set db = CurrentDb ' create temporary query
Set qdf = db.CreateQueryDef(tmpQry, sqlStr)

' Debug.Print qdf.Name

' create insert sql-clause iStr1
iStr1 = "INSERT INTO " & targetTbl & _
        " ( cid, " & getElFlds(cType, env) & ") IN " & targetDB

iStr2 = " SELECT cid, "
iStr2 = iStr2 & c + "Ag, "
iStr2 = iStr2 & c + "Al , "
iStr2 = iStr2 & c + "As , "
iStr2 = iStr2 & c + "Ba , "
iStr2 = iStr2 & c + "Br , "
iStr2 = iStr2 & c + "Ca , "
iStr2 = iStr2 & c + "Cd , "
iStr2 = iStr2 & c + "Cl , "
iStr2 = iStr2 & c + "Co , "
iStr2 = iStr2 & c + "Cr , "
iStr2 = iStr2 & c + "Cu , "
iStr2 = iStr2 & c + "Fe , "
iStr2 = iStr2 & c + "Ga , "
iStr2 = iStr2 & c + "Ge , "
iStr2 = iStr2 & c + "Hg , "
iStr2 = iStr2 & c + "I , "
iStr2 = iStr2 & c + "K , "
iStr2 = iStr2 & c + "Mg , "
iStr2 = iStr2 & c + "Mn , "
iStr2 = iStr2 & c + "Na , "
iStr2 = iStr2 & c + "Ni , "
iStr2 = iStr2 & c + "P , "
iStr2 = iStr2 & c + "Pb , "
iStr2 = iStr2 & c + "Rb , "
iStr2 = iStr2 & c + "S , "
iStr2 = iStr2 & c + "Sb , "
iStr2 = iStr2 & c + "Se , "
iStr2 = iStr2 & c + "Si , "
iStr2 = iStr2 & c + "Sm , "
iStr2 = iStr2 & c + "Sn , "
iStr2 = iStr2 & c + "Sr , "

```

```

iStr2 = iStr2 & c + "Ti , "
iStr2 = iStr2 & c + "Tl , "
iStr2 = iStr2 & c + "Tm , "
iStr2 = iStr2 & c + "V , "
iStr2 = iStr2 & c + "Zn , "
iStr2 = iStr2 & c + "Zr"

iStr2 = iStr2 & " FROM [" & qdf.Name & "];"

iStr1 = iStr1 & iStr2
'Debug.Print iStr1
' Executes insert, case of an error no changes are made
db.Execute iStr1, dbFailOnError
FdbEAS = True

exit_fdbEAS:
' check if tmpQry exists and delete it
If queryExists(tmpQry) = True Then db.QueryDefs.Delete (tmpQry)
DoCmd.Hourglass False
Exit Function

err_fdbEAS:
Dim strError As String
Dim errObj As Error
strError = " "
For Each errObj In DBEngine.Errors
    strError = strError & Format$(errObj.Number)
    strError = strError & " : " & errObj.Description
    strError = strError & " (" & errObj.Source & ") . "
    strError = strError & Chr$(13) & Chr$(10)
Next
MsgBox strError
FdbEAS = False
Resume exit_fdbEAS

Debug.Print "istr1: " & iStr1
Debug.Print "istr2: " & iStr2
Debug.Print "targetDB: " & targetDB
Debug.Print "targetTbl: " & targetTbl
'Debug.Print "srcTbl: " & srcTbl
'Debug.Print "srcCol: " & srcCol
End Function

Public Function getElFlds(cType, env) As String
' Returns all elements from [EAS compounds] in a string
' e.g. cI_Ag, cI_Al, cI_As, cI_Ba...

Dim el As String, astr As String
Dim db As DATABASE, aRst As recordset
Set db = CurrentDb
Set aRst = db.OpenRecordset("select * from [EAS compounds]", dbOpenSnapshot)

astr = ""
aRst.MoveFirst
While Not aRst.EOF
    el = aRst.Fields("element").Value
    astr = astr + cType + env & "_" & el & ", "
    aRst.MoveNext
Wend
getElFlds = Left(astr, (Len(astr) - 2))
'Debug.Print getElFlds

End Function

Public Function EASToCIDB()

Debug.Print "c, I: " & FdbEAS("c", "I")
Debug.Print "massc, I: " & FdbEAS("massc", "I")
Debug.Print "DL, I: " & FdbEAS("DL", "I")

Debug.Print "c, O: " & FdbEAS("c", "O")
Debug.Print "massc, O: " & FdbEAS("massc", "O")
Debug.Print "DL, O: " & FdbEAS("DL", "O")

Debug.Print "c, W: " & FdbEAS("c", "W")
Debug.Print "massc, W: " & FdbEAS("massc", "W")

```



```
Debug.Print "DL, W: " & FdbEAS("DL", "W")

Debug.Print "c, P1: " & FdbEAS("c", "P1")
Debug.Print "massc, P1: " & FdbEAS("massc", "P1")
Debug.Print "DL, P1: " & FdbEAS("DL", "P1")

Debug.Print "c, P2: " & FdbEAS("c", "P2")
Debug.Print "massc, P2: " & FdbEAS("massc", "P2")
Debug.Print "DL, P2: " & FdbEAS("DL", "P2")

' P48 ei toimi vielä
'Debug.Print "c, P48: " & FdbEAS("c", "P48")
'Debug.Print "massc, P48: " & FdbEAS("massc", "P48")
'Debug.Print "DL, P48: " & FdbEAS("DL", "P48")

End Function

Public Function queryExists(qryName As String) As Boolean
' Returns True if current database contains query qryName
Dim IsQuery As Boolean, i As Integer
Dim db As DATABASE
Set db = CurrentDb
IsQuery = False
For i = 0 To db.QueryDefs.Count - 1
    If (db.QueryDefs(i).Name = qryName) Then
        IsQuery = True
    End If
Next i
queryExists = IsQuery
End Function
```

Appendix B: module [EADBCopy]

Originally this function was used for creating a new EADBTOOL.mdb to Helsinki. Functions and subs in this module was used for copying queries to other centre's databases from Helsinki EADBTOOL.

```

Option Compare Database
Option Explicit
' modified 4.4.2000 eKa

Public Function CpQryDefs(trgt As String)
' Copies all queries from current database to
' the database specified in parameter trgt.
' Parameter trgt must be a string pointing to the
' database eg. c:\esa\eadbtool2.mdb
' Names of the queries that cannot be copied is
' printed into the debug-window
'
' eKa 5.3.2000

Dim srcDB As DATABASE, trgtDb As DATABASE
Dim qdef As QueryDef, newQdef As QueryDef
Dim i As Integer
Set srcDB = CurrentDb
Set trgtDb = DBEngine.Workspaces(0).OpenDatabase(trgt)
i = 0

On Error GoTo Err_CpQryDefs

srcDB.QueryDefs.Refresh
trgtDb.QueryDefs.Refresh

For Each qdef In srcDB.QueryDefs

        Set newQdef = trgtDb.CreateQueryDef(qdef.Name, qdef.SQL)
        i = i + 1
Next qdef

Debug.Print "Number of queries added: " & i
Exit Function

Err_CpQryDefs:
    Debug.Print qdef.Name
    Resume Next

End Function

Public Function CpTableDefs(trgt As String)
' EI TOIMI, JOTAKIN HÄIKKKÖÄÄÄÄÄ
Dim srcDB As DATABASE, trgtDb As DATABASE
Dim tdef As TableDef, newTdef As TableDef
Dim i As Integer
' Set srcDB = CurrentDb
' Set trgtDb = DBEngine.Workspaces(0).OpenDatabase(trgt)
' i = 0
' ÄÄÄÄÄÄ , JOTTEI KUKAAN AJA TÄTÄ
' srcDB.TableDefs.Refresh
' trgtDb.TableDefs.Refresh

' On Error GoTo Err_CpTableDefs

' For Each tdef In srcDB.TableDefs
        Debug.Print tdef.Name
        trgtDb.TableDefs.Append tdef
        ' Set newTdef = trgtDB.CreateTableDef(qdef.Name, qdef.SQL)
        i = i + 1
' Next tdef

' Debug.Print "Number of tables added: " & i
' Exit Function

'Err_CpTableDefs:
'    Debug.Print "Error: " & tdef.Name
'    Resume Next

```

End Function

```
Public Function CpQry(qryName As String, trgt As String) As Boolean
' Copies a query from current database to
' the database specified in parameter trgt.
' Parameter trgt must be a string pointing to the
' database eg. c:\esa\eadbtool2.mdb, parameter qryName specifies
' the query to be copied
' Names of the queries that cannot be copied is
' printed into the debug-window
' NOTE! Existing query with same name as qryName will be overwritten!
' Returns True if success, ovr indicates if the old query was overwritten.
' see status from the Debug Window (ctrl+g)
' eKa 3.4.2000
```

```
Dim srcDB As DATABASE, trgtDb As DATABASE
Dim qdef As QueryDef, newQdef As QueryDef
Dim suc As Boolean, ovr As String
```

```
On Error GoTo Err_CpQry
    ovr = ""
    Set srcDB = CurrentDb
    Set trgtDb = DBEngine.Workspaces(0).OpenDatabase(trgt)

    srcDB.QueryDefs.Refresh
    trgtDb.QueryDefs.Refresh

    Set qdef = srcDB.QueryDefs(qryName)
    Set newQdef = trgtDb.CreateQueryDef(qdef.Name, qdef.SQL)
    suc = True
```

```
exit_cpQry:
    Debug.Print trgt & ", " & qryName & ": " & suc & ovr
    CpQry = suc
    Exit Function
```

```
Err_CpQry:
    If Err.Number = 3012 Then
        trgtDb.QueryDefs.Delete(qdef.Name)
        Set newQdef = trgtDb.CreateQueryDef(qdef.Name, qdef.SQL)
        ovr = ", OVR"
        Resume Next
    End If
    MsgBox "Error copying query: " & qryName & ":@" & Err.Number & ": " &
Err.Description & "@" & "Kääk!", vbOKOnly + vbExclamation, "Error"
    suc = False
    Resume exit_cpQry
```

End Function

```
Public Sub cpPMqryt1()
    Call cpPMqryt2("g:\internat\athens\db\eadbtool.mdb")
    Call cpPMqryt2("g:\internat\basel\db\eadbtool.mdb")
    Call cpPMqryt2("g:\internat\grenoble\db\COPY of Basel-Eadbtool.mdb")
    Call cpPMqryt2("g:\internat\milan\db\eadbtool.mdb")
    Call cpPMqryt2("g:\internat\prague\db\eadbtool.mdb")
End Sub
```

```
Public Function cpPMqryt2(targetDb As String)
' Lisää tähän kaikki queryt jotka liittyvät PM-käsittelyyn,
' siis kaikki muuttuneet laskentaqueryt ja FDB -queryt.
' ja sitten kun ajaa cpPMqryt1 -funktion niin kaikki kopioituu
' muihin kantoihin, toivottavasti.
```

```
    Call CpQry("[FDB PM c P1P2P48IOW To EADB]", targetDb)
    Call CpQry("[FDB PM c to EADB]", targetDb)
' 991230 muutetut PM queryt.doc:in mukaan seuraavat
    Call CpQry("[PM volumes SumOfPEMs]", targetDb)
    Call CpQry("[PM volumes]", targetDb)
    Call CpQry("[PM c2 P48]", targetDb)
    Call CpQry("[PM volumes SumOfMEM]", targetDb)
    Call CpQry("[PM c4 MEM]", targetDb)
```

```
' PM std.doc:in mukaan muutetut queryt
  Call CpQry("[PM Flows std]", targetDb)
  Call CpQry("[ECo t]", targetDb)
  Call CpQry("[PM volumes std sub]", targetDb)
  Call CpQry("[PM volumes std]", targetDb)
  Call CpQry("[PM c std]", targetDb)
  Call CpQry("[PM c]", targetDb)
End Function
```

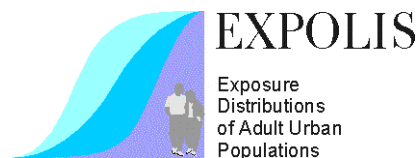

EXPOLIS

CIDB

COMBINED INTERNATIONAL DATABASE

VERSION 3

SEPTEMBER 2002

Sari Alm, Esa Kaarakainen, Otto Hänninen

KTL Environmental Health
P.O.Box 95
FI-70701 KUOPIO
FINLAND



SUMMARY

This document describes the structure and contents of tables in CIDB September 2002, the third version of final Expolis database.

The data is stored on a Microsoft Access version 7 (Access95) database. Also Access97 version of CIDB is available. These databases are not secured. All data in the CIDB is stored in tables. The data in the tables can be viewed and edited using queries.

This database should not be shared or distributed with anyone outside EXPOLIS.

The centers are responsible of the data delivered. If you notice any abnormalities and mistakes in the database, please contact to the responsible center and send also email to Sari.Alm@ktl.fi. You can also visit in the folder (Local databases) of the CD containing "original" data of each center. The local databases are secured and only as Access 95 format. Every center should at least check they own data to be sure that there is no unnecessary missing information or mistakes. All suggestions about corrective actions are the most welcome and will be taken into account in the next version.

Changes in CIDB ver3 (September 2002) compared to CIDB version2 (December 2000)

- Milan fixed and CO data included

- elemental data changed (EAS c...EAS masse P48)

 - Notice:** sulphur data under construction because of problems in quality control

- Oxford data added (no BS data). In the Oxford local database there is also some data of repeated and children's measurements. This data was not included in the CIDB tables.

- small changes in following tables because of data cleaning

 - Fixedruns, ERuns, Dur, PM c, PM c P1P2P48IOW (Helsinki)

 - EQLong (Basel, Prague)

Do not use earlier versions of CIDB! The most updated data is in this version of EXPOLIS CIDB.

0. Conventions

TABLES

1.	CUSTOMERS	5
2.	ESAMPLES	6
3.	ERUNS	7
4.	DUR.....	8
5.	P SHORTQ	9
6.	EQLONG	13
7.	EQ48HR.....	23
8.	PM C	25
9.	PM C P1P2P48IOW	26
10.	NO ₂ C	27
11.	NO ₂ C IOPW	28
12.	TMAD TOTAL MINUTES	29
13.	VOC COMPOUNDS.....	30
14.	VOC C.....	31
15.	VOC I.....	32
16.	VOC O.....	33
17.	VOC P	34
18.	VOC W.....	35
19.	CO C.....	36
20.	EAS C.....	37
21.	EAS C I	38
22.	EAS C O	39
23.	EAS C W.....	40
24.	EAS C P1.....	41
25.	EAS C P2.....	42
26.	EAS C P48.....	43
27.	EAS MASSC I	44
28.	EAS MASSC O.....	45
29.	EAS MASSC W	46
30.	EAS MASSC P1	47
31.	EAS MASSC P2	48
32.	EAS MASSC P48	49
33.	FIXEDRUNS	50
34.	PM BS	51
35.	PM BS IOWP1P2P48.....	52

0. Conventions

Null value No value has been entered; variable is empty.

-9 Missing value for all fields in EADB is -9

Different causes of missing data are not distinguished (eg. data not measured/asked, value lost/missing, parameter not applicable etc)

Null value marks data not entered. All entered but missing data is coded as -9.

-8 Value not applicable (N/A). The answer has no meaning for this record.

Note: In the same field (like field PM_P1 in table P1P2P48IOW) there might be both null and -9 values.

1. Customers

This table lists only the customers. If you need information of microenvironmental or other additional measurements please use ESamples table.

FIELD	Explanation	Coding
Country	Country of the customer	A Athens B Basel G Grenoble H Helsinki M Milan P Prague
Cid	Customer ID	00001...19999 Helsinki. 20000...29999 Athens 30000...39999 Basel 40000...49999 Grenoble 50000...59999 Milan 60000...69999 Prague 70000...79999 Oxford
Sample	What is the main participating status of person	Base population sample Diary person is part of diary subsample Exposure person is part of exposure subsample Note. Dairy and Exposure samples are also part of Base sample
Random	Participant selection	1 randomly selected 2 not randomly selected

Base sample response rates in different Expolis centres

Helsinki	74.6 %
Athens	28.7 %
Basel	48.6 %
Milan	25.4 %
Prague	5 %
Grenoble	100 %
Oxford	about 20 %

2. ESamples

FIELD	Explanation	Coding
cid	Customer ID	00001...19999 Helsinki. 20000...29999 Athens 30000...39999 Basel 40000...49999 Grenoble 50000...59999 Milan 60000...69999 Prague 70000000..70999999 Oxford
sid	sample identification code	100000-999999
env	Microenvironment	I home in O home out W work P personal
dup	Duplicate/blank	1 main sample 2 duplicate 10, 20 blanks
spl	Type of sample	1,2 filters 6,7 Grenoble PEM filters (total, indoor) 8,9 parallel MEM filters, Y-joint V VOC N NO ₂
sok	Is this record ok? Marked in the data cleaning	Null or 1 = data is ok 2 = some problem, usable with care (see comment) 3 = error, data not usable
comment	Comments regarding the data	text

3. ERuns

FIELD	Explanation	Coding
Sid	sample identification code	100000-999999
Run	Number of run	1 first run 2 second run 3 third run 4 fourth run
Start	Start time of sampling	DD.MM.YY HH:MM
End	End time of sampling	DD.MM.YY HH:MM
Rok	Is this record ok?	1 = data is ok 2 = some problem, usable with care (see comment) 3 = error, data not usable
Comment	Comments regarding the data	Text

Grenoble start and end times of sampling are estimations (from EContact table).

4. Dur

Field	Explanation	Coding
Sid	sample identification code	100000-999999
Dur	duration of the measurement	hours with decimal fractions
nstart	number of runs	number
Max of rok	is this record ok?	1 = data is ok 2 = some problem, usable with care (see comment) 3 = error, data not usable

5. P ShortQ

This table contains parameters obtained from the population sample. This data is available for BASE, DIARY and EXPOSURE samples.

Helsinki: eduyr, wheez, astma and nasal data only for DIARY and EXPOSURE samples asked with EQ48hr questionnaire

Grenoble: 19 subjects have been born before 1939 or after 1971. Eduyr, wheez, astma and nasal data also in table EQ48hr.

FIELD	Explanation	Coding
cid	personal ID, running number	00001...19999 Helsinki. 20000...29999 Athens 30000...39999 Basel 40000...49999 Grenoble 50000...59999 Milan 60000...69999 Prague
Adate	answer date	Date [dd.mm.yy]
Sex	gender of the customer	1=male, 2=female
Birthyr	year of birth	4 digit integer, 1939..1971
Eduyr	years of education	Integer
Eduyrc	still studying fulltime	1=yes, 2=no
Wplace	In what kind of a place does the person work in	1=working home 2=working indoors, in one place 3=working in one building 4=working outdoors in one place 5=working in traffic 6=other (specify) 7=not working 8=many places
Wplacet	Workplace=6, other; specify	Text
Adults	number of adult (>=18) family members	Integer
Children	number of children (<18) family members	Integer
Hrout	hours spent outdoors yesterday	Float (eg. 1.25 = 1h15min)

FIELD	Explanation	Coding
HlocB	home location type	1=center of city/village, high traffic 2=center of city/village, low traffic 3=periphery, close to traffic 4=periphery, low traffic 5=periphery, no traffic This question is used in Basel
Htraffic	amount of heavy traffic close to home	1=all the time 2=often 3=rarely 4=never
Swalkt	Summer walking time [min]	Integer
Wwalkt	Winter walking time [min]	Integer
Smotot	Summer motor bike time [min]	Integer
Wmotot	Winter motor bike time [min]	Integer
Scart	Summer car driving time [min]	Integer
Wcart	Winter car driving time [min]	Integer
Wbust	Winter bus time [min]	Integer
Sbust	Summer bus time [min]	Integer
Straint	Summer train time [min]	Integer
Wtraint	Winter train time [min]	Integer
Wheez	Wheezing or whistling during last 12 months	1=yes, 2=no, 3=don't know
Astma	Astma attack during last 12 months	1=yes, 2=no, 3=don't know
Nasal	Nasal allergies, hay fever	1=yes, 2=no, 3=don't know
Ssmoke	Regular smoking (1 cigarette/day for last year)	1=yes 2=no
Particip	Is the person willing to participate the measurements	1=yes 2=yes, diary study only 3=no, don't want to 4=no, not living/working in the area 5=no, most of the time not in the area
Marital	Marital status given by the person	1=married 2=not married 3=divorced 4=widow
Occup	Occupational status	1= employed 2= self employed (entrepreneur) 3= unemployed 4= housewife 5= student 6= retired 7=other (specify)
Occupst	Occupstat specification	Text
Occupat	Occupational title	Text
Sens	Is the person sensitive to noise or air pollution	1=sensitive to noise 2=sensitive to air pollution 3=not sensitive 4=sensitive to both noise and air pollution

FIELD	Explanation	Coding
nat	Nationality group	Text
Harea	home floor area in [m ²]	Integer
Htype	type of home building	1=separate house 2=attached house 3=high rise
Hsmoke	Someone else smoking at home	1=yes, indoors 2=yes, but only outdoors 3=no one is smoking at home
Stove	Stove used for cooking at home	1=electric 2=gas 3=wood/coal 4=electric and gas 5=electric and wood/coal 6=gas and wood/coal
Wloc	In what kind of surroundings is the workplace located (only in Helsinki)	1=Center of the city 2=Commercial zone 3=Industry area 4=High rise building area 5=Small building area 6=Rural area 7=Traffic dominated area 8=Many places *
Wwalkd	Winter walking distance [km]	integer
Wmotod	Winter motorbike distance [km]	integer
Wcard	Winter car driving distance [km]	integer
Wbusd	Winter bus distance [km]	integer
Wtraind	Winter train distance [km]	integer
Occupcl	Occupational status employed subclassing according to Finnish statistical center	1= farmer 2= entrepreneur 3= white collar 4= blue collar 5= worker 6= student 7= retired 8= other (eg. Housewife, unemployed) Finnish Statistical Center classification

FIELD	Explanation	Coding
EduAth	education class for Athens	1=no education (illiterate) 2= at least few years elementary school 3= at least few years 3-grade high school 4= at least few years 6-grade high school 5= at least few years Lyceum 6= at least few years university or technical school This variable is for Greek education system, used in Athens
Psok	is this record ok?	1=ok 2=some problem (usable with care) 3=error (data not usable)
Comment	any comments regarding the data	text

6. EQLong

This data is available for DIARY and EXPOSURE samples.

FIELD	Explanation and Coding
cid	Personal ID (see table PShortQ for coding)
Homeloc	IQ1 1=down town 2=suburban area w. high rises 3=suburban, small buildings 4=industrial area 5=other
Homeloc1	IQ1 Home location explanation (if 5=other)
Homeb	IQ2 1=single family detached 2=single family, attached 3=office/appartement building 4=industrial building 5=other
Homebt	IQ2 Home building type explanation (if 5=other)
Floor	IQ3 Home floor 0=ground level
Builtyr	IQ4 Home building is built 1=after 1989 2=1980-89 3=1970-79 4=before 1970 5=don't know
area	IQ5 floor area in [m ²], including all rooms
roomhght	IQ6 Room height [m]
traf	IQ7 Traffic volume on the nearby street 1=heavy, continuous, 2=medium, 3=light
htraf	IQ8 Truck/heavy vehicle traffic volume on the nearby street 1=all the time 2=often 3=rarely 4=never

FIELD	Explanation and Coding
garage	IQ9 1;yes; 2;no; 3;don't know
wwcarpt	IQ10 Wall to wall carpet 1;yes; 2;no;- 9;missing
ocarpt	IQ10 Other carpet 1;yes; 2;no; -9;missing
curtain	IQ10 Curtains 1;yes; 2;no; -9;missing
furnish	IQ10 Soft furnishings 1;yes; 2;no; -9;missing
dglaz	IQ10 Double glazing 1;yes; 2;no; -9;missing
linol	IQ10 Linoleum floor 1;yes; 2;no; -9;missing
PVC	IQ10 PVC (plastic) floor 1;yes; 2;no; -9;missing
Woodflo	IQ10 Wooden floor 1;yes; 2;no; -9;missing
Woodpan	IQ10 Wooden panels 1;yes; 2;no; -9;missing
Plaster	IQ10 Plaster board walls/ceilings 1;yes; 2;no; -9;missing
Chipbrd	IQ10 Chipboard walls 1;yes; 2;no; -9;missing
wallpap	IQ10 Wallpaper (any kind) 1;yes; 2;no; -9;missing
none1	IQ10 None above alternatives 1;yes; 2;no; -9;missing

FIELD	Explanation and Coding
renowal	IQ11 Wall painting/paper renovation in last year 1;yes; 2;no; -9;missing
renoflo	IQ11 Floor repair/polish/varnishing in last year 1;yes; 2;no; -9;missing
renowat	IQ11 Water/sewage system renovation in last year 1;yes; 2;no; -9;missing
renowin	IQ11 Window/door renovation in last year 1;yes; 2;no; -9;missing
renoins	IQ11 Insulation renovation in last year 1;yes; 2;no; -9;missing
wallcon	IQ11 Wall construction/removal in last year 1;yes; 2;no; -9;missing
none2	IQ11 None above alternatives 1;yes; 2;no; -9;missing
waterd	IQ12 Damages in previous question caused by water 1;yes; 2;no; -9;missing
waterdn	IQ13 Is there any water damage that has not been fixed 1;yes; 2;no; -9;missing
cats	IQ14 Number of pets in customer's home
dogs	IQ14 Number of pets in customer's home
birds	IQ14 Number of pets in customer's home
other	IQ14 Number of pets in customer's home
othert	IQ14 Other animals explanation
smoking	IQ15 How many persons smoke in the home (including the recipient)
cigaret	IQ16 How many are consumed per day inside the home
cigarlo	IQ16 How many are consumed per day inside the home
cigars	IQ16 How many are consumed per WEEK inside the home
pipeful	IQ16 How many are consumed per WEEK inside the home

FIELD	Explanation and Coding
heatdis	IQ17 Home heating: district heating 1;yes; 2;no; -9;missing
heatcen	IQ17 Home heating: central heating in the building 1;yes; 2;no; -9;missing
heatele	IQ17 Home heating: single stoves/heaters with electricity 1;yes; 2;no; -9;missing
heatgas	IQ17 Home heating: single stoves/heaters with gas 1;yes; 2;no; -9;missing
heatcoa	IQ17 Home heating: single stoves/heaters with coal 1;yes; 2;no; -9;missing
heatwoo	IQ17 Home heating: single stoves/heaters with wood 1;yes; 2;no; -9;missing
heatker	IQ17 Home heating: single stoves/heaters with kerosene/parafine 1;yes; 2;no; -9;missing
heatoil	IQ17 Home heating: single stoves/heaters with fuel/oil 1;yes; 2;no; -9;missing
heatfir	IQ17 Home heating: fire place 1;yes; 2;no; -9;missing
heatnon	IQ17 Home heating: no heating 1;yes; 2;no; -9;missing
heatoth	IQ17 Other heating (specify) 1;yes; 2;no; -9;missing
heatott	IQ17 Home heating, explanation

FIELD	Explanation and Coding
aircond	IQ18 Air conditioning in the home 1;yes; 2;no; -9;missing
humidif	IQ18 Humidifier in the home 1;yes; 2;no; -9;missing
aircl	IQ18 Electric/filter cleaner or ionizer in the home 1;yes; 2;no; -9;missing
airnone	IQ18 None above 1;yes; 2;no; -9;missing
cookel	IQ19 Cooking by electricity 1;yes; 2;no; -9;missing
cookgas	IQ19 Cooking by gas 1;yes; 2;no; -9;missing
cooksol	IQ19 Cooking by solid fuel(s) 1;yes; 2;no; -9;missing
cookoth	IQ19 Cooking by other (specify) 1;yes; 2;no; -9;missing
cooknon	IQ19 No cooking in home 1;yes; 2;no; -9;missing
cookt	IQ19 Cooking by other energy: specify
cookfan	IQ20 Kitchen fan/vent 1;yes, air back to kitchen; 2;yes, extractor with switch; 3;yes, connected to ventillation; 4;no; 5;I don't know
naphtal	IQ21 Do you use anti-moth products 1;yes; 2;no; 3;don't know; -9;missing
freshen	IQ22 Do you use air fresheners 1;yes; 2;no; 3;don't know; -9;missing
freshent	IQ23 Brand names of used air fresheners (if any)

FIELD	Explanation and Coding
WWalkt	IIQ1 One way commuting to work in winter : time spent walking [min]
WMotot	IIQ1 One way commuting to work in winter : time spent on motorcycle [min]
WCart	IIQ1 One way commuting to work in winter : time spent in car/taxi [min]
WBust	IIQ1 One way commuting to work in winter : time spent in bus/tram [min]
WTraint	IIQ1 One way commuting to work in winter : time spent in train/metro [min]
wplace	IIIQ0 1;in, one spot; 2;one building; 3;home; 4;out one spot; 5;traffic; 6;not working; 7;many places; -9;missing
persons	IIIQ1 How many persons normally work in the same room (including yourself)
wsmoke	IIIQ2 How many of the persons smoke in the work room
wcigaret	IIIQ3 How many are consumed per day in the work room
wcigarlo	IIIQ3 How many are consumed per day in the work room
wcigars	IIIQ3 How many are consumed per WEEK in the work room
wpipeful	IIIQ3 How many are consumed per WEEK in the work room
wfloor	IIIQ4 Work room floor 0=ground level
wwwcarpt	IIIQ5 Wall to wall carpet 1;yes; 2;no; -9;missing
wocarpt	IIIQ5 Other carpet 1;yes; 2;no; -9;missing
wcurtain	IIIQ5 Curtains 1;yes; 2;no; -9;missing
wfurnish	IIIQ5 Soft furnishings 1;yes; 2;no; -9;missing
wzglaz	IIIQ5 Double glazing 1;yes; 2;no; -9;missing
wlinol	IIIQ5 Linoleum floor 1;yes; 2;no; -9;missing
wPVC	IIIQ5 PVC (plastic) floor 1;yes; 2;no; -9;missing
wWoodflo	IIIQ5 Wooden floor 1;yes; 2;no; -9;missing

FIELD	Explanation and Coding
wWoodpan	IIIQ5 Wooden panels 1;yes; 2;no; -9;missing
wPlaster	IIIQ5 Plaster board walls/ceilings 1;yes; 2;no; -9;missing
wChipbrd	IIIQ5 Chipboard walls 1;yes; 2;no; -9;missing
wwallpap	IIIQ5 Wallpaper (any kind) 1;yes; 2;no; -9;missing
wnone1	IIIQ5 None above alternatives 1;yes; 2;no; -9;missing

FIELD	Explanation and Coding
workloc	IIIQ6 1=down town 2=suburban area w. high rises 3=suburban, small buildings 4=industrial area 5=other
workloct	IIIQ6 Work location explanation (if 5=other)
workb	IIIQ7 1=single family detached 2=single family, attached 3=office or appartement building 4=industrial building 5=other
workbt	IIIQ7 Work building type explanation (if 5=other)
wtraf	IIIQ8 Traffic volume on the nearby street 1=heavy, continuous, 2=medium, 3=light
whtraf	IIIQ9 Truck/heavy vehicle traffic volume on the nearby street 1=all the time 2=often 3=rarely 4=never
wbulyr	IIIQ10 1=after 1989 2=1980-89 3=1970-79 4=before 1970 5=don't know
wrenowal	IIIQ11 Wall painting/paper renovation in last year 1;yes; 2;no; -9;missing
wrenoflo	IIIQ11 Floor repair/polish/varnishing in last year 1;yes; 2;no; -9;missing
wrenowat	IIIQ11 Water/sewage system renovation in last year 1;yes; 2;no; -9;missing
wrenowin	IIIQ11 Window/door renovation in last year 1;yes; 2;no; -9;missing
wrenoins	IIIQ11 Insulation renovation in last year 1;yes; 2;no; -9;missing
wwallcon	IIIQ11 Wall construction/removal in last year 1;yes; 2;no; -9;missing
wnone2	IIIQ11 None above alternatives 1;yes; 2;no; -9;missing

FIELD	Coding
wwaterd	IIIQ12 Damages in previous question caused by water 1;yes; 2;no; 3;don't know; -9;missing
wwaterdn	IIIQ13 Is there any water damage that has not been fixed 1;yes; 2;no; 3;don't know; -9;missing
wheatdis	IIIQ14 Work heating: district heating 1;yes; 2;no; -9;missing
wheatcen	IIIQ14 Work heating: central heating in the building 1;yes; 2;no; -9;missing
wheatele	IIIQ14 Work heating: single stoves/heaters with electricity 1;yes; 2;no; -9;missing
wheatgas	IIIQ14 Work heating: single stoves/heaters with gas 1;yes; 2;no; -9;missing
wheatcoa	IIIQ14 Work heating: single stoves/heaters with coal 1;yes; 2;no; -9;missing
wheatwoo	IIIQ14 Work heating: single stoves/heaters with wood 1;yes; 2;no; -9;missing
wheatker	IIIQ14 Work heating: single stoves/heaters with kerosene/parafine 1;yes; 2;no; -9;missing
wheatoil	IIIQ14 Work heating: single stoves/heaters with fuel/oil 1;yes; 2;no; -9;missing
wheatfir	IIIQ14 Work heating: fire place 1;yes; 2;no; -9;missing

FIELD	Explanation and Coding
wheatnon	IIIQ14 Work heating: no heating 1;yes; 2;no; -9;missing
Wheatoth	IIIQ14 Other heating (specify) 1;yes; 2;no; -9;missing
Wheatott	IIIQ14 Work heating, explanation
Waircond	IIIQ15 Air conditioning in the home 1;yes; 2;no; -9;missing
Whumidif	IIIQ15 Humidifier in the home 1;yes; 2;no; -9;missing
Waircl	IIIQ15 Electric/filter cleaner or ionizer in the home 1;yes; 2;no; -9;missing
Wairnone	IIIQ15 None above 1;yes; 2;no; -9;missing
Plok	1;ok; 2;commented; 3;error
Comment	Comments for this record

7. EQ48hr

The data is available for DIARY and EXPOSURE samples.

FIELD	Explanation and Coding
cid	Customer ID for this person
usegas	IQ1 How long (decimal number, eg. 1.25 = 1h 15 min) was gas stove used?
Usecoal	IQ1 How long (decimal number, eg. 1.25 = 1h 15 min) was coal stove used?
Usewood	IQ1 How long (decimal number, eg. 1.25 = 1h 15 min) was wood stove used?
Usekero	IQ1 How long (decimal number, eg. 1.25 = 1h 15 min) was kerosene stove used?
Useoil	IQ1 How long (decimal number, eg. 1.25 = 1h 15 min) was oil stove used?
Usefire	IQ1 How long (decimal number, eg. 1.25 = 1h 15 min) was fire place used?
Usefan	IQ1 How long (decimal number, eg. 1.25 = 1h 15 min) was kitchen fan used?
Useair	IQ1 How long (decimal number, eg. 1.25 = 1h 15 min) was air conditioning used?
Usehum	IQ1 How long (decimal number, eg. 1.25 = 1h 15 min) was humidifier used?
Useairc	IQ1 How long (decimal number, eg. 1.25 = 1h 15 min) was air cleaner used?
Usegaswh	IQ1 How long (decimal number, eg. 1.25 = 1h 15 min) was gas water heater used?
Useeldr	IQ1 How long (decimal number, eg. 1.25 = 1h 15 min) was electric dryer used?
Usegasdr	IQ1 How long (decimal number, eg. 1.25 = 1h 15 min) was gas dryer used?
Usesauna	IQ1 How long (decimal number, eg. 1.25 = 1h 15 min) was wood heated sauna used?
Useelc	IQ1 How long (decimal number, eg. 1.25 = 1h 15 min) was electric cooking stove used?
Usegasc	IQ1 How long (decimal number, eg. 1.25 = 1h 15 min) was gas cooking stove used?
Usesolid	IQ1 How long (decimal number, eg. 1.25 = 1h 15 min) was solid fuel cooking stove used?
Vacuum	IQ2 Vacuum cleaning 1;yes I did ;2;yes, some one else did;3;no;-9;missing
chemical	IQ3 Brand names of cleaning chemicals
window	IQ4 How long (decimal number, eg. 1.25 = 1h 15 min) was a window open in the home?
Wusegas	IIQ1 How long (decimal number, eg. 1.25 = 1h 15 min) was gas stove used?
Wusecoal	IIQ1 How long (decimal number, eg. 1.25 = 1h 15 min) was coal stove used?
Wusewood	IIQ1 How long (decimal number, eg. 1.25 = 1h 15 min) was wood stove used?
Wusekero	IIQ1 How long (decimal number, eg. 1.25 = 1h 15 min) was kerosene stove used?
Wuseoil	IIQ1 How long (decimal number, eg. 1.25 = 1h 15 min) was oil stove used?
Wusefire	IIQ1 How long (decimal number, eg. 1.25 = 1h 15 min) was fire place used?
Wuseair	IIQ1 How long (decimal number, eg. 1.25 = 1h 15 min) was air conditioning used?
Wusehum	IIQ1 How long (decimal number, eg. 1.25 = 1h 15 min) was humidifier used?
Wuseairc	IIQ1 How long (decimal number, eg. 1.25 = 1h 15 min) was air cleaner used?
Wwindow	IIQ2 How long (decimal number, eg. 1.25 = 1h 15 min) was a window open in workplace?
Photoc	IIQ3 How long (decimal number, eg. 1.25 = 1h 15 min) was a photocopy machine or printer used?

FIELD	Explanation and Coding
photos	IIIQ1 Hours used to develop photographs
paint	IIIQ1 Hours used to paint
glue	IIIQ1 Hours used to glue
workshop	IIIQ1 Hours used in workshop
carwash	IIIQ1 Hours used to wash car
gasstat	IIIQ1 Hours used in gas station
gasoline	IIIQ1 1;gasoline;2;diesel;-9;missing
grilling	IIIQ1 Hours used to grill
garage	IIIQ1 Hours used in garage
exero	IIIQ1 Hours used to exercise outdoors
exeri	IIIQ1 Hours used to exercise indoors
hockey	IIIQ1 Hours used in icehockey ring
parfume	IIIQ2 Parfume use 1;yes;2;no;3;don't remember;-9;missing
drycloth	IIIQ2 Use of dry cleaned clothes 1;yes;2;no;3;don't remember;-9;missing
airpola	IVQ1 How much did the air pollutants annoy you in home 0-10
airpolc	IVQ2 1;dust;2;exhaust;3;chemicals;4;other (specify)
airpolt	IVQ2 other specify text
wairpola	IVQ1 How much did the air pollutants annoy you in work 0-10
wairpolc	IVQ2 1;dust;2;exhaust;3;chemicals;4;other (specify)
wairpolt	IVQ2 other specify text
tairpola	IVQ1 How much did the air pollutants annoy you in traffic 0-10
tairpolc	IVQ2 1;dust;2;exhaust;3;chemicals;4;other (specify)
tairpolt	IVQ2 other specify text
case	VQ1 Case with customer whole period 1;yes;2;no;-9;missing
caset	VQ1 When the case was not with the customer
p4ok	1;ok;2;commented;3;error
comment	Comments for this record
Eduyr	years of education, only in Grenoble, some data also in table PShortQ
Wheez	Wheezing or whistling during last 12 months, 1=yes, 2=no, 3=don't know. Only in Grenoble, some data also in table PShortQ.
Astma	Astma attack during last 12 months, 1=yes, 2=no, 3=don't know. Only in Grenoble, some data also in table PShortQ.
nasal	Nasal allergies, hay fever, 1=yes, 2=no, 3=don't know. Only in Grenoble, some data also in table PShortQ.

8. PM c

PM2.5 concentrations of all PM samples (including microenvironmental measurements).

FIELD	Explanation
sid	sample identification code
PM_c	"Best available" PM concentration 1. c_vntp 2. c_unVol (only PEM) 3. c_nom
PM_c_vntp	PM concentration corrected to NTP PEM: calculated using average measured flow, and average temperature (from Langan) and air pressure (from met station) of the sampling period MEM: calculated using average normalized flow. Also starting and/or ending flow measurements are normalized.
PM_c_unVol	PM concentration calculated using average measured flow. Only for PEM.
PM_c_Vnom	PM concentration calculated using nominal flows, nomf (PEM 4 l/min, MEM 16.7 l/min)
ok	Maximum of ok fields 1 ok 2 some problem (usable with care) 3 error (data not usable)
sok	Data cleaning ok field 1 ok 2 some problem 3 error

Grenoble: only personal 48 hr measurements available. Vpem (from query EFlows) used in calculations.

Milan: PEM data not applicable and MEM data has been calculated with Vnom (flow=16.7 l/min).

Oxford: PEM samplers were used in home indoor and work measurements.

More detailed description of calculations: see CQN PM2.5 - Calculating PM2.5 concentrations from the Expolis Database.

9. PM c P1P2P48IOW

PM concentrations calculated with "best available" PM concentrations (see 8. PM c) in each microenvironment for Exposure sample.

FIELD	Explanation
cid	Customer ID
PM_P1	Personal day PM2.5 exposure
PM_P2	Personal night PM2.5 exposure
PM_P48	Personal 2-day PM2.5 exposure
PM_I	Home indoor 32 hour concentration
PM_O	Home outdoor 32 hour concentration
PM_W	Work 16 hour concentration

More detailed description of calculations: see CQN PM2.5 - Calculating PM2.5 concentrations from the Expolis Database.

Oxford: PEM samplers were used in home indoor and work measurements.

10. NO₂ c

NO₂ concentrations of all NO₂ samples (including microenvironmental measurements).

FIELD	Explanation
sid	sample identification code
NO2_c	NO ₂ concentration
ok	1 ok 2 some problem (usable with care) 3 error (data not usable)
sok	Data cleaning ok field 1 ok 2 some problem 3 error

More detailed description of calculations: see CQN NO₂ - How to calculate NO₂ concentrations from the Expolis Database

Oxford: Badges were used in NO₂ measurements instead of Palmes tubes.

11. NO₂ c IOPW

NO₂ concentrations of Exposure sample.

FIELD	Explanation
cid	Customer ID
NO2_I	Home indoor 48 hour NO ₂ concentration
NO2_O	Home outdoor 48 hour NO ₂ concentration
NO2_P	Personal 48 hour NO ₂ exposure
NO2_W	Work 48 hour NO ₂ concentration

More detailed description of calculations: see CQN NO₂ - How to calculate NO₂ concentrations from the Expolis Database

Oxford: Badges were used in NO₂ measurements instead of Palmes tubes.

12. TMAD total minutes

Time microenvironment activity diary data of Exposure and Diary samples.

FIELD	Explanation
cid	Customer ID
walk	Nr of minutes walking during 48 hours
moto	Nr of minutes motorcycling during 48 hours
car	Nr of minutes car during 48 hours
bus	Nr of minutes bus during 48 hours
train	Nr of minutes train during 48 hours
hi	Nr of minutes home indoors during 48 hours
ho	Nr of minutes home outdoors during 48 hours
wi	Nr of minutes work indoors during 48 hours
wo	Nr of minutes work outdoors during 48 hours
oi	Nr of minutes other indoor locations during 48 hours
oo	Nr of minutes other outdoor locations during 48 hours
ac	Nr of minutes cooking during 48 hours
as	Nr of minutes smoking during 48 hours
ar	Nr of minutes in same room with smoking during 48 hours

Grenoble: because of the different study design in Grenoble, here are also results of people which exposure results are not in this database because they are not comparable to results of other centers.

13. VOC compounds

FIELD	Explanation
CASnr	CASnr of VOC
grp	Group of compound (like alcohols, aromatics, etc)
name	Name of VOC
Merck	Merck Index (12th ed) monograph number
et	This compound is Expolis target? 1 yes, 0 no

14. VOC c

VOC concentrations of all measurements (also microenvironmental)

FIELD	Explanation
sid	sample identification code
CASnr	CASnr of VOC
VOC_c	VOC concentration (ng/m ³)
LODok	1 ok 2 half of the detection limit used in the calculations
fok	Flow ok 1 ok, 2 some problems, 3 error
Sok	Data cleaning 1 ok, 2 some problem (usable with care), 3 error (data not usable)
Dok	Dur ok 1 ok, 2 some problems, 3 error

Milan: VOC results calculated only for MEMs. 1.61 ml/min flow have been used in calculations.

Oxford: PEM samplers were used in home indoor and work measurements.

Also other than target VOCs data available for Basel. Other centers data of other than target VOCs available in the local databases. **Notice** No detection limits applied to non target VOC data in the local databases.

More detailed description of calculations: see CQN VOC - How to calculate VOC concentrations from the Expolis Database

15. VOC I

Home indoor concentrations of Expolis target VOCs for Exposure sample.

FIELD	Explanation
Cid	Customer ID
I_000066-25-1	Home/Indoor/ Hexanal concentration (ng/m ³)
I_000071-36-3	Home/Indoor/ 1-butanol concentration (ng/m ³)
I_000071-43-2	Home/Indoor/ Benzene concentration (ng/m ³)
I_000078-83-1	Home/Indoor/ 2-methyl-1-propanol concentration (ng/m ³)
I_000079-00-5	Home/Indoor/ 1,1,2-trichloroethane concentration (ng/m ³)
I_000079-01-6	Home/Indoor/ Trichloroethene concentration (ng/m ³)
I_000080-56-8	Home/Indoor/ alfa-pinene concentration (ng/m ³)
I_000091-20-3	Home/Indoor/ Naphtalene concentration (ng/m ³)
I_000095-47-6	Home/Indoor/ Home/Indoor/ o-xylene concentration (ng/m ³)
I_000095-63-6	Home/Indoor/ Trimethylbenzenes concentration (ng/m ³)
I_000100-41-4	Home/Indoor/ Ethylbenzene concentration (ng/m ³)
I_000100-42-5	Home/Indoor/ Styrene concentration (ng/m ³)
I_000100-52-7	Home/Indoor/ Benzaldehyde concentration (ng/m ³)
I_000103-65-1	Home/Indoor/ Propylbenzene concentration (ng/m ³)
I_000104-76-7	Home/Indoor/ 2-ethylhexanol concentration (ng/m ³)
I_000108-38-3	Home/Indoor/ m(&p)-xylene concentration (ng/m ³)
I_000108-88-3	Home/Indoor/ Toluene concentration (ng/m ³)
I_000108-95-2	Home/Indoor/ Phenol concentration (ng/m ³)
I_000110-54-3	Home/Indoor/ Hexane concentration (ng/m ³)
I_000110-82-7	Home/Indoor/ Cyclohexane concentration (ng/m ³)
I_000111-76-2	Home/Indoor/ ethanol, 2-butoxy- concentration (ng/m ³)
I_000111-84-2	Home/Indoor/ Nonane concentration (ng/m ³)
I_000111-87-5	Home/Indoor/ 1-octanol concentration (ng/m ³)
I_000124-13-0	Home/Indoor/ Octanal concentration (ng/m ³)
I_000124-18-5	Home/Indoor/ Decane concentration (ng/m ³)
I_000127-18-4	Home/Indoor/ Tetrachloroethene concentration (ng/m ³)
I_000138-86-3	Home/Indoor/ d-limonene concentration (ng/m ³)
I_000872-50-4	Home/Indoor/ 2-pyrrolidinone, 1-methyl- concentration (ng/m ³)
I_001120-21-4	Home/Indoor/ Undecane concentration (ng/m ³)
I_013466-78-9	Home/Indoor/ 3-carene concentration (ng/m ³)
I_TVOC	Home/Indoor/ Toluene based total VOC concentration (ng/m ³)

Note: This data contains also values below the detection limit (see table VOC c, Field LODok). If you want to use only values above the detection limit, you have to collect the data (with queries) from table VOC c.

Milan: 1.61 ml/min flow have been used in calculations.

Oxford: PEM samplers were used in home indoor measurements.

16. VOC O

Home outdoor concentrations of Expolis target VOCs for Exposure sample

FIELD	Explanation
Cid	Customer ID
O_000066-25-1	Home/Outdoor/ Hexanal concentration (ng/m ³)
O_000071-36-3	Home/Outdoor/ 1-butanol concentration (ng/m ³)
O_000071-43-2	Home/Outdoor/ Benzene concentration (ng/m ³)
O_000078-83-1	Home/Outdoor/ 2-methyl-1-propanol concentration (ng/m ³)
O_000079-00-5	Home/Outdoor/ 1,1,2-trichloroethane concentration (ng/m ³)
O_000079-01-6	Home/Outdoor/ Trichloroethene concentration (ng/m ³)
O_000080-56-8	Home/Outdoor/ alfa-pinene concentration (ng/m ³)
O_000091-20-3	Home/Outdoor/ Naphtalene concentration (ng/m ³)
O_000095-47-6	Home/Outdoor/ o-xylene concentration (ng/m ³)
O_000095-63-6	Home/Outdoor/ Trimethylbenzenes concentration (ng/m ³)
O_000100-41-4	Home/Outdoor/ Ethylbenzene concentration (ng/m ³)
O_000100-42-5	Home/Outdoor/ Styrene concentration (ng/m ³)
O_000100-52-7	Home/Outdoor/ Benzaldehyde concentration (ng/m ³)
O_000103-65-1	Home/Outdoor/ Propylbenzene concentration (ng/m ³)
O_000104-76-7	Home/Outdoor/ 2-ethylhexanol concentration (ng/m ³)
O_000108-38-3	Home/Outdoor/ m(&p)-xylene concentration (ng/m ³)
O_000108-88-3	Home/Outdoor/ Toluene concentration (ng/m ³)
O_000108-95-2	Home/Outdoor/ Phenol concentration (ng/m ³)
O_000110-54-3	Home/Outdoor/ Hexane concentration (ng/m ³)
O_000110-82-7	Home/Outdoor/ Cyclohexane concentration (ng/m ³)
O_000111-76-2	Home/Outdoor/ ethanol, 2-butoxy- concentration (ng/m ³)
O_000111-84-2	Home/Outdoor/ Nonane concentration (ng/m ³)
O_000111-87-5	Home/Outdoor/ 1-octanol concentration (ng/m ³)
O_000124-13-0	Home/Outdoor/ Octanal concentration (ng/m ³)
O_000124-18-5	Home/Outdoor/ Decane concentration (ng/m ³)
O_000127-18-4	Home/Outdoor/ Tetrachloroethene concentration (ng/m ³)
O_000138-86-3	Home/Outdoor/ d-limonene concentration (ng/m ³)
O_000872-50-4	Home/Outdoor/ 2-pyrrolidinone, 1-methyl- concentration (ng/m ³)
O_001120-21-4	Home/Outdoor/ Undecane concentration (ng/m ³)
O_013466-78-9	Home/Outdoor/ 3-carene concentration (ng/m ³)
O_TVOC	Home/Outdoor/ Toluene based total VOC concentration (ng/m ³)

Note: This data contains also values below the detection limit (see table VOC c, Field LODok). If you want to use only values above the detection limit, you have to collect the data (with queries) from table VOC c.

Milan: 1.61 ml/min flow have been used in calculations.

17. VOC P

Personal concentrations of Expolis target VOCs for Exposure sample

FIELD	Explanation
Cid	Customer ID
P_000066-25-1	Personal/ Hexanal concentration (ng/m ³)
P_000071-36-3	Personal/ 1-butanol concentration (ng/m ³)
P_000071-43-2	Personal/ Benzene concentration (ng/m ³)
P_000078-83-1	Personal/ 2-methyl-1-propanol concentration (ng/m ³)
P_000079-00-5	Personal/ 1,1,2-trichloroethane concentration (ng/m ³)
P_000079-01-6	Personal/ Trichloroethene concentration (ng/m ³)
P_000080-56-8	Personal/ alfa-pinene concentration (ng/m ³)
P_000091-20-3	Personal/ Naphtalene concentration (ng/m ³)
P_000095-47-6	Personal/ o-xylene concentration (ng/m ³)
P_000095-63-6	Personal/ Trimethylbenzenes concentration (ng/m ³)
P_000100-41-4	Personal/ Ethylbenzene concentration (ng/m ³)
P_000100-42-5	Personal/ Styrene concentration (ng/m ³)
P_000100-52-7	Personal/ Benzaldehyde concentration (ng/m ³)
P_000103-65-1	Personal/ Propylbenzene concentration (ng/m ³)
P_000104-76-7	Personal/ 2-ethylhexanol concentration (ng/m ³)
P_000108-38-3	Personal/ m(&p)-xylene concentration (ng/m ³)
P_000108-88-3	Personal/ Toluene concentration (ng/m ³)
P_000108-95-2	Personal/ Phenol concentration (ng/m ³)
P_000110-54-3	Personal/ Hexane concentration (ng/m ³)
P_000110-82-7	Personal/ Cyclohexane concentration (ng/m ³)
P_000111-76-2	Personal/ ethanol, 2-butoxy- concentration (ng/m ³)
P_000111-84-2	Personal/ Nonane concentration (ng/m ³)
P_000111-87-5	Personal/ 1-octanol concentration (ng/m ³)
P_000124-13-0	Personal/ Octanal concentration (ng/m ³)
P_000124-18-5	Personal/ Decane concentration (ng/m ³)
P_000127-18-4	Personal/ Tetrachloroethene concentration (ng/m ³)
P_000138-86-3	Personal/ d-limonene concentration (ng/m ³)
P_000872-50-4	Personal/ 2-pyrrolidinone, 1-methyl- concentration (ng/m ³)
P_001120-21-4	Personal/ Undecane concentration (ng/m ³)
P_013466-78-9	Personal/ 3-carene concentration (ng/m ³)
P_TVOC	Personal/ Toluene based total VOC concentration (ng/m ³)

Note: This data contains also values below the detection limit (see table VOC c, Field LODok). If you want to use only values above the detection limit, you have to collect the data (with queries) from table VOC c.

Milan: No Milan data available.

18. VOC W

Work indoor concentrations of Expolis target VOCs for Exposure sample

FIELD	Explanation
Cid	Customer ID
W_000066-25-1	Work/ Hexanal concentration (ng/m ³)
W_000071-36-3	Work/ 1-butanol concentration (ng/m ³)
W_000071-43-2	Work/ Benzene concentration (ng/m ³)
W_000078-83-1	Work/ 2-methyl-1-propanol concentration (ng/m ³)
W_000079-00-5	Work/ 1,1,2-trichloroethane concentration (ng/m ³)
W_000079-01-6	Work/ Trichloroethene concentration (ng/m ³)
W_000080-56-8	Work/ alfa-pinene concentration (ng/m ³)
W_000091-20-3	Work/ Naphtalene concentration (ng/m ³)
W_000095-47-6	Work/ o-xylene concentration (ng/m ³)
W_000095-63-6	Work/ Trimethylbenzenes concentration (ng/m ³)
W_000100-41-4	Work/ Ethylbenzene concentration (ng/m ³)
W_000100-42-5	Work/ Styrene concentration (ng/m ³)
W_000100-52-7	Work/ Benzaldehyde concentration (ng/m ³)
W_000103-65-1	Work/ Propylbenzene concentration (ng/m ³)
W_000104-76-7	Work/ 2-ethylhexanol concentration (ng/m ³)
W_000108-38-3	Work/ m(&p)-xylene concentration (ng/m ³)
W_000108-88-3	Work/ Toluene concentration (ng/m ³)
W_000108-95-2	Work/ Phenol concentration (ng/m ³)
W_000110-54-3	Work/ Hexane concentration (ng/m ³)
W_000110-82-7	Work/ Cyclohexane concentration (ng/m ³)
W_000111-76-2	Work/ ethanol, 2-butoxy- concentration (ng/m ³)
W_000111-84-2	Work/ Nonane concentration (ng/m ³)
W_000111-87-5	Work/ 1-octanol concentration (ng/m ³)
W_000124-13-0	Work/ Octanal concentration (ng/m ³)
W_000124-18-5	Work/ Decane concentration (ng/m ³)
W_000127-18-4	Work/ Tetrachloroethene concentration (ng/m ³)
W_000138-86-3	Work/ d-limonene concentration (ng/m ³)
W_000872-50-4	Work/ 2-pyrrolidinone, 1-methyl- concentration (ng/m ³)
W_001120-21-4	Work/ Undecane concentration (ng/m ³)
W_013466-78-9	Work/ 3-carene concentration (ng/m ³)
W_TVOC	Work/ Toluene based total VOC concentration (ng/m ³)

Note: This data contains also values below the detection limit (see table VOC c, Field LODok). If you want to use only values above the detection limit, you have to collect the data (with queries) from table VOC c.

Milan: 1.61 ml/min flow have been used in calculations.

Oxford: PEM samplers were used in work measurements.

19. CO c

CO concentrations of Exposure sample.

FIELD	Explanation
cid	Customer id
CO48h	48 hour CO average (mg/m ³)
CO8hmax	Maximum running 8 hour concentration (mg/m ³)
CO1hmax	Maximum running 1 hour concentration (mg/m ³)
Start	Start of the measurement period dd.mm.yy hh:mm
End	End of the measurement period dd.mm.yy hh:mm

Milan: different protocols were used to calculate CO levels. The calculations were done in separate database. Local database of Milan do not produce CO levels presented in this table. CO levels are not temperature corrected.

More detailed description of calculations: see Expolis local CO database: User's Manual and Expolis local CO database: User's Instructions for Updating to version 9811.

20. EAS c

Elemental concentrations of all PM2.5 samples (also microenvironmental).

FIELD	Explanation
sid	sample identification code
element	Name of the element
EAS_c	elemental concentration (ng/m ³)
EAS_massc	Elemental massconcentration (ng/mg)
Position	Position of the sample on sampler changer
EAS_DL	1="correct value" 2= half of the detection limit has been used
Sok	Data cleaning 1 ok, 2 some problem (usable with care), 3 error (data not usable)
Ok	Volume ok 1 ok, 2 some problems, 3 error
Mok	Mass ok 1 ok, 2 some problems, 3 error

More detailed description of calculations: see CQN VOC - How to calculate EAS concentrations from the Expolis Database

Grenoble: only personal 48 hr measurements available. Vpem (from query EFlows) used in calculations.

Prague: only P1, I, O data available.

Milan: only I, O, W data available.

Notice: The results of sulphur (S) are under consturction because of problems in quality assurance.

21. EAS c I

Home indoor elemental concentrations of Exposure sample.

FIELD	Explanation
Cid	Customer ID
cI_Ag	Home Indoor/ Silver concentration (ng/m ³)
cI_Al	Home Indoor/ Aluminium concentration (ng/m ³)
cI_As	Home Indoor/ Arsenic concentration (ng/m ³)
cI_Ba	Home Indoor/ Barium concentration (ng/m ³)
cI_Br	Home Indoor/ Bromine concentration (ng/m ³)
cI_Ca	Home Indoor/ Calcium concentration (ng/m ³)
cI_Cd	Home Indoor/ Cadmium concentration (ng/m ³)
cI_Cl	Home Indoor/ Chlorine concentration (ng/m ³)
cI_Co	Home Indoor/ Cobalt concentration (ng/m ³)
cI_Cr	Home Indoor/ Chromium concentration (ng/m ³)
cI_Cu	Home Indoor/ Copper concentration (ng/m ³)
cI_Fe	Home Indoor/ Iron concentration (ng/m ³)
cI_Ga	Home Indoor/ Gallium concentration (ng/m ³)
cI_Ge	Home Indoor/ Germanium concentration (ng/m ³)
cI_Hg	Home Indoor/ Mercury concentration (ng/m ³)
cI_I	Home Indoor/ Iodine concentration (ng/m ³)
cI_K	Home Indoor/ Potassium concentration (ng/m ³)
cI_Mg	Home Indoor/ Magnesium concentration (ng/m ³)
cI_Mn	Home Indoor/ Manganese concentration (ng/m ³)
cI_Na	Home Indoor/ Sodium concentration (ng/m ³)
cI_Ni	Home Indoor/ Nickel concentration (ng/m ³)
cI_P	Home Indoor/ Phosphorus concentration (ng/m ³)
cI_Pb	Home Indoor/ Lead concentration (ng/m ³)
cI_Rb	Home Indoor/ Rubidium concentration (ng/m ³)
cI_S	Home Indoor/ Sulphur concentration (ng/m ³) <i>Under construction!</i>
cI_Sb	Home Indoor/ Antimony concentration (ng/m ³)
cI_Se	Home Indoor/ Selenium concentration (ng/m ³)
cI_Si	Home Indoor/ Silicon concentration (ng/m ³)
cI_Sm	Home Indoor/ Samarium concentration (ng/m ³)
cI_Sn	Home Indoor/ Tin concentration (ng/m ³)
cI_Sr	Home Indoor/ Strontium concentration (ng/m ³)
cI_Ti	Home Indoor/ Titanium concentration (ng/m ³)
cI_Tl	Home Indoor/ Thallium concentration (ng/m ³)
cI_Tm	Home Indoor/ Thulium concentration (ng/m ³)
cI_V	Home Indoor/ Vanadium concentration (ng/m ³)
cI_Zn	Home Indoor/ Zinc concentration (ng/m ³)
cI_Zr	Home Indoor/ Zirconium concentration (ng/m ³)

Note: This data contains also values below the detection limit (see table EAS c, Field EAS_DL). If you want to use only values above the detection limit, you have to collect the data (with queries) from table EAS c. If only one filter out of two possible filters of "Vallila type measurement" (in Helsinki and Athens) have been analyzed this table do not give you the result. Use EAS c table to collect that data if needed.

Grenoble: No Grenoble data available.

22. EAS c O

Home outdoor elemental concentrations of Exposure sample.

FIELD	Explanation
Cid	Customer ID
cO_Ag	Home Outdoor/ Silver concentration (ng/m ³)
cO_Al	Home Outdoor/ Aluminium concentration (ng/m ³)
cO_As	Home Outdoor/ Arsenic concentration (ng/m ³)
cO_Ba	Home Outdoor/ Barium concentration (ng/m ³)
cO_Br	Home Outdoor/ Bromine concentration (ng/m ³)
cO_Ca	Home Outdoor/ Calcium concentration (ng/m ³)
cO_Cd	Home Outdoor/ Cadmium concentration (ng/m ³)
cO_Cl	Home Outdoor/ Chlorine concentration (ng/m ³)
cO_Co	Home Outdoor/ Cobalt concentration (ng/m ³)
cO_Cr	Home Outdoor/ Chromium concentration (ng/m ³)
cO_Cu	Home Outdoor/ Copper concentration (ng/m ³)
cO_Fe	Home Outdoor/ Iron concentration (ng/m ³)
cO_Ga	Home Outdoor/ Gallium concentration (ng/m ³)
cO_Ge	Home Outdoor/ Germanium concentration (ng/m ³)
cO_Hg	Home Outdoor/ Mercury concentration (ng/m ³)
cO_I	Home Outdoor/ Iodine concentration (ng/m ³)
cO_K	Home Outdoor/ Potassium concentration (ng/m ³)
cO_Mg	Home Outdoor/ Magnesium concentration (ng/m ³)
cO_Mn	Home Outdoor/ Manganese concentration (ng/m ³)
cO_Na	Home Outdoor/ Sodium concentration (ng/m ³)
cO_Ni	Home Outdoor/ Nickel concentration (ng/m ³)
cO_P	Home Outdoor/ Phosphorus concentration (ng/m ³)
cO_Pb	Home Outdoor/ Lead concentration (ng/m ³)
cO_Rb	Home Outdoor/ Rubidium concentration (ng/m ³)
cO_S	Home Outdoor/ Sulphur concentration (ng/m ³) <i>Under construction!</i>
cO_Sb	Home Outdoor/ Antimony concentration (ng/m ³)
cO_Se	Home Outdoor/ Selenium concentration (ng/m ³)
cO_Si	Home Outdoor/ Silicon concentration (ng/m ³)
cO_Sm	Home Outdoor/ Samarium concentration (ng/m ³)
cO_Sn	Home Outdoor/ Tin concentration (ng/m ³)
cO_Sr	Home Outdoor/ Strontium concentration (ng/m ³)
cO_Ti	Home Outdoor/ Titanium concentration (ng/m ³)
cO_Tl	Home Outdoor/ Thallium concentration (ng/m ³)
cO_Tm	Home Outdoor/ Thulium concentration (ng/m ³)
cO_V	Home Outdoor/ Vanadium concentration (ng/m ³)
cO_Zn	Home Outdoor/ Zinc concentration (ng/m ³)
cO_Zr	Home Outdoor/ Zirconium concentration (ng/m ³)

Note: This data contains also values below the detection limit (see table EAS c, Field EAS_DL). If you want to use only values above the detection limit, you have to collect the data (with queries) from table EAS c. If only one filter out of two possible filters of "Vallila type measurement" (in Helsinki and Athens) have been analyzed this table do not give you the result. Use EAS c table to collect that data if needed.

Grenoble: No Grenoble data available.

23. EAS c W

Work indoor elemental concentrations of Exposure sample.

FIELD	Explanation
Cid	Customer ID
cW_Ag	Work/ Silver concentration (ng/m ³)
cW_Al	Work/ Aluminium concentration (ng/m ³)
cW_As	Work/ Arsenic concentration (ng/m ³)
cW_Ba	Work/ Barium concentration (ng/m ³)
cW_Br	Work/ Bromine concentration (ng/m ³)
cW_Ca	Work/ Calcium concentration (ng/m ³)
cW_Cd	Work/ Cadmium concentration (ng/m ³)
cW_Cl	Work/ Chlorine concentration (ng/m ³)
cW_Co	Work/ Cobalt concentration (ng/m ³)
cW_Cr	Work/ Chromium concentration (ng/m ³)
cW_Cu	Work/ Copper concentration (ng/m ³)
cW_Fe	Work/ Iron concentration (ng/m ³)
cW_Ga	Work/ Gallium concentration (ng/m ³)
cW_Ge	Work/ Germanium concentration (ng/m ³)
cW_Hg	Work/ Mercury concentration (ng/m ³)
cW_I	Work/ Iodine concentration (ng/m ³)
cW_K	Work/ Potassium concentration (ng/m ³)
cW_Mg	Work/ Magnesium concentration (ng/m ³)
cW_Mn	Work/ Manganese concentration (ng/m ³)
cW_Na	Work/ Sodium concentration (ng/m ³)
cW_Ni	Work/ Nickel concentration (ng/m ³)
cW_P	Work/ Phosphorus concentration (ng/m ³)
cW_Pb	Work/ Lead concentration (ng/m ³)
cW_Rb	Work/ Rubidium concentration (ng/m ³)
cW_S	Work/ Sulphur concentration (ng/m ³) <i>Under construction!</i>
cW_Sb	Work/ Antimony concentration (ng/m ³)
cW_Se	Work/ Selenium concentration (ng/m ³)
cW_Si	Work/ Silicon concentration (ng/m ³)
cW_Sm	Work/ Samarium concentration (ng/m ³)
cW_Sn	Work/ Tin concentration (ng/m ³)
cW_Sr	Work/ Strontium concentration (ng/m ³)
cW_Ti	Work/ Titanium concentration (ng/m ³)
cW_Tl	Work/ Thallium concentration (ng/m ³)
cW_Tm	Work/ Thulium concentration (ng/m ³)
cW_V	Work/ Vanadium concentration (ng/m ³)
cW_Zn	Work/ Zinc concentration (ng/m ³)
cW_Zr	Work/ Zirconium concentration (ng/m ³)

Note: This data contains also values below the detection limit (see table EAS c, Field EAS_DL). If you want to use only values above the detection limit, you have to collect the data (with queries) from table EAS c. If only one filter out of two possible filters of "Vallila type measurement" (in Helsinki and Athens) have been analyzed this table do not give you the result. Use EAS c table to collect that data if needed.

Grenoble: No Grenoble data available.

Prague: No Prague data available

24. EAS c P1

Personal day elemental concentrations of Exposure sample.

FIELD	Explanation
Cid	Customer ID
cP1_Ag	Personal day/ Silver concentration (ng/m ³)
cP1_Al	Personal day/ Aluminium concentration (ng/m ³)
cP1_As	Personal day/ Arsenic concentration (ng/m ³)
cP1_Ba	Personal day/ Barium concentration (ng/m ³)
cP1_Br	Personal day/ Bromine concentration (ng/m ³)
cP1_Ca	Personal day/ Calcium concentration (ng/m ³)
cP1_Cd	Personal day/ Cadmium concentration (ng/m ³)
cP1_Cl	Personal day/ Chlorine concentration (ng/m ³)
cP1_Co	Personal day/ Cobalt concentration (ng/m ³)
cP1_Cr	Personal day/ Chromium concentration (ng/m ³)
cP1_Cu	Personal day/ Copper concentration (ng/m ³)
cP1_Fe	Personal day/ Iron concentration (ng/m ³)
cP1_Ga	Personal day/ Gallium concentration (ng/m ³)
cP1_Ge	Personal day/ Germanium concentration (ng/m ³)
cP1_Hg	Personal day/ Mercury concentration (ng/m ³)
cP1_I	Personal day/ Iodine concentration (ng/m ³)
cP1_K	Personal day/ Potassium concentration (ng/m ³)
cP1_Mg	Personal day/ Magnesium concentration (ng/m ³)
cP1_Mn	Personal day/ Manganese concentration (ng/m ³)
cP1_Na	Personal day/ Sodium concentration (ng/m ³)
cP1_Ni	Personal day/ Nickel concentration (ng/m ³)
cP1_P	Personal day/ Phosphorus concentration (ng/m ³)
cP1_Pb	Personal day/ Lead concentration (ng/m ³)
cP1_Rb	Personal day/ Rubidium concentration (ng/m ³)
cP1_S	Personal day/ Sulphur concentration (ng/m ³) <i>Under construction!</i>
cP1_Sb	Personal day/ Antimony concentration (ng/m ³)
cP1_Se	Personal day/ Selenium concentration (ng/m ³)
cP1_Si	Personal day/ Silicon concentration (ng/m ³)
cP1_Sm	Personal day/ Samarium concentration (ng/m ³)
cP1_Sn	Personal day/ Tin concentration (ng/m ³)
cP1_Sr	Personal day/ Strontium concentration (ng/m ³)
cP1_Ti	Personal day/ Titanium concentration (ng/m ³)
cP1_Tl	Personal day/ Thallium concentration (ng/m ³)
cP1_Tm	Personal day/ Thulium concentration (ng/m ³)
cP1_V	Personal day/ Vanadium concentration (ng/m ³)
cP1_Zn	Personal day/ Zinc concentration (ng/m ³)
cP1_Zr	Personal day/ Zirconium concentration (ng/m ³)

Note: This data contains also values below the detection limit (see table EAS c, Field EAS_DL). If you want to use only values above the detection limit, you have to collect the data (with queries) from table EAS c.

No Milan and Grenoble data.

25. EAS c P2

Personal night elemental concentrations of Exposure sample.

FIELD	Explanation
Cid	Customer ID
cP2_Ag	Personal night/ Silver concentration (ng/m ³)
cP2_Al	Personal night/ Aluminium concentration (ng/m ³)
cP2_As	Personal night/ Arsenic concentration (ng/m ³)
cP2_Ba	Personal night/ Barium concentration (ng/m ³)
cP2_Br	Personal night/ Bromine concentration (ng/m ³)
cP2_Ca	Personal night/ Calcium concentration (ng/m ³)
cP2_Cd	Personal night/ Cadmium concentration (ng/m ³)
cP2_Cl	Personal night/ Chlorine concentration (ng/m ³)
cP2_Co	Personal night/ Cobalt concentration (ng/m ³)
cP2_Cr	Personal night/ Chromium concentration (ng/m ³)
cP2_Cu	Personal night/ Copper concentration (ng/m ³)
cP2_Fe	Personal night/ Iron concentration (ng/m ³)
cP2_Ga	Personal night/ Gallium concentration (ng/m ³)
cP2_Ge	Personal night/ Germanium concentration (ng/m ³)
cP2_Hg	Personal night/ Mercury concentration (ng/m ³)
cP2_I	Personal night/ Iodine concentration (ng/m ³)
cP2_K	Personal night/ Potassium concentration (ng/m ³)
cP2_Mg	Personal night/ Magnesium concentration (ng/m ³)
cP2_Mn	Personal night/ Manganese concentration (ng/m ³)
cP2_Na	Personal night/ Sodium concentration (ng/m ³)
cP2_Ni	Personal night/ Nickel concentration (ng/m ³)
cP2_P	Personal night/ Phosphorus concentration (ng/m ³)
cP2_Pb	Personal night/ Lead concentration (ng/m ³)
cP2_Rb	Personal night/ Rubidium concentration (ng/m ³)
cP2_S	Personal night/ Sulphur concentration (ng/m ³) <i>Under construction!</i>
cP2_Sb	Personal night/ Antimony concentration (ng/m ³)
cP2_Se	Personal night/ Selenium concentration (ng/m ³)
cP2_Si	Personal night/ Silicon concentration (ng/m ³)
cP2_Sm	Personal night/ Samarium concentration (ng/m ³)
cP2_Sn	Personal night/ Tin concentration (ng/m ³)
cP2_Sr	Personal night/ Strontium concentration (ng/m ³)
cP2_Ti	Personal night/ Titanium concentration (ng/m ³)
cP2_Tl	Personal night/ Thallium concentration (ng/m ³)
cP2_Tm	Personal night/ Thulium concentration (ng/m ³)
cP2_V	Personal night/ Vanadium concentration (ng/m ³)
cP2_Zn	Personal night/ Zinc concentration (ng/m ³)
cP2_Zr	Personal night/ Zirconium concentration (ng/m ³)

Note: This data contains also values below the detection limit (see table EAS c, Field EAS_DL). If you want to use only values above the detection limit, you have to collect the data (with queries) from table EAS c.

No Milan, Prague and Grenoble data.

26. EAS c P48

Personal 2-day elemental concentrations of Exposure sample.

FIELD	Explanation
Cid	Customer ID
cP48_Ag	Personal 2-day/ Silver concentration (ng/m ³)
cP48_Al	Personal 2-day/ Aluminium concentration (ng/m ³)
cP48_As	Personal 2-day/ Arsenic concentration (ng/m ³)
cP48_Ba	Personal 2-day/ Barium concentration (ng/m ³)
cP48_Br	Personal 2-day/ Bromine concentration (ng/m ³)
cP48_Ca	Personal 2-day/ Calcium concentration (ng/m ³)
cP48_Cd	Personal 2-day/ Cadmium concentration (ng/m ³)
cP48_Cl	Personal 2-day/ Chlorine concentration (ng/m ³)
cP48_Co	Personal 2-day/ Cobalt concentration (ng/m ³)
cP48_Cr	Personal 2-day/ Chromium concentration (ng/m ³)
cP48_Cu	Personal 2-day/ Copper concentration (ng/m ³)
cP48_Fe	Personal 2-day/ Iron concentration (ng/m ³)
cP48_Ga	Personal 2-day/ Gallium concentration (ng/m ³)
cP48_Ge	Personal 2-day/ Germanium concentration (ng/m ³)
cP48_Hg	Personal 2-day/ Mercury concentration (ng/m ³)
cP48_I	Personal 2-day/ Iodine concentration (ng/m ³)
cP48_K	Personal 2-day/ Potassium concentration (ng/m ³)
cP48_Mg	Personal 2-day/ Magnesium concentration (ng/m ³)
cP48_Mn	Personal 2-day/ Manganese concentration (ng/m ³)
cP48_Na	Personal 2-day/ Sodium concentration (ng/m ³)
cP48_Ni	Personal 2-day/ Nickel concentration (ng/m ³)
cP48_P	Personal 2-day/ Phosphorus concentration (ng/m ³)
cP48_Pb	Personal 2-day/ Lead concentration (ng/m ³)
cP48_Rb	Personal 2-day/ Rubidium concentration (ng/m ³)
cP48_S	Personal 2-day/ Sulphur concentration (ng/m ³) <i>Under construction!</i>
cP48_Sb	Personal 2-day/ Antimony concentration (ng/m ³)
cP48_Se	Personal 2-day/ Selenium concentration (ng/m ³)
cP48_Si	Personal 2-day/ Silicon concentration (ng/m ³)
cP48_Sm	Personal 2-day/ Samarium concentration (ng/m ³)
cP48_Sn	Personal 2-day/ Tin concentration (ng/m ³)
cP48_Sr	Personal 2-day/ Strontium concentration (ng/m ³)
cP48_Ti	Personal 2-day/ Titanium concentration (ng/m ³)
cP48_Tl	Personal 2-day/ Thallium concentration (ng/m ³)
cP48_Tm	Personal 2-day/ Thulium concentration (ng/m ³)
cP48_V	Personal 2-day/ Vanadium concentration (ng/m ³)
cP48_Zn	Personal 2-day/ Zinc concentration (ng/m ³)
cP48_Zr	Personal 2-day/ Zirconium concentration (ng/m ³)

Note: Because P48 have been calculated as time weighted average of P1 and P2, either might be below the detection limit. If you want to use only values above the detection limit, you have to collect the data (with queries) from table EAS c.

No Milan and Prague data.

27. EAS massc I

Home indoor elemental massconcentrations of Exposure sample.

FIELD	Explanation
Cid	Customer ID
masscI_Ag	Home Indoor/ Silver massconcentration (ng/mg)
masscI_Al	Home Indoor/ Aluminium massconcentration (ng/mg)
masscI_As	Home Indoor/ Arsenic massconcentration (ng/mg)
masscI_Ba	Home Indoor/ Barium massconcentration (ng/mg)
masscI_Br	Home Indoor/ Bromine massconcentration (ng/mg)
masscI_Ca	Home Indoor/ Calcium massconcentration (ng/mg)
masscI_Cd	Home Indoor/ Cadmium massconcentration (ng/mg)
masscI_Cl	Home Indoor/ Chlorine massconcentration (ng/mg)
masscI_Co	Home Indoor/ Cobalt massconcentration (ng/mg)
masscI_Cr	Home Indoor/ Chromium massconcentration (ng/mg)
masscI_Cu	Home Indoor/ Copper massconcentration (ng/mg)
masscI_Fe	Home Indoor/ Iron massconcentration (ng/mg)
masscI_Ga	Home Indoor/ Gallium massconcentration (ng/mg)
masscI_Ge	Home Indoor/ Germanium massconcentration (ng/mg)
masscI_Hg	Home Indoor/ Mercury massconcentration (ng/mg)
masscI_I	Home Indoor/ Iodine massconcentration (ng/mg)
masscI_K	Home Indoor/ Potassium massconcentration (ng/mg)
masscI_Mg	Home Indoor/ Magnesium massconcentration (ng/mg)
masscI_Mn	Home Indoor/ Manganese massconcentration (ng/mg)
masscI_Na	Home Indoor/ Sodium massconcentration (ng/mg)
masscI_Ni	Home Indoor/ Nickel massconcentration (ng/mg)
masscI_P	Home Indoor/ Phosphorus massconcentration (ng/mg)
masscI_Pb	Home Indoor/ Lead massconcentration (ng/mg)
masscI_Rb	Home Indoor/ Rubidium massconcentration (ng/mg)
masscI_S	Home Indoor/ Sulphur massconcentration (ng/mg) <i>Under construction!</i>
masscI_Sb	Home Indoor/ Antimony massconcentration (ng/mg)
masscI_Se	Home Indoor/ Selenium massconcentration (ng/mg)
masscI_Si	Home Indoor/ Silicon massconcentration (ng/mg)
masscI_Sm	Home Indoor/ Samarium massconcentration (ng/mg)
masscI_Sn	Home Indoor/ Tin massconcentration (ng/mg)
masscI_Sr	Home Indoor/ Strontium massconcentration (ng/mg)
masscI_Ti	Home Indoor/ Titanium massconcentration (ng/mg)
masscI_Tl	Home Indoor/ Thallium massconcentration (ng/mg)
masscI_Tm	Home Indoor/ Thulium massconcentration (ng/mg)
masscI_V	Home Indoor/ Vanadium massconcentration (ng/mg)
masscI_Zn	Home Indoor/ Zinc concentration (ng/mg)
masscI_Zr	Home Indoor/ Zirconium massconcentration (ng/mg)

Note: This data contains also values below the detection limit (see table EAS c, Field EAS_DL). If you want to use only values above the detection limit, you have to collect the data (with queries) from table EAS c. If only one filter out of two possible filters of "Vallila type measurement" (in Helsinki and Athens) have been analyzed this table do not give you the result. Use EAS c table to collect that data if needed.

Grenoble: No Grenoble data available.

28. EAS massc O

Home outdoor elemental massconcentrations of Exposure sample.

FIELD	Explanation
Cid	Customer ID
masscO_Ag	Home Outdoor/ Silver massconcentration (ng/mg)
masscO_Al	Home Outdoor/ Aluminium massconcentration (ng/mg)
masscO_As	Home Outdoor/ Arsenic massconcentration (ng/mg)
masscO_Ba	Home Outdoor/ Barium massconcentration (ng/mg)
masscO_Br	Home Outdoor/ Bromine massconcentration (ng/mg)
masscO_Ca	Home Outdoor/ Calcium massconcentration (ng/mg)
masscO_Cd	Home Outdoor/ Cadmium massconcentration (ng/mg)
masscO_Cl	Home Outdoor/ Chlorine massconcentration (ng/mg)
masscO_Co	Home Outdoor/ Cobalt massconcentration (ng/mg)
masscO_Cr	Home Outdoor/ Chromium massconcentration (ng/mg)
masscO_Cu	Home Outdoor/ Copper massconcentration (ng/mg)
masscO_Fe	Home Outdoor/ Iron massconcentration (ng/mg)
masscO_Ga	Home Outdoor/ Gallium massconcentration (ng/mg)
masscO_Ge	Home Outdoor/ Germanium massconcentration (ng/mg)
masscO_Hg	Home Outdoor/ Mercury massconcentration (ng/mg)
masscO_I	Home Outdoor/ Iodine massconcentration (ng/mg)
masscO_K	Home Outdoor/ Potassium massconcentration (ng/m)
masscO_Mg	Home Outdoor/ Magnesium massconcentration (ng/mg)
masscO_Mn	Home Outdoor/ Manganese massconcentration (ng/mg)
masscO_Na	Home Outdoor/ Sodium massconcentration (ng/mg)
masscO_Ni	Home Outdoor/ Nickel massconcentration (ng/mg)
masscO_P	Home Outdoor/ Phosphorus massconcentration (ng/mg)
masscO_Pb	Home Outdoor/ Lead massconcentration (ng/mg)
masscO_Rb	Home Outdoor/ Rubidium massconcentration (ng/mg)
masscO_S	Home Outdoor/ Sulphur massconcentration (ng/mg) <i>Under construction!</i>
masscO_Sb	Home Outdoor/ Antimony massconcentration (ng/mg)
masscO_Se	Home Outdoor/ Selenium massconcentration (ng/mg)
masscO_Si	Home Outdoor/ Silicon massconcentration (ng/mg)
masscO_Sm	Home Outdoor/ Samarium massconcentration (ng/mg)
masscO_Sn	Home Outdoor/ Tin massconcentration (ng/mg)
masscO_Sr	Home Outdoor/ Strontium massconcentration (ng/mg)
masscO_Ti	Home Outdoor/ Titanium massconcentration (ng/mg)
masscO_Tl	Home Outdoor/ Thallium massconcentration (ng/mg)
masscO_Tm	Home Outdoor/ Thulium massconcentration (ng/mg)
masscO_V	Home Outdoor/ Vanadium massconcentration (ng/mg)
masscO_Zn	Home Outdoor/ Zinc concentration (ng/mg)
masscO_Zr	Home Outdoor/ Zirconium massconcentration (ng/mg)

Note: This data contains also values below the detection limit (see table EAS c, Field EAS_DL). If you want to use only values above the detection limit, you have to collect the data (with queries) from table EAS c. If only one filter out of two possible filters of "Vallila type measurement" (in Helsinki and Athens) have been analyzed this table do not give you the result. Use EAS c table to collect that data if needed.

Grenoble: No Grenoble data available.

29. EAS massc W

Work indoor elemental massconcentrations of Exposure sample.

FIELD	Explanation
Cid	Customer ID
masscW_Ag	Work/ Silver massconcentration (ng/mg)
masscW_Al	Work/ Aluminium massconcentration (ng/mg)
masscW_As	Work/ Arsenic massconcentration (ng/mg)
masscW_Ba	Work/ Barium massconcentration (ng/mg)
masscW_Br	Work/ Bromine massconcentration (ng/mg)
masscW_Ca	Work/ Calcium massconcentration (ng/mg)
masscW_Cd	Work/ Cadmium massconcentration (ng/mg)
masscW_Cl	Work/ Chlorine massconcentration (ng/mg)
masscW_Co	Work/ Cobalt massconcentration (ng/mg)
masscW_Cr	Work/ Chromium massconcentration (ng/mg)
masscW_Cu	Work/ Copper massconcentration (ng/mg)
masscW_Fe	Work/ Iron massconcentration (ng/mg)
masscW_Ga	Work/ Gallium massconcentration (ng/mg)
masscW_Ge	Work/ Germanium massconcentration (ng/mg)
masscW_Hg	Work/ Mercury massconcentration (ng/mg)
masscW_I	Work/ Iodine massconcentration (ng/mg)
masscW_K	Work/ Potassium massconcentration (ng/mg)
masscW_Mg	Work/ Magnesium massconcentration (ng/mg)
masscW_Mn	Work/ Manganese massconcentration (ng/mg)
masscW_Na	Work/ Sodium massconcentration (ng/mg)
masscW_Ni	Work/ Nickel massconcentration (ng/mg)
masscW_P	Work/ Phosphorus massconcentration (ng/mg)
masscW_Pb	Work/ Lead massconcentration (ng/mg)
masscW_Rb	Work/ Rubidium massconcentration (ng/mg)
masscW_S	Work/ Sulphur massconcentration (ng/mg) <i>Under construction!</i>
masscW_Sb	Work/ Antimony massconcentration (ng/mg)
masscW_Se	Work/ Selenium massconcentration (ng/mg)
masscW_Si	Work/ Silicon massconcentration (ng/mg)
masscW_Sm	Work/ Samarium massconcentration (ng/mg)
masscW_Sn	Work/ Tin massconcentration (ng/mg)
masscW_Sr	Work/ Strontium massconcentration (ng/mg)
masscW_Ti	Work/ Titanium massconcentration (ng/mg)
masscW_Tl	Work/ Thallium massconcentration (ng/mg)
masscW_Tm	Work/ Thulium massconcentration (ng/mg)
masscW_V	Work/ Vanadium massconcentration (ng/mg)
masscW_Zn	Work/ Zinc concentration (ng/mg)
masscW_Zr	Work/ Zirconium massconcentration (ng/mg)

Note: This data contains also values below the detection limit (see table EAS c, Field EAS_DL). If you want to use only values above the detection limit, you have to collect the data (with queries) from table EAS c. If only one filter out of two possible filters of "Vallila type measurement" (in Helsinki and Athens) have been analyzed this table do not give you the result. Use EAS c table to collect that data if needed.

No Grenoble and Prague data available.

30. EAS massc P1

Personal day elemental massconcentrations of Exposure sample.

FIELD	Explanation
Cid	Customer ID
masscP1_Ag	Personal day/ Silver massconcentration (ng/mg)
masscP1_Al	Personal day/ Aluminium massconcentration (ng/mg)
masscP1_As	Personal day/ Arsenic massconcentration (ng/mg)
masscP1_Ba	Personal day/ Barium massconcentration (ng/mg)
masscP1_Br	Personal day/ Bromine massconcentration (ng/mg)
masscP1_Ca	Personal day/ Calcium massconcentration (ng/mg)
masscP1_Cd	Personal day/ Cadmium massconcentration (ng/mg)
masscP1_Cl	Personal day/ Chlorine massconcentration (ng/mg)
masscP1_Co	Personal day/ Cobalt massconcentration (ng/mg)
masscP1_Cr	Personal day/ Chromium massconcentration (ng/mg)
masscP1_Cu	Personal day/ Copper massconcentration (ng/mg)
masscP1_Fe	Personal day/ Iron massconcentration (ng/mg)
masscP1_Ga	Personal day/ Gallium massconcentration (ng/mg)
masscP1_Ge	Personal day/ Germanium massconcentration (ng/mg)
masscP1_Hg	Personal day/ Mercury massconcentration (ng/mg)
masscP1_I	Personal day/ Iodine massconcentration (ng/mg)
masscP1_K	Personal day/ Potassium massconcentration (ng/mg)
masscP1_Mg	Personal day/ Magnesium massconcentration (ng/mg)
masscP1_Mn	Personal day/ Manganese massconcentration (ng/mg)
masscP1_Na	Personal day/ Sodium massconcentration (ng/mg)
masscP1_Ni	Personal day/ Nickel massconcentration (ng/mg)
masscP1_P	Personal day/ Phosphorus massconcentration (ng/mg)
masscP1_Pb	Personal day/ Lead massconcentration (ng/mg)
masscP1_Rb	Personal day/ Rubidium massconcentration (ng/mg)
masscP1_S	Personal day/ Sulphur massconcentration (ng/mg) <i>Under construction!</i>
masscP1_Sb	Personal day/ Antimony massconcentration (ng/mg)
masscP1_Se	Personal day/ Selenium massconcentration (ng/mg)
masscP1_Si	Personal day/ Silicon massconcentration (ng/mg)
masscP1_Sm	Personal day/ Samarium massconcentration (ng/mg)
masscP1_Sn	Personal day/ Tin massconcentration (ng/mg)
masscP1_Sr	Personal day/ Strontium massconcentration (ng/mg)
masscP1_Ti	Personal day/ Titanium massconcentration (ng/mg)
masscP1_Tl	Personal day/ Thallium massconcentration (ng/mg)
masscP1_Tm	Personal day/ Thulium massconcentration (ng/mg)
masscP1_V	Personal day/ Vanadium massconcentration (ng/mg)
masscP1_Zn	Personal day/ Zinc concentration (ng/mg)
masscP1_Zr	Personal day/ Zirconium massconcentration (ng/mg)

Note: This data contains also values below the detection limit (see table EAS c, Field EAS_DL). If you want to use only values above the detection limit, you have to collect the data (with queries) from table EAS c.

No Milan and Grenoble data.

31. EAS massc P2

Personal night elemental massconcentrations of Exposure sample.

FIELD	Explanation
Cid	Customer ID
masscP2_Ag	Personal night/ Silver massconcentration (ng/mg)
masscP2_Al	Personal night/ Aluminium massconcentration (ng/mg)
masscP2_As	Personal night/ Arsenic massconcentration (ng/mg)
masscP2_Ba	Personal night/ Barium massconcentration (ng/mg)
masscP2_Br	Personal night/ Bromine massconcentration (ng/mg)
masscP2_Ca	Personal night/ Calcium massconcentration (ng/mg)
masscP2_Cd	Personal night/ Cadmium massconcentration (ng/mg)
masscP2_Cl	Personal night/ Chlorine massconcentration (ng/mg)
masscP2_Co	Personal night/ Cobalt massconcentration (ng/mg)
masscP2_Cr	Personal night/ Chromium massconcentration (ng/mg)
masscP2_Cu	Personal night/ Copper massconcentration (ng/mg)
masscP2_Fe	Personal night/ Iron massconcentration (ng/mg)
masscP2_Ga	Personal night/ Gallium massconcentration (ng/mg)
masscP2_Ge	Personal night/ Germanium massconcentration (ng/mg)
masscP2_Hg	Personal night/ Mercury massconcentration (ng/mg)
masscP2_I	Personal night/ Iodine massconcentration (ng/mg)
masscP2_K	Personal night/ Potassium massconcentration (ng/mg)
masscP2_Mg	Personal night/ Magnesium massconcentration (ng/mg)
masscP2_Mn	Personal night/ Manganese massconcentration (ng/mg)
masscP2_Na	Personal night/ Sodium massconcentration (ng/mg)
masscP2_Ni	Personal night/ Nickel massconcentration (ng/mg)
masscP2_P	Personal night/ Phosphorus massconcentration (ng/mg)
masscP2_Pb	Personal night/ Lead massconcentration (ng/mg)
masscP2_Rb	Personal night/ Rubidium massconcentration (ng/mg)
masscP2_S	Personal night/ Sulphur massconcentration (ng/mg) <i>Under construction!</i>
masscP2_Sb	Personal night/ Antimony massconcentration (ng/mg)
masscP2_Se	Personal night/ Selenium massconcentration (ng/mg)
masscP2_Si	Personal night/ Silicon massconcentration (ng/mg)
masscP2_Sm	Personal night/ Samarium massconcentration (ng/mg)
masscP2_Sn	Personal night/ Tin massconcentration (ng/mg)
masscP2_Sr	Personal night/ Strontium massconcentration (ng/mg)
masscP2_Ti	Personal night/ Titanium massconcentration (ng/mg)
masscP2_Tl	Personal night/ Thallium massconcentration (ng/mg)
masscP2_Tm	Personal night/ Thulium massconcentration (ng/mg)
masscP2_V	Personal night/ Vanadium massconcentration (ng/mg)
masscP2_Zn	Personal night/ Zinc concentration (ng/mg)
masscP2_Zr	Personal night/ Zirconium massconcentration (ng/mg)

Note: This data contains also values below the detection limit (see table EAS c, Field EAS_DL). If you want to use only values above the detection limit, you have to collect the data (with queries) from table EAS c.

No Milan, Prague and Grenoble data.

32. EAS massc P48

Personal 2-day elemental massconcentrations of Exposure sample.

FIELD	Explanation
Cid	Customer ID
masscP48_Ag	Personal 2-day/ Silver massconcentration (ng/mg)
masscP48_Al	Personal 2-day/ Aluminium massconcentration (ng/mg)
masscP48_As	Personal 2-day/ Arsenic massconcentration (ng/mg)
masscP48_Ba	Personal 2-day/ Barium massconcentration (ng/mg)
masscP48_Br	Personal 2-day/ Bromine massconcentration (ng/mg)
masscP48_Ca	Personal 2-day/ Calcium massconcentration (ng/mg)
masscP48_Cd	Personal 2-day/ Cadmium massconcentration (ng/mg)
masscP48_Cl	Personal 2-day/ Chlorine massconcentration (ng/mg)
masscP48_Co	Personal 2-day/ Cobalt massconcentration (ng/mg)
masscP48_Cr	Personal 2-day/ Chromium massconcentration (ng/mg)
masscP48_Cu	Personal 2-day/ Copper massconcentration (ng/mg)
masscP48_Fe	Personal 2-day/ Iron massconcentration (ng/mg)
masscP48_Ga	Personal 2-day/ Gallium massconcentration (ng/mg)
masscP48_Ge	Personal 2-day/ Germanium massconcentration (ng/mg)
masscP48_Hg	Personal 2-day/ Mercury massconcentration (ng/mg)
masscP48_I	Personal 2-day/ Iodine massconcentration (ng/mg)
masscP48_K	Personal 2-day/ Potassium massconcentration (ng/mg)
masscP48_Mg	Personal 2-day/ Magnesium massconcentration (ng/mg)
masscP48_Mn	Personal 2-day/ Manganese massconcentration (ng/mg)
masscP48_Na	Personal 2-day/ Sodium massconcentration (ng/mg)
masscP48_Ni	Personal 2-day/ Nickel massconcentration (ng/mg)
masscP48_P	Personal 2-day/ Phosphorus massconcentration (ng/mg)
masscP48_Pb	Personal 2-day/ Lead massconcentration (ng/mg)
masscP48_Rb	Personal 2-day/ Rubidium massconcentration (ng/mg)
masscP48_S	Personal 2-day/ Sulphur massconcentration (ng/mg) <i>Under construction!</i>
masscP48_Sb	Personal 2-day/ Antimony massconcentration (ng/mg)
masscP48_Se	Personal 2-day/ Selenium massconcentration (ng/mg)
masscP48_Si	Personal 2-day/ Silicon massconcentration (ng/mg)
masscP48_Sm	Personal 2-day/ Samarium massconcentration (ng/mg)
masscP48_Sn	Personal 2-day/ Tin massconcentration (ng/mg)
masscP48_Sr	Personal 2-day/ Strontium massconcentration (ng/mg)
masscP48_Ti	Personal 2-day/ Titanium massconcentration (ng/mg)
masscP48_Tl	Personal 2-day/ Thallium massconcentration (ng/mg)
masscP48_Tm	Personal 2-day/ Thulium massconcentration (ng/mg)
masscP48_V	Personal 2-day/ Vanadium massconcentration (ng/mg)
masscP48_Zn	Personal 2-day/ Zinc concentration (ng/mg)
masscP48_Zr	Personal 2-day/ Zirconium massconcentration (ng/mg)

Note: Because P48 have been calculated as time weighted average of P1 and P2, either might be below the detection limit. If you want to use only values above the detection limit, you have to collect the data (with queries) from table EAS c.

No Milan and Prague data.

33. FIXEDRUNS

FIELD	Explanation
Sid	Sample identification code
Site	Fixed station measurement site, See separate document on CD-ROM.
Comp	Fixed station component. See below.
Avg	Average value for the Expolis sample run period(s)
Min	Minimum value for the Expolis sample run period(s)
Max	Maximum value for the Expolis sample run period(s)
Stdev	Standard deviation of value for the Expolis sample run period(s)
Cov	Number of hourly fixed station observations per duration of Expolis sample (in hours)x100
N	Number non-null fixed station observations

Component	Comp	
SO ₂ ,	SO2	Hourly average of sulphur dioxide concentration [$\mu\text{g}/\text{m}^3$]
NO	NO	Hourly average of nitrogen oxide concentration [$\mu\text{g}/\text{m}^3$]
NO ₂ ,	NO2	Hourly average of nitrogen dioxide concentration [$\mu\text{g}/\text{m}^3$]
O ₃ ,	O3	Hourly average of ozone concentration [$\mu\text{g}/\text{m}^3$]
PM ₁₀	PM10	Hourly average of PM ₁₀ concentration [$\mu\text{g}/\text{m}^3$]
PM _{2.5}	PM2_5	Hourly average of PM _{2.5} concentration [$\mu\text{g}/\text{m}^3$]
TSP	TSP	Hourly average of particulate matter concentration [$\mu\text{g}/\text{m}^3$]
CO	CO	Hourly average of carbon monoxide concentration [mg/m^3]
Wind speed	Wspd	[m/s]
Wind direction	Wdir	0-360° (0 = N, 90 = E)
Temperature	Temp	[°C]
Rain	Rain	[%] (Percentage of time having rain during each hour)
Relative humidity	Rhum	[%]
Air pressure	pres	[hPa], Instant value observed in 3-hour intervals, clock 0, 3, 6, ... in GMT
Cloudiness	clou	[1/8],--
Relative humidity	hum	[%],--
Air temperature	temp	[°C],--
TDEW	tdew	[°C],--
TWET	twet	[°C],--
Visibility	visi	[m],--
Wind direction	widd	° (0-360, N=0, E=90), 10 minute average observed in 3-hour intervals) Wind direction is the direction from which the wind is blowing
Wind speed	wims	[m/s],--
Mixing height	[m]	3-hourly value
Monin-Obhukov inverse length	[1/m]	--

Grenoble daily average values in the folder Additional data of CIDB Sept 02 (CD-ROM)

34. PM BS

Absorption coefficients of PM2.5 samples.

FIELD	Explanation
Sid	Sample identification code
BS	Absorption coefficient of PM2.5 sample (1/m)
Volok	Volume ok? 1=ok 2=some problem (usable with care) 3=error (data not usable)
Sok	Data cleaning ok field 1=ok 2=some problem (usable with care) 3=error (data not usable)

Milan: only MEM data

Grenoble: only P48 data

Basel and Helsinki y-joint samples: average of filters and formula $([A]/[V_{best}] * (\text{Log}(100/[ref4_{ave}])))$ have been used in calculations.

Oxford: No Oxford data

More detailed description of calculations: see CQN: BlackSmoke in Expolis database.

35. PM BS IOWP1P2P48

Absorption coefficients of PM2.5 samples for Exposure sample

FIELD	Explanation
cid	Customer id
BS_I	Home Indoor absorption coefficient of PM2.5 sample (1/m)
BS_O	Home Outdoor absorption coefficient of PM2.5 sample (1/m)
BS_W	Work absorption coefficient of PM2.5 sample (1/m)
BS_P1	Personal day absorption coefficient of PM2.5 sample (1/m)
BS_P2	Personal night absorption coefficient of PM2.5 sample (1/m)
BS_P48	Personal 2-day absorption coefficient of PM2.5 sample (1/m)

Milan: Only MEM data.

Grenoble Only BS_P48

Oxford: No Oxford data

Note: P48 is the time weighted average of P1 and P2.
